

MS2650/MS2660B/C Series  
Spectrum Analyzer  
Operation Manual  
Vol. 2  
(Detailed Operating Instructions)

Fifth Edition

**Read this manual before using the equipment.  
Keep this manual with the equipment.**

Measurement Solutions  
**ANRITSU CORPORATION**

JUL.  
2001

Document No.: M-W1251AE-5.0

# Safety Symbols

To prevent the risk of personal injury or loss related to equipment malfunction, Anritsu Corporation uses the following safety symbols to indicate safety-related information. Insure that you clearly understand the meanings of the symbols BEFORE using the equipment.

## Symbols used in manual

**DANGER** 

This indicates a very dangerous procedure that could result in serious injury or death if not performed properly.

**WARNING** 

This indicates a hazardous procedure that could result in serious injury or death if not performed properly.

**CAUTION** 

This indicates a hazardous procedure or danger that could result in light-to-severe injury, or loss related to equipment malfunction, if proper precautions are not taken.

## Safety Symbols Used on Equipment and in Manual

(Some or all of the following five symbols may not be used on all Anritsu equipment. In addition, there may be other labels attached to products which are not shown in the diagrams in this manual.)

The following safety symbols are used inside or on the equipment near operation locations to provide information about safety items and operation precautions. Insure that you clearly understand the meanings of the symbols and take the necessary precautions BEFORE using the equipment.



This indicates a prohibited operation. The prohibited operation is indicated symbolically in or near the barred circle.



This indicates an obligatory safety precaution. The obligatory operation is indicated symbolically in or near the circle.



This indicates warning or caution. The contents are indicated symbolically in or near the triangle.



This indicates a note. The contents are described in the box.



These indicate that the marked part should be recycled.

MS2650/MS2660B/C Series Spectrum Analyzer

Operation Manual Vol. 2 (Detailed Operating Instructions)

14 March 1997 (First Edition)

16 March 2001 (Fifth Edition)

Copyright © 1997-2001, ANRITSU CORPORATION.

All rights reserved. No part of this manual may be reproduced without the prior written permission of the publisher.

The contents of this manual may be changed without prior notice.

Printed in Japan

## For Safety

### WARNING



1. ALWAYS refer to the operation manual when working near locations at which the alert mark shown on the left is attached. If the operation, etc., is performed without heeding the advice in the operation manual, there is a risk of personal injury. In addition, the equipment performance may be reduced.

Moreover, this alert mark is sometimes used with other marks and descriptions indicating other dangers.



2. When supplying power to this equipment, connect the accessory 3-pin power cord to a 3-pin grounded power outlet. If a grounded 3-pin outlet is not available, before supplying power to the equipment, use a conversion adapter and ground the green wire, or connect the frame ground on the rear panel of the equipment to ground. If power is supplied without grounding the equipment, there is a risk of receiving a severe or fatal electric shock. In addition, there is a risk of damage to internal circuits of this equipment.

Repair

**WARNING** 

3. This equipment cannot be repaired by the user. DO NOT attempt to open the cabinet or to disassemble internal parts. Only Anritsu-trained service personnel or staff from your sales representative with a knowledge of electrical fire and shock hazards should service this equipment. There are high-voltage parts in this equipment presenting a risk of severe injury or fatal electric shock to untrained personnel. In addition, there is a risk of damage to precision parts.

Falling Over

4. This equipment should be used in the correct position. If the cabinet is turned on its side, etc., it will be unstable and may be damaged if it falls over as a result of receiving a slight mechanical shock.

## For Safety

### WARNING

---

LCD

5. This instrument uses a Liquid Crystal Display (LCD); DO NOT subject the instrument to excessive force or drop it. If the LCD is subjected to strong mechanical shock, it may break and liquid may leak.

This liquid is very caustic and poisonous.

DO NOT touch it, ingest it, or get in your eyes. If it is ingested accidentally, spit it out immediately, rinse your mouth with water and seek medical help. If it enters your eyes accidentally, do not rub your eyes, irrigate them with clean running water and seek medical help. If the liquid gets on your skin or clothes, wash it off carefully and thoroughly.

Battery fluid

6. DO NOT short the battery terminals and never attempt to disassemble it or dispose of it in a fire. If the battery is damaged by any of these actions, the battery fluid may leak.

This fluid is poisonous.

DO NOT touch it, ingest it, or get in your eyes. If it is accidentally ingested, spit it out immediately, rinse your mouth with water and seek medical help. If it enters your eyes accidentally, do not rub your eyes, irrigate them with clean running water and seek medical help. If the liquid gets on your skin or clothes, wash it off carefully and thoroughly.

---

## For Safety

### CAUTION

#### Changing Fuse

#### CAUTION

#### Cleaning

#### Input level



1. Before changing the fuses, ALWAYS remove the power cord from the power outlet and replace the blown fuses. ALWAYS use new fuses of the type and rating specified on the fuse marking on the rear panel of the cabinet.

T5A indicates a time-lag fuse.

There is risk of receiving a fatal electric shock if the fuses are replaced with the power cord connected.

2. Keep the power inlet and cooling fan free of dust.
  - Clean the power inlet regularly. If dust accumulates around the power pins, there is a risk of fire.
  - Keep the cooling fan clean so that the ventilation holes are not obstructed. If the ventilation is obstructed, the cabinet may overheat and catch fire.

3. ◆MS2651B/2661B/2661C (standard:50Ω)
  - Maximum DC voltage ratings:
    - RF Input       ±DC 50 V
    - TG Output      ±DC 0 V
  - Maximum AC power (continuous wave) ratings:
    - RF Input       +30 dBm (RF ATT ≥10 dB)
    - TG Output      +20 dBm

*NEVER input a over maximum ratings to RF Input and TG Output, excessive power may damage the internal circuits.*

- ◆MS2651B/2661B/2661C (plus opt. 08 preamplifier ON)
  - Maximum DC voltage ratings:
    - RF Input       ±DC 50 V
  - Maximum AC power (continuous wave) ratings:
    - RF Input       +10 dBm (RF ATT ≥10 dB)

*NEVER input a over maximum ratings to RF Input, excessive power may damage the internal circuits.*

## For Safety

◆MS2651B/2661B/2661C (plus opt. 19 DC Input)

- Maximum DC voltage ratings:  
RF Input       $\pm$ DC 0 V
- Maximum AC power (continuous wave) ratings:  
RF Input      +30 dBm (RF ATT  $\geq$ 10 dB)

*NEVER input a over maximum ratings to RF Input, excessive power may damage the internal circuits.*

◆MS2651B/2661B/2661C (plus opt. 22, 23:75 $\Omega$  Input, 75 $\Omega$  TG)

- Maximum DC voltage ratings:  
RF Input       $\pm$ DC 100 V  
TG Output      $\pm$ DC 0 V
- Maximum AC power (continuous wave) ratings:  
RF Input      +25 dBm (RF ATT  $\geq$ 10 dB)  
TG Output     +20 dBm

*NEVER input a over maximum ratings to RF Input and TG Output, excessive power may damage the internal circuits.*

◆MS2653B/2663B/2663C

- Maximum DC voltage ratings:  
RF Input       $\pm$ DC 0 V
- Maximum AC power (continuous wave) ratings:  
RF Input      +30 dBm (RF ATT  $\geq$ 10 dB)

*NEVER input a over maximum ratings to RF Input, excessive power may damage the internal circuits.*

◆MS2653B/2663B/2663C (plus opt. 8 preamplifier ON)

- Maximum DC voltage ratings:  
RF Input       $\pm$ DC 50 V
- Maximum AC power (continuous wave) ratings:  
RF Input      +10 dBm (RF ATT  $\geq$ 10 dB)

*NEVER input a over maximum ratings to RF Input, excessive power may damage the internal circuits.*

## For Safety

- ◆ RF Input/TG Output connector
- MS2651B/2661B/2661C/2653B/2663B/2663C (standard:50Ω)
  - RF Input      N-J
  - TG Output    N-J
- MS2651B/2661B/2661C (plus opt. 22, 23:75Ω)
  - RF Input      NC-J
  - TG Output    NC-J

*NEVER connect a difference type connector, Connecting a difference type may damage the connector.*

---

## For Safety

### CAUTION

#### Replacing Memory Back-up Battery

4. The power for memory back-up is supplied by a Poly-carbonmonofluoride Lithium Battery. This battery should only be replaced by a battery of the same type; since replacement can only be made by Anritsu, contact the nearest Anritsu representative when replacement is required.

*Note: The Battery life is about 7 years. Early battery replacement is recommended.*

#### Storage Medium

5. This equipment stores data and programs using Plug-in Memory card (MC).

Data and programs may be lost due to improper use or failure. ANRITSU therefore recommends that you back-up the memory.

Anritsu Corporation will not accept liability for lost data.

Please pay careful attention to the following points.

- Do not remove the IC card from equipment being accessed.
- Isolate the card from static electricity.
- The back-up battery in the SRAM memory card has a limited life; replace the battery periodically.

#### Disposing of The Product

6. This equipment uses chemical compound semiconductor including arsenide.

At the end of its life, the equipment should be recycled or disposed properly according to the local disposal regulations.



# Equipment Certificate

Anritsu Corporation certifies that this equipment was tested before shipment using calibrated measuring instruments with direct traceability to public testing organizations recognized by national research laboratories including the Electrotechnical Laboratory, the National Research Laboratory of Metrology and the Communications Research laboratory, and was found to meet the published specifications.

## Anritsu Warranty

Anritsu Corporation will repair this equipment free-of-charge if a malfunction occurs within 1 year after shipment due to a manufacturing fault, provided that this warranty is rendered void under any or all of the following conditions.

- The fault is outside the scope of the warranty conditions described in the operation manual.
- The fault is due to misoperation, misuse, or unauthorized modification or repair of the equipment by the customer.
- The fault is due to severe usage clearly exceeding normal usage.
- The fault is due to improper or insufficient maintenance by the customer.
- The fault is due to natural disaster including fire, flooding and earthquake, etc.
- The fault is due to use of non-specified peripheral equipment, peripheral parts, consumables, etc.
- The fault is due to use of a non-specified power supply or in a non-specified installation location.

In addition, this warranty is valid only for the original equipment purchaser. It is not transferable if the equipment is resold.

Anritsu Corporation will not accept liability for equipment faults due to unforeseen and unusual circumstances, nor for faults due to mishandling by the customer.

## Anritsu Corporation Contact

If this equipment develops a fault, contact the head office of Anritsu Corporation at the address in the operation manual, or your nearest sales or service office listed on the following pages.

---

## Front Panel Power Switch

---

To prevent malfunction caused by accidental touching, the front power switch of this equipment turns on the power if it is pressed continuously for about one second in the standby state. If the switch is pressed continuously for one second in the power-on state, the equipment enters the standby state.

In the power-on state, if the power plug is removed from the outlet, then reinserted into it, the power will not be turned on. Also, if the lines is disconnected due to momentary power supply interruption or power failure, the power will not be turned on (enters the standby state) even if the line is recovered.

This is because this equipment enters the standby state and prevents incorrect data from being acquired when the line has to be disconnected and reconnected.

For example, if the sweep time is 1,000 seconds and data acquisition requires a long time, momentary power supply interruption (power failure) might occur during measurement and the line could be recovered automatically to power-on. In such a case, the equipment may mistake incorrect data for correct data without recognizing the momentary power supply interruption.

If this equipment enters the standby state due to momentary power supply interruption or power failure, check the state of the measuring system and press the front power switch to restore power to this equipment.

Further, if this equipment is built into a system and the system power has to be disconnected then reconnected, the power for this equipment must also be restored by pressing the front power switch.

Consequently, if this equipment is built into remote monitoring systems that use MODEMs, the standby function of this equipment must be modified.

-----  
**ABOUT DETECTION MODE**  
 -----

This instrument is a spectrum analyzer which uses a digital storage system. The spectrum analyzer makes level measurements in frequency steps obtained by dividing the frequency span by the number of measurement data points (501). This method of measurement cannot detect the signal peak level if the spectrum of a received signal is narrower than these frequency steps.

To resolve this problem, this instrument usually operates in positive peak detection mode and normal detection mode. In the positive peak detection mode, the highest level within the frequency range between the sample points can be held and traced. In the normal detection mode, both the positive peak and the negative peak can be traced.

Positive peak detection mode should be used for almost all measurements including normal signal level measurement, pulsed noise analysis, and others. It is impossible to measure the signal level accurately in sample detection mode or in negative peak detection mode.

Use of sample detection mode is restricted to random noise measurement, occupied frequency bandwidth measurement for analog communication systems, and adjacent-channel leakage power measurement, etc.

Measurement	item
• Normal signal .....	POS PEAK
• Random noise .....	SAMPLE
• Pulsed noise .....	NORMAL (POSI-NEG)
• Occupied frequency bandwidth, adjacent-channel leakage power .....	SAMPLE
(for analog communication systems)	
• Occupied frequency bandwidth, adjacent-channel leakage power .....	POS PEAK or SAMPLE
(for digital communication systems)	

When a detection mode is specified as one of the measurement methods, make the measurement in the specified detection mode.

-----  
**RBW Filter Characteristics and Auto Sweep Mode**  
**(MS2651B/2661B/2653B/2663B)**  
 -----

This spectrum analyzer use the filter with better selectivity (sharp skirt characteristics) than that of the old Anritsu spectrum analyzers.

As shown below, when filters have the same RBW (3 dB bandwidth), the filter with better selectivity can more accurately analyze the nearby spurious signal.

For example, the RBW 1 kHz of this spectrum analyzer corresponds to the RBW 300 Hz of the old types. Moreover, in the low frequency, the decrease of the level-measurement dynamic range by the zero-beat effect (caused by the filter skirt characteristics) is also improved.

Input signal

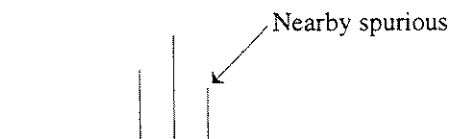

Filter with better selectivity



Trace waveform

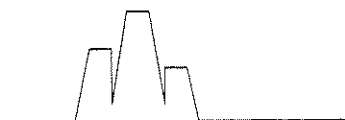

Filter with worse selectivity

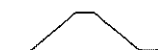

Trace waveform

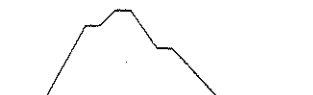

When in the same combination of the RBW and span, this spectrum analyzer auto sweep time in the Hi-Lvl-Acc mode becomes slower than that of the old type, by 3 times.

However, since this spectrum analyzer use the filter with better selectivity (sharp skirt characteristics), the wider RBW by 3 times can be set in the same span, and conversely, the sweep time can be set faster by 3 times for the high-accurate level measurement.

RBW = 1 kHz    ST = 400 ms  
SPAN = 50 kHz

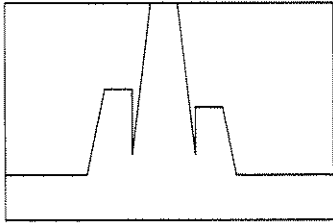

MS2651B/2661B/2653B/2663B  
in Hi-Lvl-Acc mode

RBW = 300 Hz    ST = 1.5 s  
SPAN = 50 kHz

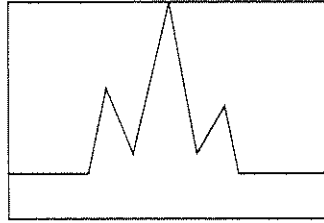

Old types

In the same combination of the RBW and span, this spectrum analyzer have the “Fast” auto sweep mode, in which the auto sweep time can be set to the same as that of the old types.

However, the level measurement accuracy becomes worse by 1 dB in this mode. So, use this Fast mode in the relative-level measurement such as the adjacent channel leakage power, harmonic distortion, and occupied frequency bandwidth, in which this effect can be neglected.

In the burst-wave relative-level measurement of the adjacent channel leakage power, note that the measurement value may fluctuate by 1 or 2 dB. In that case, compare the value to that in the Hi-Lvl-Acc mode.

## ABOUT THIS MANUAL

### (1) Composition of MS2650/MS2660B/C series spectrum analyzer Operation Manuals

The MS2650/MS2660B/C Spectrum Analyzer operation manuals of the standard type are composed of the following three documents. Use them properly according to the usage purpose.

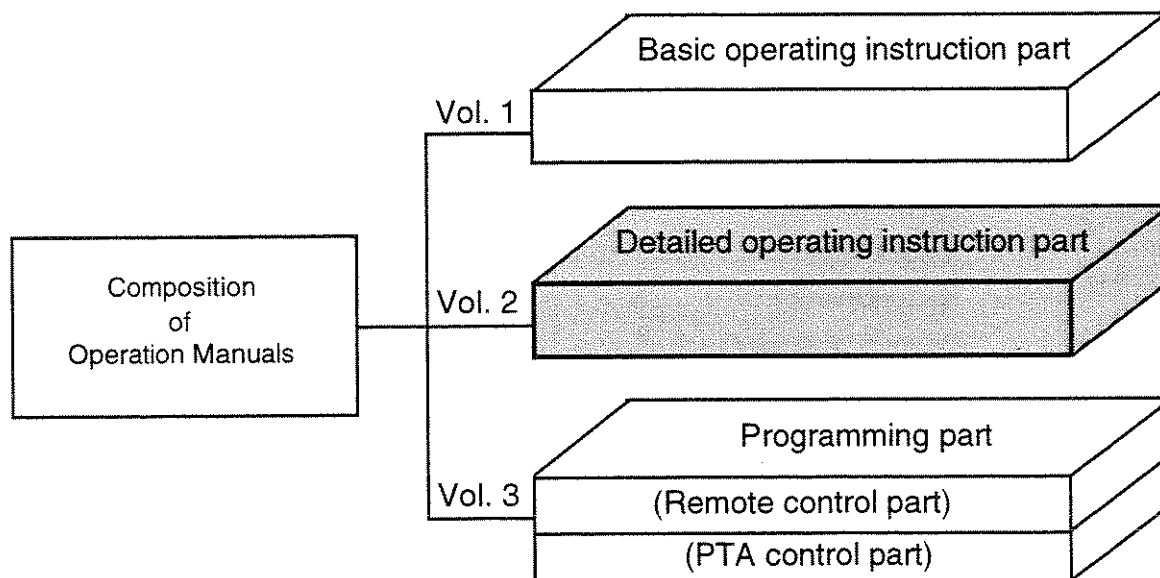

Basic operating instruction part:

Basic Operating Instructions: Provides information on the MS2650/MS2660B/C series outline, preparation before use, panel description, basic operation, soft-key menu and performance tests.

Detailed operating instruction part:

Detailed Operating Instructions: Provides information on the detailed panel operating instructions on the spectrum analyzer that expand on the basic operation and soft-key menu in the Basic Operating Instruction Part.

Programming part:

Composed of the Remote Control Part and PTA Control Part. The Remote Control Part provides information on RS-232C remote control GPIB remote control and sample programs, while the PTA Control Part describes about PTA operation and PTL commands.

# TABLE OF CONTENTS

---

For Safety .....	iii
ABOUT THIS MANUAL .....	I
SECTION 1 BASIC OPERATION PROCEDURE .....	1-1
Signal Display .....	1-3
Marker Operation .....	1-6
"Measure" Function Check .....	1-8
Screen Hard Copy .....	1-9
SECTION 2 FREQUENCY/AMPLITUDE DATA ENTRY .....	2-1
Setting Observation Frequency .....	2-3
Setting Level Range .....	2-8
Offsetting Reference Level .....	2-13
SECTION 3 MARKER FUNCTIONS .....	3-1
Changing Zone Marker Position and Width .....	3-4
Marker Mode .....	3-7
Display Line .....	3-10
Multimarker .....	3-11
Marker Search .....	3-16
Setting Parameters Using Marker Values .....	3-22
SECTION 4 SIGNAL SEARCH FUNCTION .....	4-1
Detecting Peaks .....	4-3
Moving the Measurement Point .....	4-5

SECTION 5	SELECTING THE DISPLAY METHOD .....	5-1
	Display Mode .....	5-3
	Storage Mode .....	5-15
	Detection Mode .....	5-22
	Time Domain .....	5-26
SECTION 6	SELECTING THE SWEEP METHOD .....	6-1
	Sweep Mode .....	6-3
	Trigger Mode .....	6-5
	Zone Sweep and Signal Tracking .....	6-12
	Time Gate Function .....	6-14
	Domain Sweep .....	6-22
SECTION 7	COUPLED FUNCTION .....	7-1
	From Auto to Manual Operation .....	7-4
SECTION 8	AUTOMATIC CALIBRATION AND LEVEL CORRECTION FUNCTIONS .....	8-1
	Automatic Calibration Function CAL .....	8-3
	Preselector tuning .....	8-6
	Measurement System Level Correction .....	8-8
SECTION 9	SYSTEM SETTING AND PRESET FUNCTION .....	9-1
	Coupled Function Common/Independent Setting Mode .....	9-4
SECTION 10	SAVE/RECALL FUNCTION .....	10-1
	Internal Register .....	10-4
	Memory Card File Management .....	10-11
SECTION 11	COPY/SOUND MONITOR/TV IMAGE MONITOR .....	11-1
	Direct Plotting .....	11-3
	Saving Screen Image Data to Memory Card .....	11-9



Displaying a Title .....	11-11
SOUND Monitor .....	11-12
TV Image Monitor .....	11-14
<b>SECTION 12 PTA/DEFINE FUNCTIONS .....</b>	<b>12-1</b>
PTA Program Editing and Loading .....	12-3
User-Definition Function .....	12-6
<b>SECTION 13 MEASUREMENT .....</b>	<b>13-1</b>
Measure Measurement Function .....	13-3
Measurement Examples .....	13-8
<b>SECTION 14 TRACKING GENERATOR .....</b>	<b>14-1</b>
Tracking Generator Menus .....	14-3
Normalize/Instant-Normalize Functions .....	14-4
Transmission Characteristics Measurement .....	14-6
Reflection Characteristics Measurement .....	14-13
Notes on Active Device Measurement .....	14-17
<b>SECTION 15 EMC, Measurement of Field Strength .....</b>	<b>15-1</b>
Menu of EMC .....	15-3
Field Strength Measurement .....	15-4
User Antenna Factor Setting, Save/Load to /from a Memory Card .....	15-7
Caution: When Performing Field Strength Automatic Measurement .....	15-13
EMC Measurement .....	15-15
<b>APPENDIX A SOFT-KEY MENU .....</b>	<b>A-1</b>
Soft-key Menu List .....	A-4
Menu Tree .....	A-6
<b>APPENDIX B KEYWORDS INDEX .....</b>	<b>B-1</b>

SECTION 1  
BASIC OPERATION PROCEDURE

TABLE OF CONTENTS

Signal Display .....	1-3
Turn the power on .....	1-3
Execute automatic calibration .....	1-4
Set the signal to the center of the screen .....	1-4
Enlarge and display the signal .....	1-5
Marker Operation .....	1-6
Check of the zone marker function	
The "marker → CF" function check	
"Measure" Function Check .....	1-8
Screen Hard Copy .....	1-9

# SECTION 1

## BASIC OPERATION PROCEDURE

The basic operation procedure of this equipment is explained here. The operations are listed on the right. Also, the explanation will advance assuming that a 500 MHz signal is applied to the input connector. Please read this manual while operating this equipment.

(  : Panel key,  : Soft key)

<Actual operations>

- (I) Signal display
  - 1) Turn the power on,
  - 2) execute automatic calibration,
  - 3) set the signal to the center of the screen, and
  - 4) enlarge and display the signal.
- (II) Marker operation
 

Check of the zone marker function.  
The "marker → CF" function check.
- (III) "Measure" function check
- (IV) Screen hard copy

## Signal Display

### Turn the power on

Press the standby button on the rear panel, then press the power switch (0) on the front panel. In this case, continue pressing the power switch for one second or more.

Press  Preset key.

Press  Preset All key in the menu.

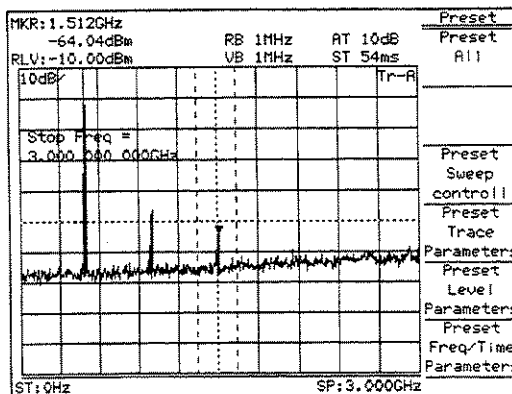

Fig. 1-1

The power is turned on/off only when the power switch is pressed for one second or more. This prevents the power from being turned on/off easily by mistake.

When  panel key (hard key) is pressed, the related soft key menu is displayed.

Partial resettings are enabled. This resetting includes only the display-related resetting or the resetting of special modes such as zone sweep.

## Execute automatic calibration

Wait after switching on the power supply of the machine (warm up period) till the internal temperature becomes stable. This period is approximately 10 minutes.

After warm up, execute automatic calibration.

Press **[Shift]** key then **[0]** key.

Select All Cal from the menu displayed on the display.

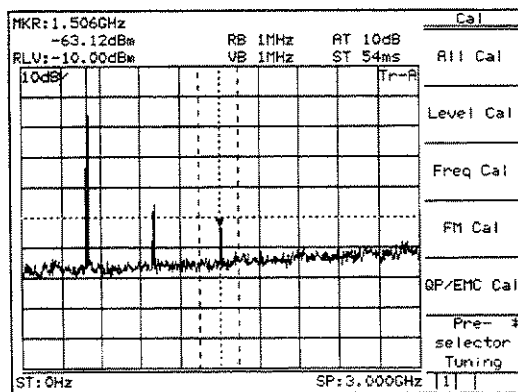

Fig. 1-2

Automatic Calibration is carried out by using an internal source without need for any external cable connection.  
See "Detailed Operation Instructions" for detail information about contents of calibration.

## Set the signal to the center of the screen

Press **[Frequency]** key.

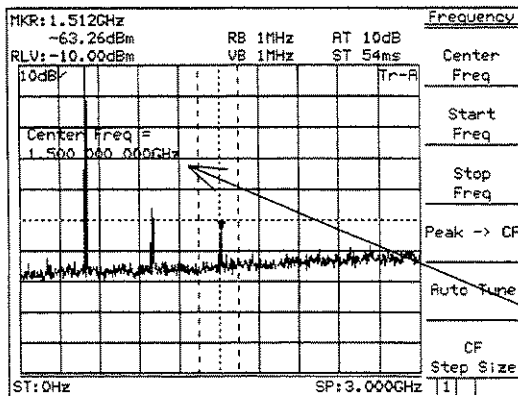

Fig. 1-3

When pressing Frequency, Span, Amplitude or Coupled Function key(s) which is used frequently, Center Frequency, Span, Reference Level, RBW or VBW function is selected and numeric value for the function can be entered into Entry area. This reduces key operation times.

This display section is called Entry area. Selecting the menu displays the current set value of the parameter. The set value can be changed by entering data in Entry area.

Press **Menu On/Off** key

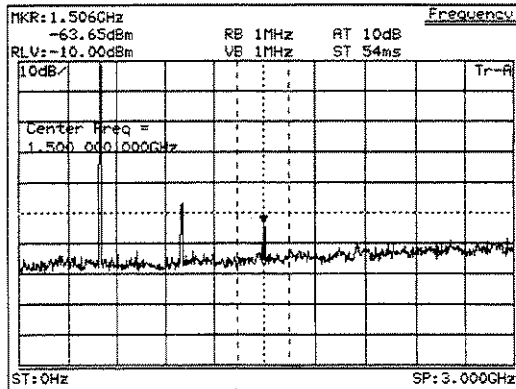

Fig. 1-4

The display of the soft key menu can be switched on/off using **Menu On/Off** key. When the menu disappears, the scale is enlarged. Also, when the menu is displayed, the scale is reduced.

Press **Menu On/Off** key to return to previous screen.

Use the ten-key pad (numeric keys) to enter 500 MHz.

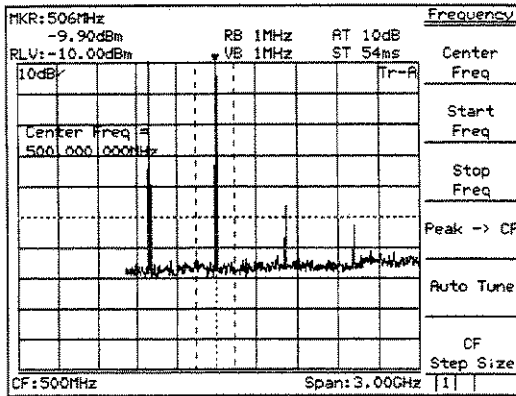

Fig. 1-5

The following three methods to input numeric values to parameters are provided: direct input by the ten-key pad (numeric keys), up/down keys, and rotary knob.

## Enlarge and display the signal

Press **Span** key, then press the **V** down key several times to enlarge the signal display.

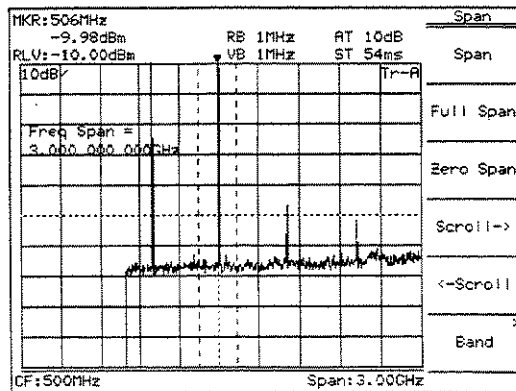

Fig. 1-6

# Marker Operation

Here, checks that the signal frequency and level are displayed in a marker display area. The zone marker automatically fetches the highest level signal within the zone and displays the frequency and level.

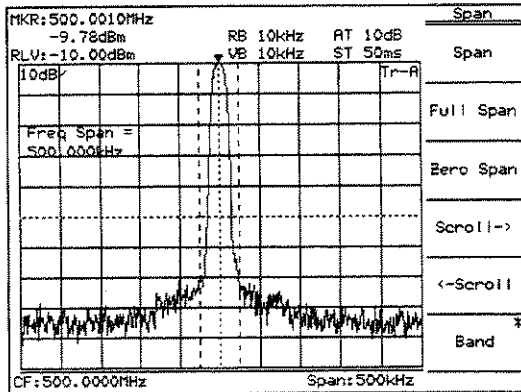

Fig. 1-7

To check Marker → CF function, shift the signal from the center intentionally.

Press **Frequency** key and **More** key in order, and then **Scroll →** key two times.

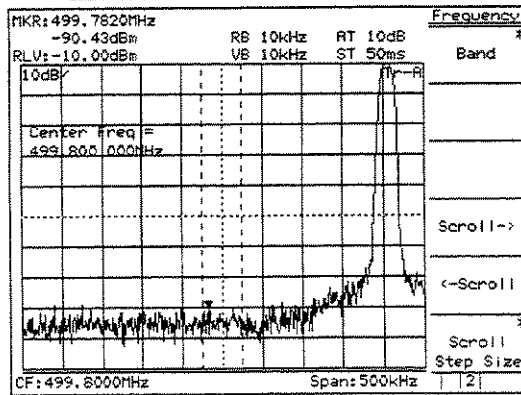

Fig. 1-8

The soft key menu marked by an asterisk on the upper right indicates that the menu can further be opened by pressing the key. Adversely, the soft key menu not marked indicates that the menu cannot be opened any more, so to speak, the end of menu opening.

The following items can easily be checked by the soft key menu tab: How many pages of the soft key menu being displayed currently are there?, and what page is displayed now?

To turn over the page, press **More** key.

Press **Peak Search** key.

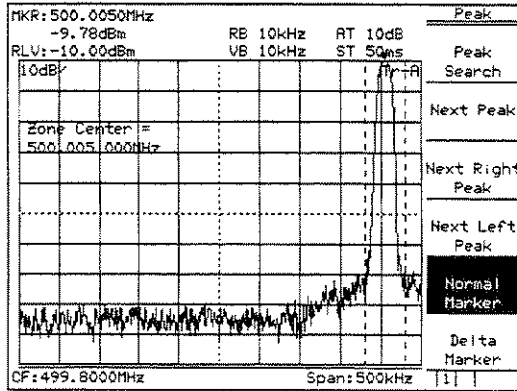

Fig. 1-9

\*Advanced operation memo: It is convenient that the page can also be turned over by repeatedly pressing the panel key. This method is used when key(s), such as **Measure** key, has a number of pages. Besides, the Freq/Ampl and Marker-related keys do not turn over the page by repeatedly pressing the panel key. For these keys, because the first page is important specially, it should always be displayed when the panel key is pressed.

The marker fetches the signal.

Press **More** to open 2nd page, and press **Marker** → key.

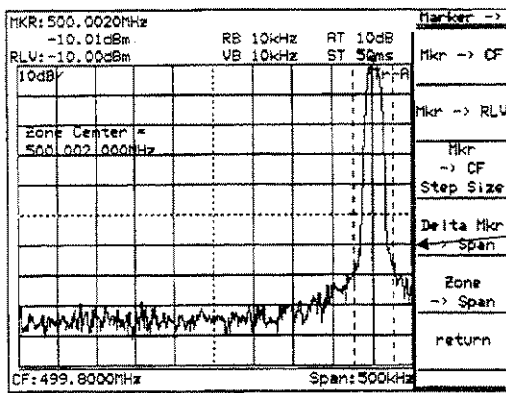

Fig. 1-10

When the soft key menu is pressed, a menu of function related to the menu is further displayed. In this case, as shown in the figure on the left, the thick line (the line on the preceding page) is displayed at the left of the soft key menu. This indicates that a new menu is overlapped with the preceding page.

Press **marker** → CF key.

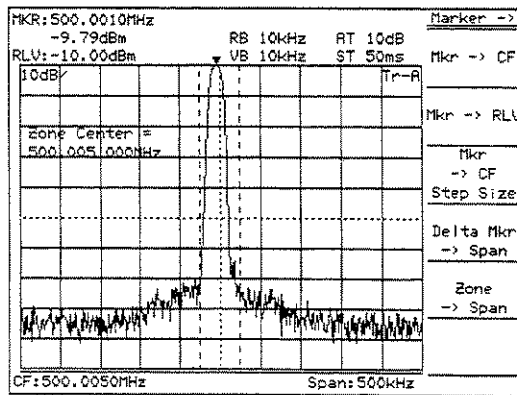

Fig. 1-11

The page opened by pressing the soft key can return to the preceding page by the **Return** key. Besides, it can be checked that which soft key menu was pressed previously to open the current menu, as the menu title is displayed on the upper row of the soft key.

Here, return to the screen of Fig. 1-8 and ensure that the screen changes to that of Fig. 1-11 only by pressing the **→ CF** key.

# "Measure" Function Check

Press **Preset** key and **Preset All** key in order.

Press **Peak Search** key.

If the zero beat signal level (local feed through) is larger than the signal level and the marker fetches the zero beat level, press "Next peak" key and put the marker on the signal.

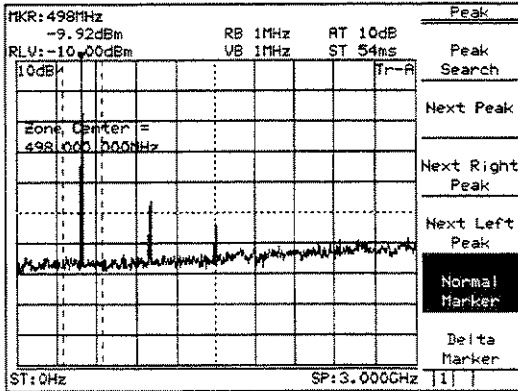

Fig. 1-12

Press the **Measure** key and **Frequency Count** key to set the function of high accuracy frequency measurement of the marker points.

Then, press the **Count On** key and start measurement.

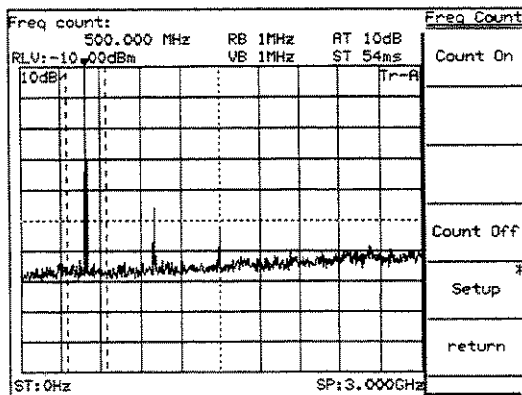

Fig. 1-13

The soft-key menu display can be switched On/Off by the **Menu On/Off** key.

However, keys that condition setting is not possible unless a menu is On unconditionally make the soft-key menu display On when pressing a panel key.

From the screen after executing measurement, press another panel key and change parameters, and then, pressing again the **Measure** key will automatically return to the menu of this screen and not to page 1 of the menu (page learning function).

It is a useful function when repeating measurement.

The frequency of marker points is displayed at the top left of the screen.

Incidentally, the internal counter correctly operates even at the full span condition, so an operation to reduce frequency span otherwise required is not necessary in this model.



## Screen Hard Copy

The screen can be hard-copied with the VP-600 printer (Epson) via an RS232C interface, and the procedures are described below:

- 1) As illustrated below, connect the RS-232C connector and printer with an attached RS-232C cable.
- 2) Press the **Copy** key, and the currently displayed screen is hard-copied.  
If the printed copy is improper, check if the RS-232C interface is correctly set in the following sequence.
- 3) Press the **Shift** key and then the **Interface** key.
- 4) Press the **Connect to Controller** key several times to get None on the display, and press the **Connect to Prt/Plt** key several times and get RS-232C on the display.  
Now the printer can be operated with RS-232C.
- 5) Press the **RS232C Setup** key and set so that (or check if) the setting of RS-232C interface is the same between the main body and printer.  
(For the setting/checking of the RS-232C interface on the printer side, refer to the instruction manual of the printer.)
- 6) Press the **Shift** key and then the **Copy Cont** key.
- 7) Press the **Printer/Plotter** key and select Printer.
- 8) Press the **Printer Setup** key, and then press the **VP-600** key.
- 9) Press the **Magnify** key several times and make the display  $1 \times 1$ .
- 10) Press the **Copy** key, and the currently displayed screen is hard-copied.

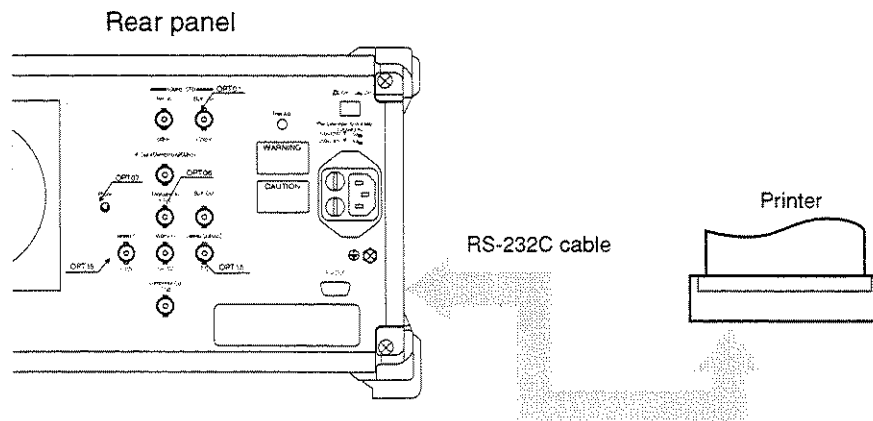

Fig. 1-14

## SECTION 2

### FREQUENCY/AMPLITUDE DATA ENTRY

This section describes the data entry function related to frequency and amplitude in the Freq/Ampl section on the front panel.

#### TABLE OF CONTENTS

Setting Observation Frequency .....	2-3
Center-Span Mode .....	2-4
Start-Stop Mode .....	2-5
Setting Step Size with Step Keys .....	2-6
Setting Frequency Scroll Step Size .....	2-6
Fixing the frequency bands .....	2-7
Setting Full Scan .....	2-8
Setting Zero Span .....	2-8
Setting Level Range .....	2-9
Setting Log/Linear Scale .....	2-10
Selecting Reference Level Units .....	2-11
Setting Reference Level .....	2-12
Setting Reference Level Step Size .....	2-13
Offsetting Reference Level .....	2-14
Setting Attenuator .....	2-16
Preamp Setting .....	2-16
Setting 50 $\Omega$ $\rightarrow$ 75 $\Omega$ Impedance Transformer .....	2-16
Setting Level Frequency Correction Coefficient .....	2-17

## SECTION 2 FREQUENCY/AMPLITUDE DATA ENTRY

### Setting Observation Frequency

The observation frequency of the spectrum analyzer is set in the following two modes:

- Center-Span
- Start-Stop

The frequency setting upper and lower limits are For the MS2651B/2661B/2661C, 0 to 3 GHz  
For the MS2653B/2663B/2663C, 0 to 8.1 GHz, respectively.

The Frequency key is used as the header key for setting the frequency, and the Span key is used as the header key for setting the frequency span.

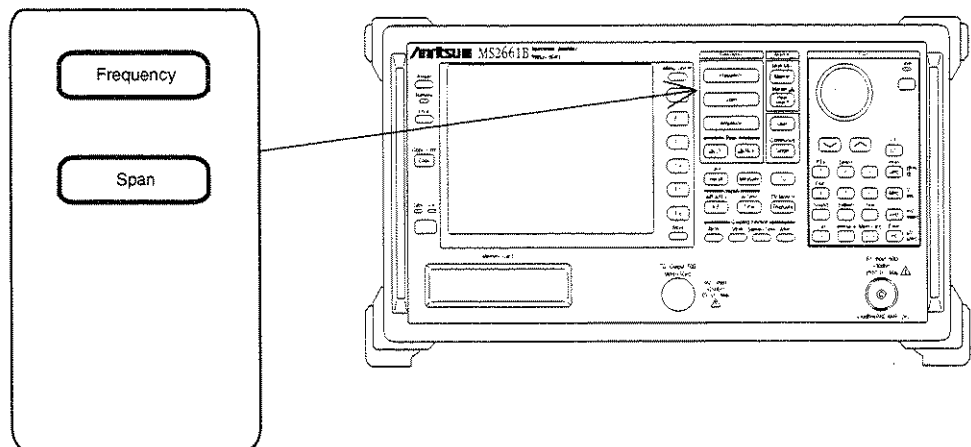

# Center-Span Mode

## (1) Setting center frequency

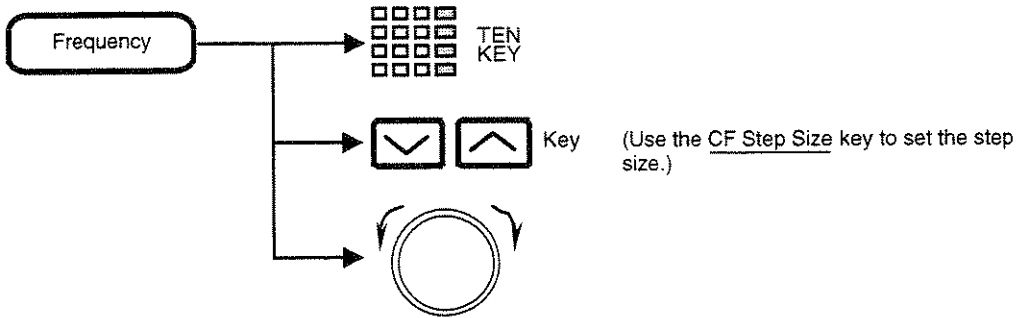

## (2) Setting frequency span

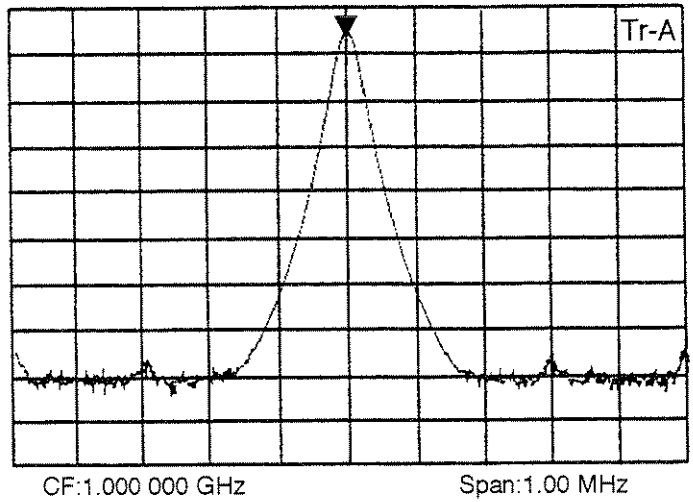
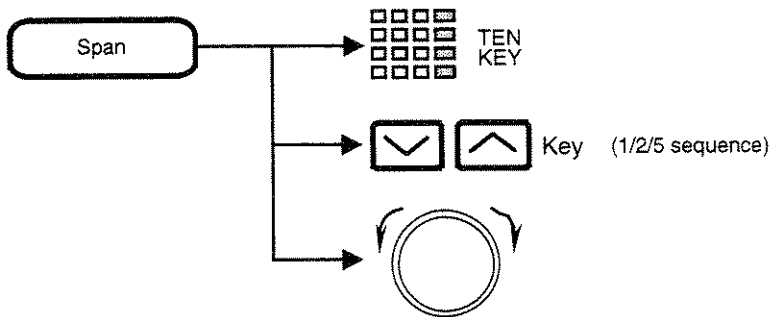

*Note:* When frequency span is 200kHz or less, warming up might be necessary until the observation frequency becomes stable after turning on the power.  
 When "Warm Up" message is being indicated at the top right corner of the indicator, please wait for approximately 3 minutes, and start the measurements after the message disappears.

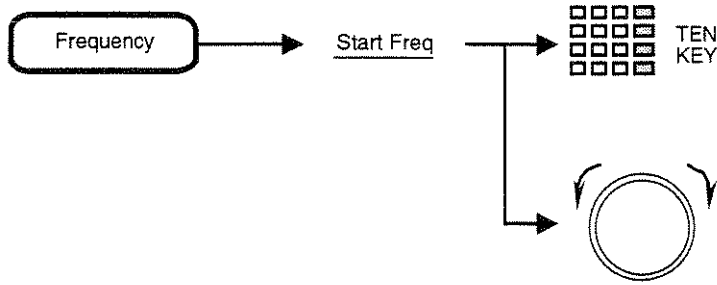

# Start-Stop Mode

(1) Start frequency

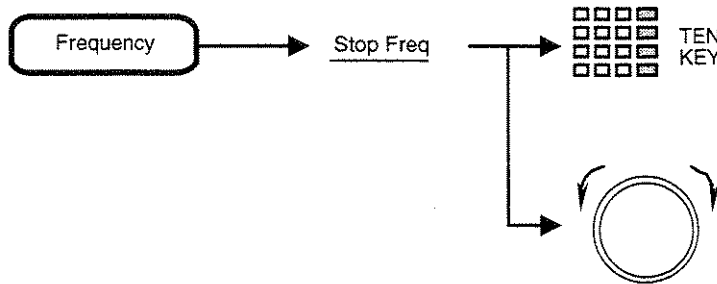

(2) Stop frequency



- Notes:
- Because the  and  keys are the step keys for the center frequency, the start and stop frequencies are also changed.
  - The stop frequency may also vary depending on the values of the frequency span setting resolution and start frequency.

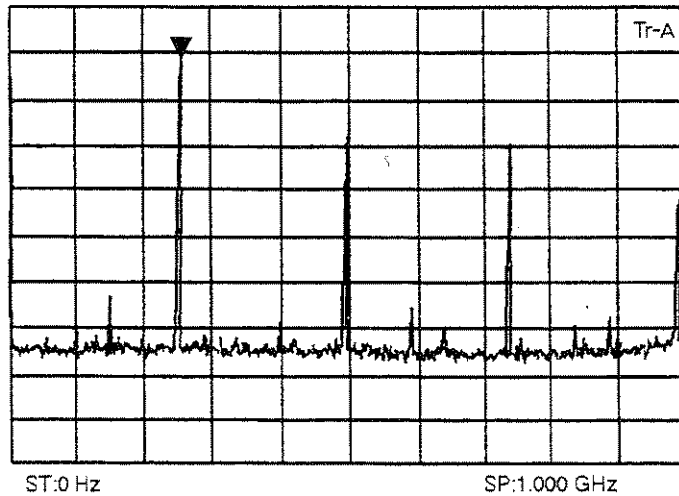

## Setting Step Size with Step Keys

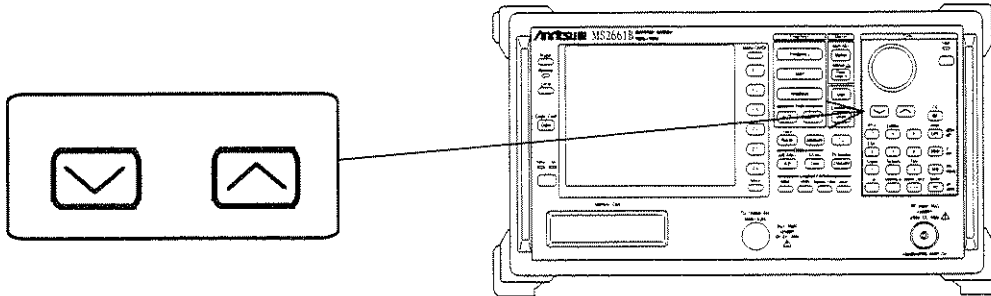

To use the keys to change the step size of the center frequency, register the step size as follows:

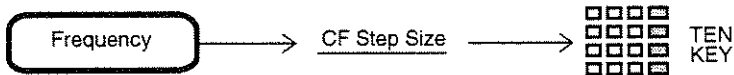

## Setting Frequency Scroll Step Size

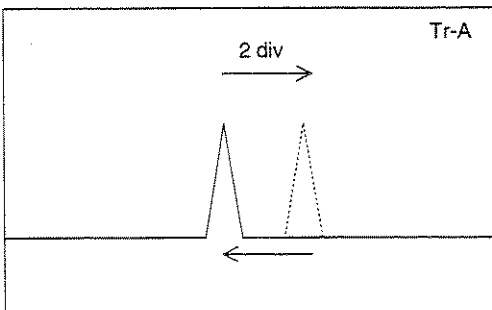
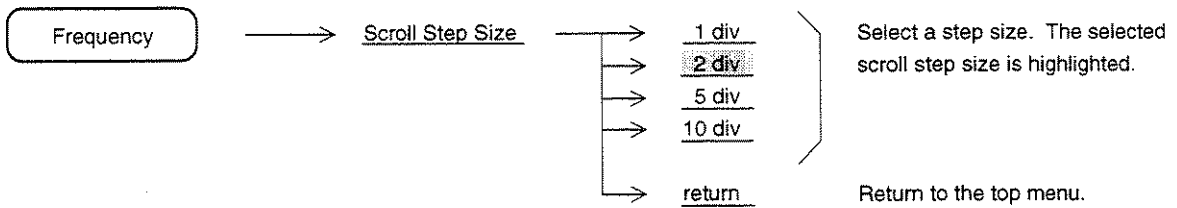

The waveform scrolls 2 divs to the right.



The waveform scrolls 2 divs to the left.

## Fixing the frequency bands

This function is an MS2653B/2663B/2663C dedicated function. It cannot be used in the MS2651B/2661B/2661C.

In the MS2653B/2663B/2663C, the 0 to 8.1 GHz frequency range consists of the following three bands:

- Band 0 ..... 0 to 3.2 GHz
- Band 1<sup>-</sup> ..... 2.92 to 6.5 GHz
- Band 1<sup>+</sup> ..... 6.4 to 8.1 GHz

In the initial state, the Auto Band mode that is operated by selecting the optional frequency band is selected according to the range of frequencies to be observed.

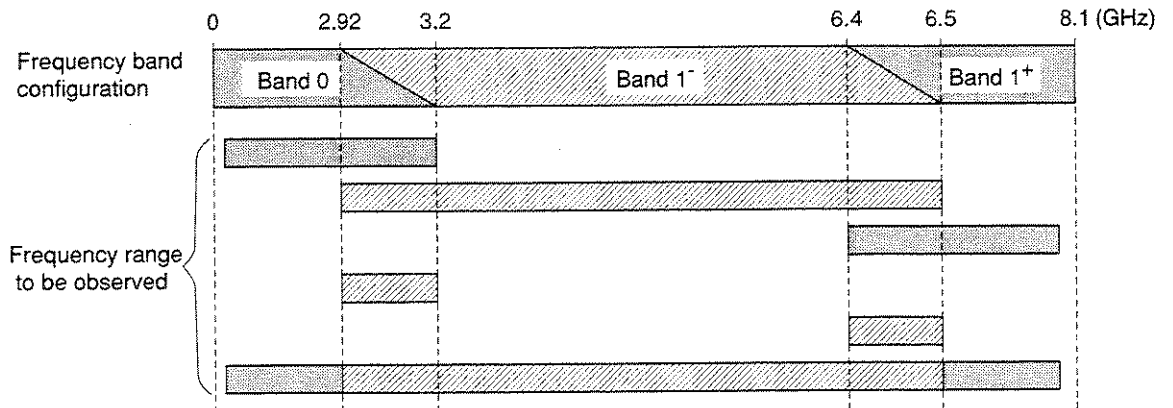

Selection of frequency bands according to range of frequencies to be observed in Auto Band mode

Perform the following to set the frequency bands, for example, when the frequency bands are switched:

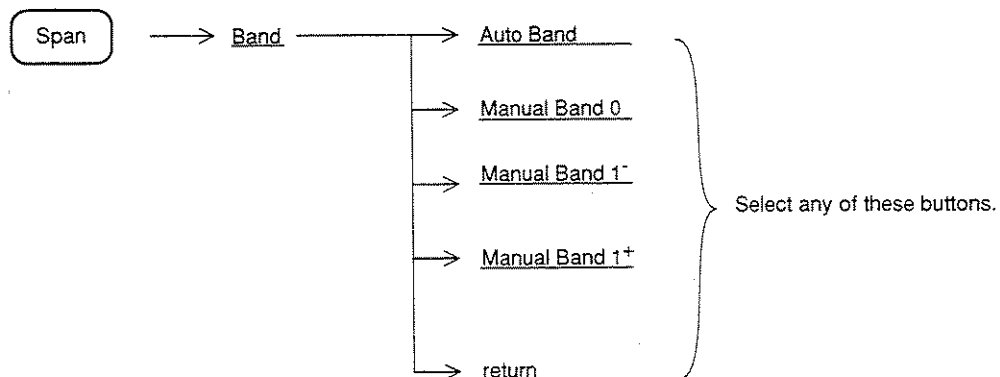

## Setting Full Span

In the normal operating state, pressing Preset the key allows the entire frequency range of the spectrum analyzer to be swept over the full span. However, this setting also initializes the parameters except the frequency range.

To set the full span and leave the other parameters unchanged, perform the following key operations.



For the MS2651B/2661B/2661C, 0 to 3 GHz

For the MS2653B/2663B/2663C Auto band, 0 to 8.1 GHz

For Band 0, 0 to 3.2 GHz

For Band 1-, 2.92 to 6.5 GHz

For Band 1+, 6.4 to 8.1 GHz

## Setting Zero Span

The Spectrum Analyzer can operate as a selective level meter in which the horizontal axis is graduated as a time axis by setting the frequency span to 0 Hz. The rising and falling edges of burst waves can also be observed and measured.

Performing any of the following key operations allows the spectrum analyzer to operate in the zero panel (time domain) mode.

- Span → 0 → Hz
- Span → Zero Span
- Time

For further details on the zero span (time domain) mode, see SECTION 5, "SELECTING THE DISPLAY METHOD."

In the frequency and time domains, the RBW, VBW, Sweep time and other coupling functions time can be set to different values. For further details, see CHAPTER 9, "SYSTEM SETTING AND PRESET FUNCTION."



## Setting Level Range

The table below shows the types of level display modes and the ranges of the reference level (top graticule of the amplitude scale) for the different modes. When a preamp (Option) is used, the entire reference level range is shifted 20 dB.

		50 $\Omega$ (standard)	75 $\Omega$ (with Opt.22) MS2651B/2661B/2661C only
Display mode	Units	Reference Level range	
Log scale	dBm	-100 to +30 dBm	-100 to +25 dBm
	dB $\mu$ V	+7 to +137 dB $\mu$ V	+8.8 to +133.8 dB $\mu$ V
	dBmV	-53 to 77 dBmV	-51.2 to 73.8 dBmV
	V	2.24 $\mu$ V to 7.07 V	2.74 $\mu$ V to 4.87 V
	dB $\mu$ V (emf)	+13 to +143 dB $\mu$ V	+14.8 to +139.8 dB $\mu$ V
	W	100 fW to 1.0 W	100 fW to 316 mW
	dB $\mu$ V/m	-----	-----
Linear scale	V	224 $\mu$ V to 7.07 V	274 $\mu$ V to 4.87 V

dBm: dBm unit system where 1 mW/50  $\Omega$  or 75  $\Omega$  is defined as 0 dBm.

dB $\mu$ V: dB $\mu$ V unit system where 1 $\mu$ V is defined as 0 dB $\mu$ V, and the terminal voltage display is terminated into 50  $\Omega$  or 75  $\Omega$ .

dBmV: dBmV unit system where 1 mV is defined as 0 dBmV, and the terminal voltage display is terminated into 50  $\Omega$  or 75  $\Omega$ .

dB $\mu$ V (emf): dB $\mu$ V (emf) unit system based on the open-voltage display, and dB $\mu$ V +6 dB is fed as the output value.

The Amplitude key is used as the header key for setting the amplitude level.

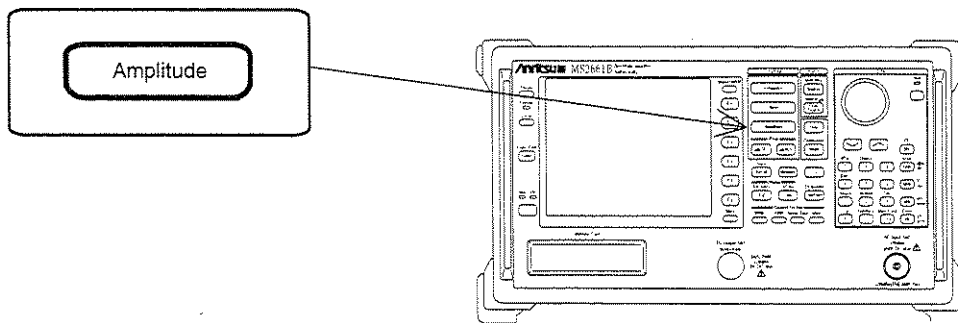

## Setting Log/Linear Scale

To set the amplitude scale to log scale or linear scale, perform the following key operations.

### (1) Setting log scale

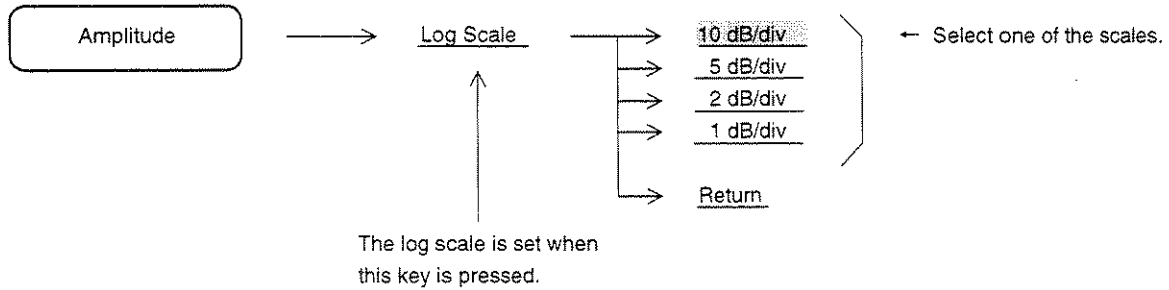

### (2) Setting linear scale

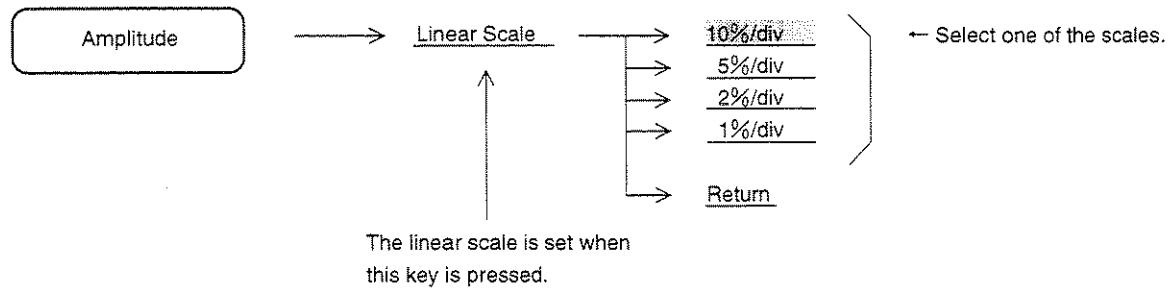

The reference level remains constant, independent of switching between log and linear scales.

When the reference level is set to less than  $-60$  dBm in the log scale mode, the reference level of the linear scale is switched to  $224 \mu\text{V}/50 \Omega$  or  $274 \mu\text{V}/75 \Omega$ .

## Selecting Reference Level Units

In the log scale mode, the spectrum analyzer provides six types of reference level units: dBm, dB $\mu$ V, dBmV, V, dB $\mu$ V (emf), dB $\mu$ V/m, and W. To select one of the reference level units, perform the following key operations.

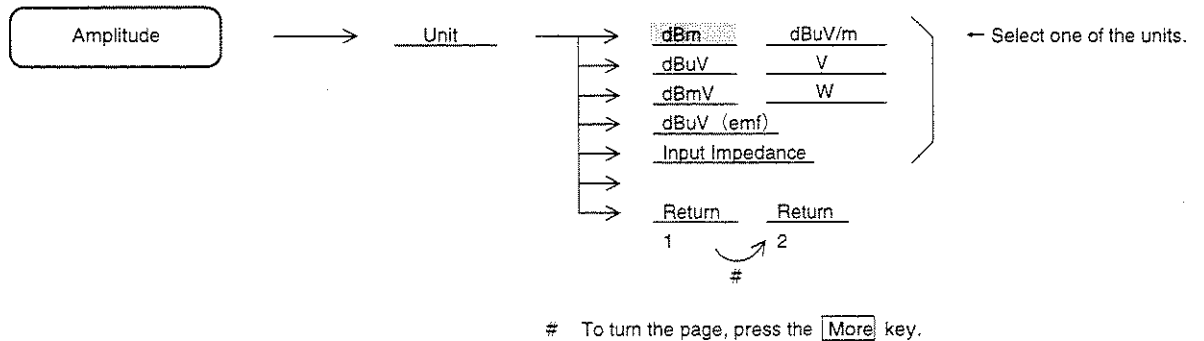

Because the reference level unit used for the linear scale is only V, there is nothing to select.

## Selecting Input Impedance

This function is an standard: 50  $\Omega$  model dedicated function.

The input impedance of the spectrum analyzer is 50 $\Omega$ . Measurement with 75 $\Omega$  can be enabled by using 50 $\Omega$ →75 $\Omega$  Impedance Transformer. In this case, measured value is level converted.

When the input impedance is set to 75 $\Omega$  as shown in the figure below; measured value is level converted, and displayed according to the level unit of the dB $\mu$ V/dBmV/dB $\mu$ V(emf)/V.

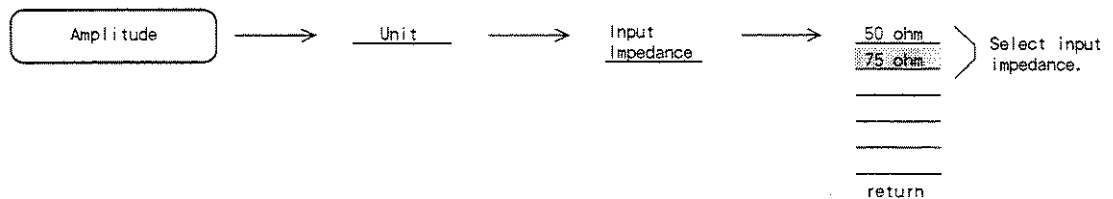

When the input impedance is set to 75 $\Omega$ , the level is displayed after adding +1.8 dB to the 50 $\Omega$  level, and "75 ohm" is displayed at the top right of the waveform.

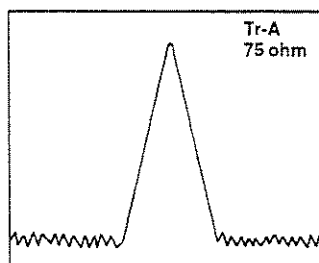

When the MA1621A is used as the 50Ω→75Ω Impedance Transformer, the insertion-loss frequency characteristics of the MA1621A must be compensated. The spectrum analyzer has the level-compensation function. (see p.2-16 "Setting 50 Ω→75 Ω Impedance Transformer (MA1621A)".)

## Setting Reference Level

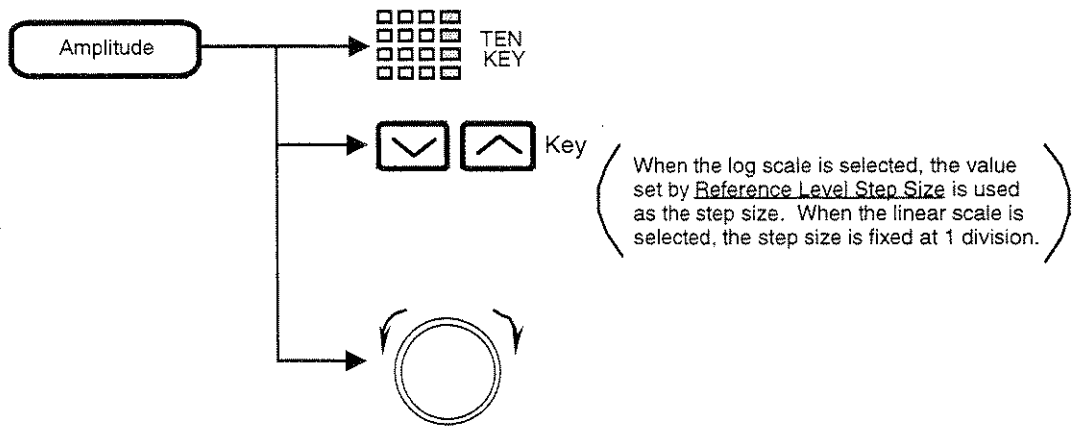

Select the reference level (top graticule of the amplitude scale) by performing the following key operations.

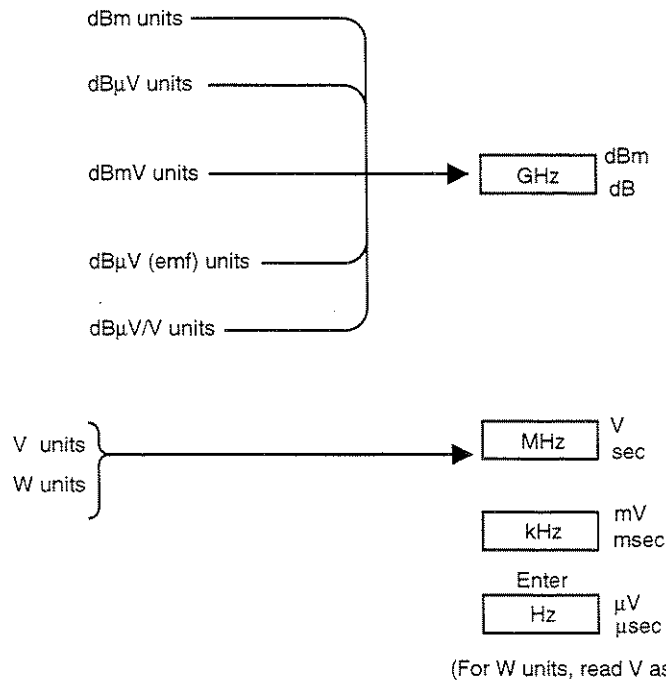

Use the unit key as follows, according to the set reference level unit.



## Setting Reference Level Step Size

To change the reference level with the   keys, set the step size by performing the following key operations.

### (1) Log scale

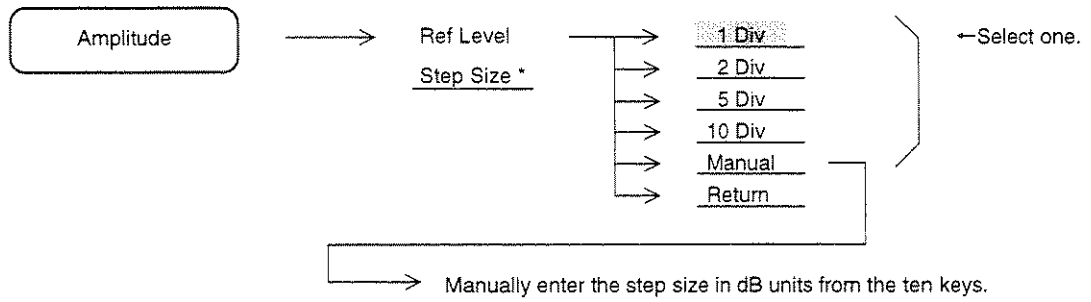

### (2) Linear scale

Fixed at 1 division.

# Offsetting Reference Level

The reference level and waveform trace can be displayed by adding a given offset.

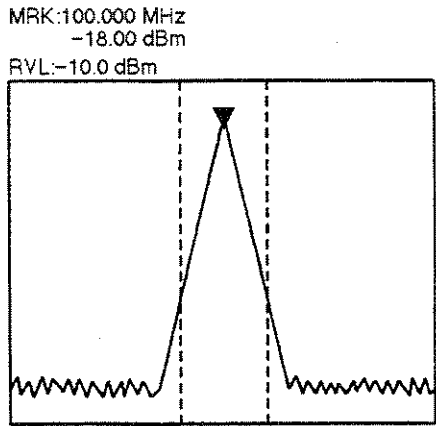

When the offset  
value is set to 30 dB.



When the offset  
value is set to -20 dB.

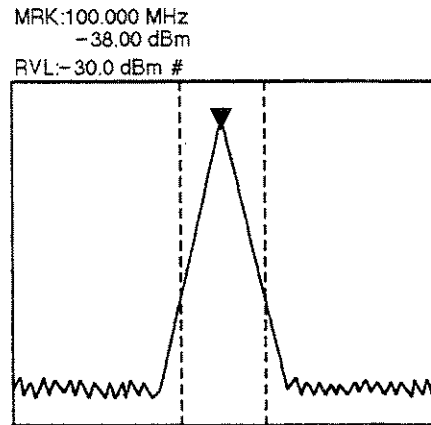
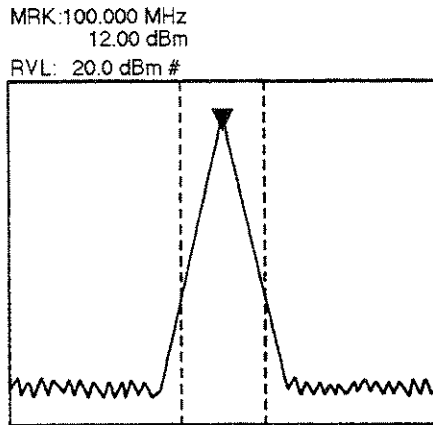

The # is displayed to the right of the reference level display above the scale.

Turn the offset display On/Off and set its offset value by performing the following key operations.

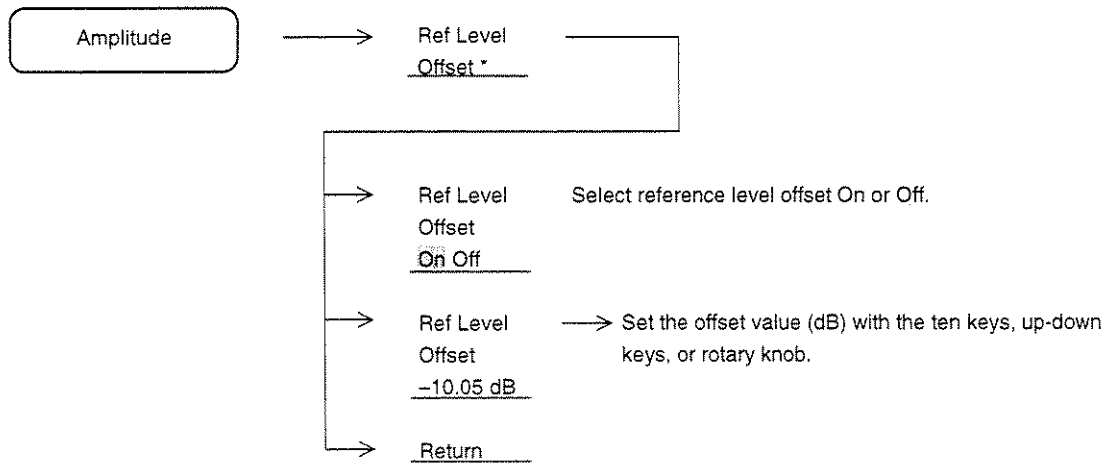

The offset value setting range is from  $-100$  to  $+100$  dB. The offset value resolution is  $0.01$  dB.

The offset can be applied to each trace (A, B, BG, Time), but it cannot be applied when monitoring FM demodulated waveforms and when using A-B→A function.

## Setting Attenuator

Press the **Amplitude** key, then press the **Attenuator key**.

Select manual setting or automatic setting.

For manual setting, enter the attenuator setting in dB units from the ten keys.

## Preamp Setting

This function is an MS2651B/2661B/2661C dedicated function.

Press the **Amplitude** key, then press the **Pre Ampl** key.

Press the **Pre Ampl On/Off** key. The 20 dB preamp (Option) is turned On and Off. The preamp gain-frequency curve is also compensated.

## Setting 50 $\Omega$ $\rightarrow$ 75 $\Omega$ Impedance Transformer

This function is an standard: 50  $\Omega$  model dedicated function.

When the optional MA1621A (75  $\Omega$  $\rightarrow$ 50  $\Omega$ ) impedance transformer is installed to the RF input attenuator (see the figure below), set the input impedance to 75  $\Omega$ .

Press the **Amplitude** key, then press the **Input Transformer** key.

Set the MA1621A to On with the On Off key.

When the input impedance is set to **On**, it is assumed that a 25  $\Omega$  resistor is connected in series with the input, the level is converted for 75  $\Omega$ , the insertion-loss frequency characteristic is corrected, and then the measured result is displayed.

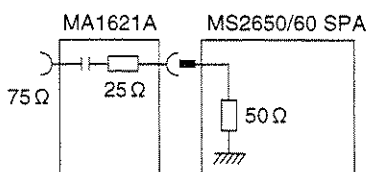



## Setting Level Frequency Correction Coefficient

This function corrects the level-frequency characteristics of the cables and pads (connected to the front end of the RF Input connector) so that the level becomes flat. Correction tables are written via the RS-232C or GPIB interface.

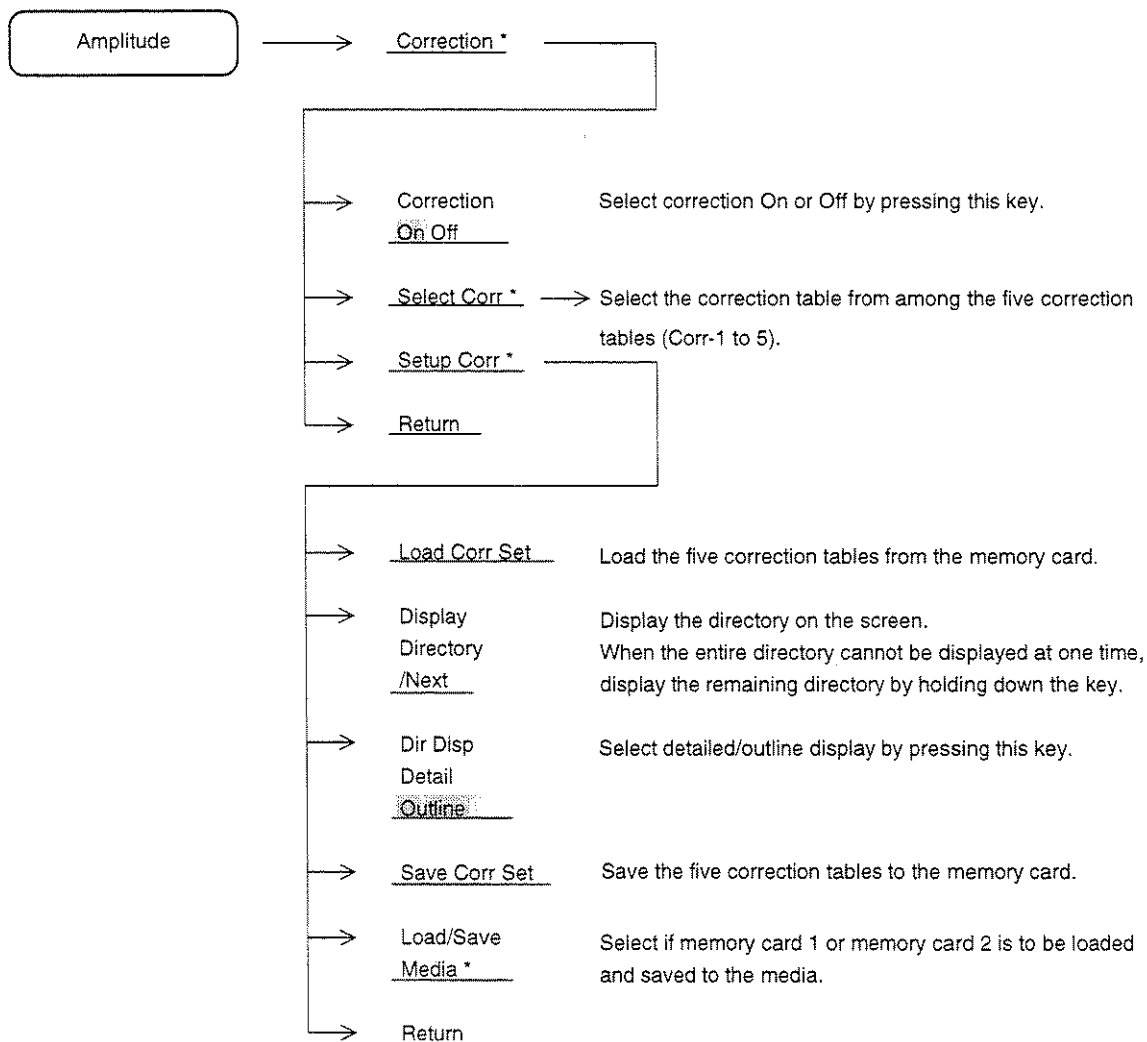

For further details, see SECTION 8.

## SECTION 3

### MARKER FUNCTIONS

This section describes the marker functions for improving the measurement efficiency, such as the zone marker, marker mode menu, marker search, and the parameters set by marker value.

For a description of marker tracking and zone sweep setting, see SECTION 6 SELECTING THE SWEEP METHOD.

### TABLE OF CONTENTS

Changing Zone Marker Position and Width .....	3-4
Changing Zone Marker Width .....	3-4
Changing Zone Marker Position .....	3-6
Marker Mode .....	3-7
Normal Marker .....	3-7
Delta Marker .....	3-8
Marker Off .....	3-9
Switching Marker Search Mode .....	3-9
Display Line .....	3-10
Setting Display Line .....	3-10
Multimarker .....	3-11
Highest 10 Multimarker .....	3-11
Harmonics Multimarker .....	3-12
Marker List .....	3-12
Manual Set .....	3-13
Multimarker Off .....	3-14
Marker Search .....	3-15
Peak Search .....	3-15
Next Peak Search .....	3-16
Next Right Peak Search/Next Left Peak Search .....	3-17
Dip Search .....	3-18

Next Dip Search .....	3-19
Setting Search Resolution .....	3-19
Setting Search Threshold .....	3-20
Setting Parameters Using Marker Values .....	3-21
Mkr → CF/Mkr → RLV .....	3-22
Mkr → CF Step Size .....	3-23
Delta Mkr → Span .....	3-24
Zone → Span .....	3-25

# SECTION 3 MARKER FUNCTIONS

The keys inner section are used as the header keys for setting the marker functions.

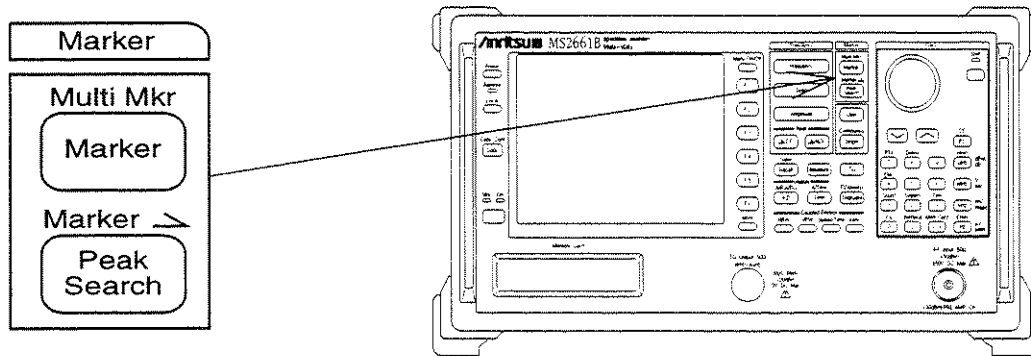

## Changing Zone Marker Position and Width

The part enclosed in dotted lines in the center of the screen shown in the figure below is called the zone marker. The current marker within this zone marker normally moves to the maximum level. The frequency (or time for time domain mode) and level at the current marker point (intensified point) are displayed at the top left-hand corner of the screen.

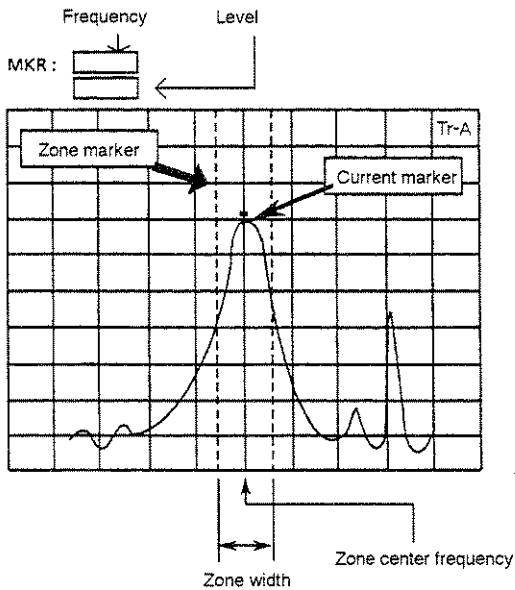

## Changing Zone Marker Width

The zone marker width is initially set to 1 division, but can be changed from 1 point to 10 divisions by performing the following key operations.



The zone marker width can be arbitrarily set from 1 point to 10 divisions by rotary knob.

The zone marker width can be arbitrarily set from 1 point to 10 divisions by the corresponding frequency input from the ten keys.

When the zone marker width is set to 1 point (Spot), the zone marker becomes a vertical line. This is called a spot marker. Since the marker center frequency and the current marker frequency coincide, the level at the desired frequency can be measured.

Example of Spot Marker (Zone Width: 1 Point)

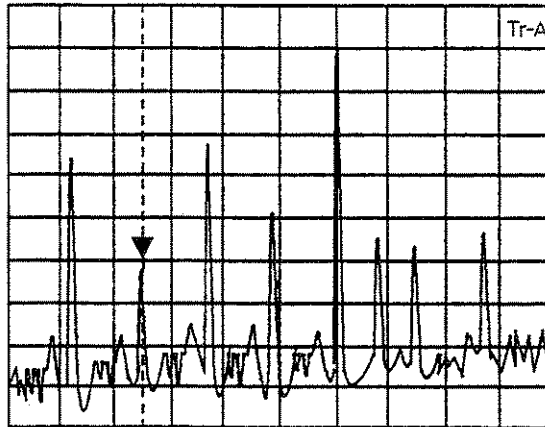

If the zone marker is set to 10 divisions when the zone center frequency is at the center of the frequency axis on the screen, the current marker will always move to the maximum peak level over the entire range of the observation frequency.

Example of Zone Width: 10 Divisions

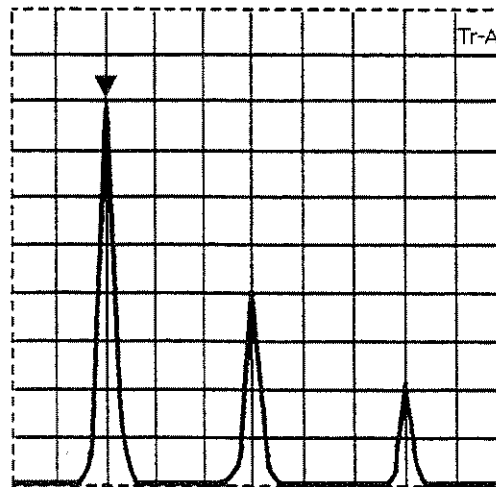

Since the zone width in the time domain mode always becomes 1 (Spot), it cannot be changed.

## Changing Zone Marker Position

The center frequency (time) of the zone marker is initially centered on the frequency (time) axis on the screen. By performing the following key operations, the zone marker can be moved from the left end to the right end of the frequency axis (time) on the screen.

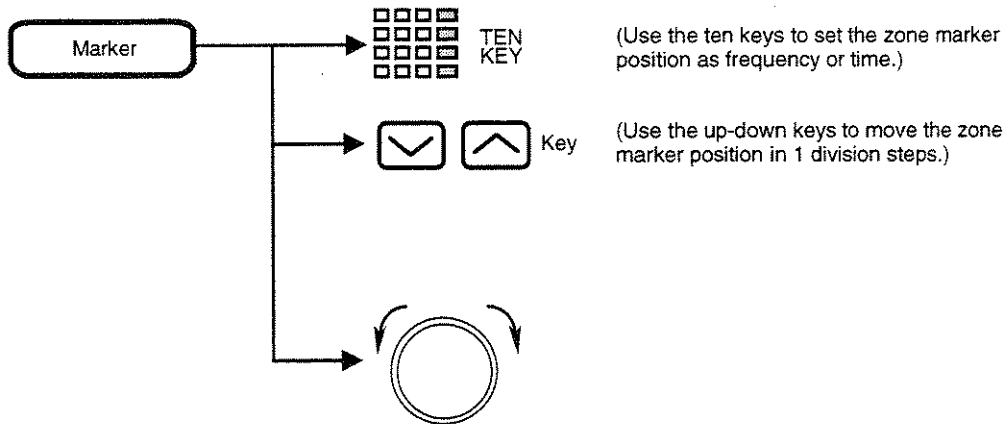

In the delta marker mode, setting the zone marker center frequency (time) with the ten keys results in entry of the delta marker value (difference between reference marker and current marker).

## Marker Mode

Three types of markers can be used with the spectrum analyzer: normal marker, delta marker, and multimarker.

### Normal Marker

A single marker is indicated by ▼ at the maximum level within the zone marker. The frequency and level at that point are displayed digitally.

The normal marker is initially set to ON. When the current state is another marker mode, or when the normal marker is set to OFF, perform the following key operations to set the normal marker to ON.

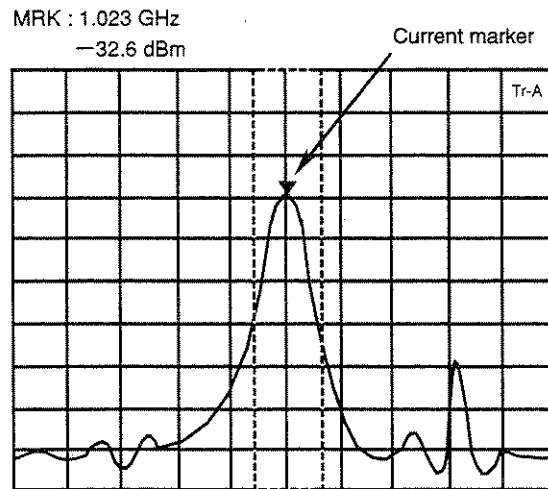
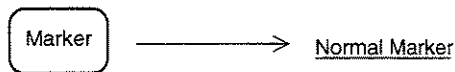

The normal marker displays the absolute level. By setting a display line, the normal marker can also display the level relative to a given level specified as a reference line.



## Delta Marker

The current marker position when the delta marker is set to On is fixed as the reference marker (reference point). Then, as the current marker is moved, the reference marker and current marker frequency (time) and level differences are displayed digitally as delta marker values.

In the delta marker mode, the reference marker is indicated by  $\square$ .

To set the delta marker to On, perform the following key operations.

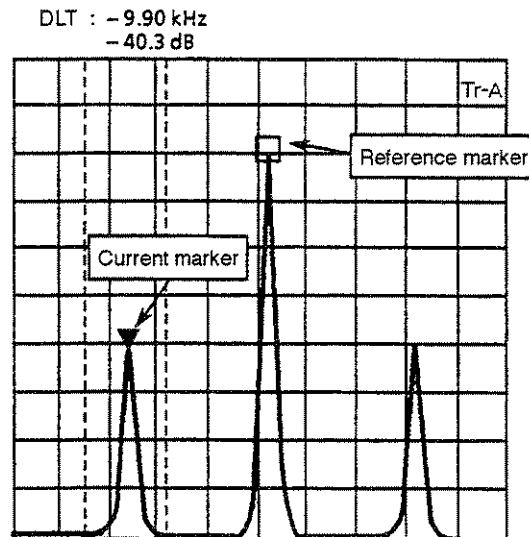

Press the Delta Marker key in the delta marker mode. The reference marker moves to the current marker position and switches to the delta marker mode with that point as the reference point.

Varying the spectrum waveform in the delta marker mode does not change the marker frequency level. The reference marker is not necessarily always on the waveform because it remains unchanged. Also, when the reference marker cannot be positioned on the screen by changing the observation frequency and level and range, it is at the edge of the scale lines.

The marker mode at delta marker-ON becomes the normal mode when the scale mode is changed from log scale to linear scale and vice-versa. If the scale mode was changed, set the delta marker again.

## Marker Off

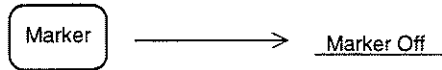

The marker disappears from the screen. When the Normal Marker key is pressed, the marker is displayed.

## Switching Marker Search Mode

Searching the maximum value (Peak) or minimum value (Dip) in the zone marker is selected by pressing this key. Usually select Peak.

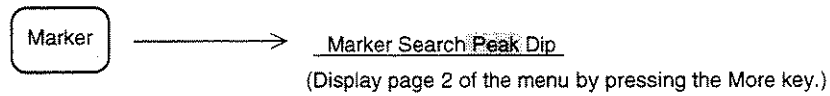

## Display Line

In the state in which a horizontal line which indicates a given level (frequency deviation for FM demodulated waveform display) is displayed on the scale, the display line can be used as the frequency response measurement guideline, or as the reference line of the marker level measurement or pass/fail judgement with a standard line.

## Setting Display Line

To turn the display-line On and Off and to set the display-line level (frequency deviation), perform the following key operations.

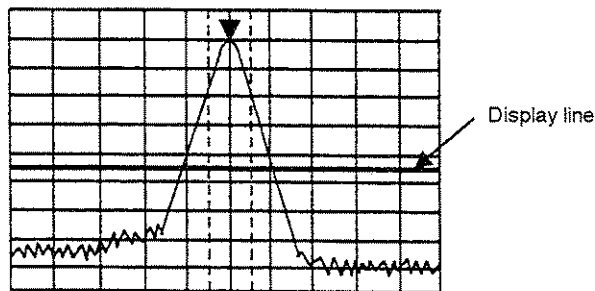
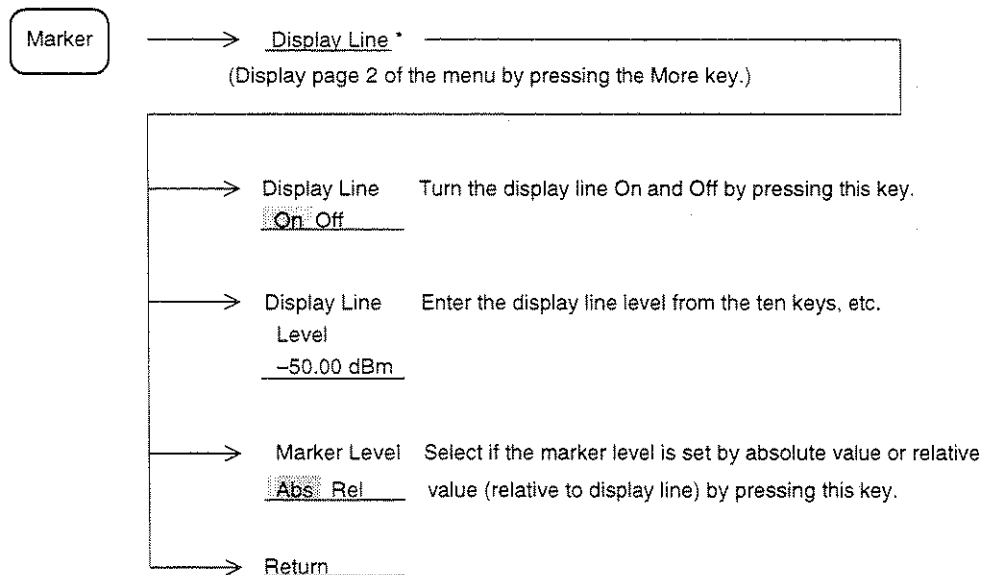

Display-line On and Off are common to all traces (A, B, BG, Time). Also, the display-line level is common except for FM demodulated waveform display.

The display-line level and Abs/Rel can be selected independently for each trace.

## Multimarker

The spectrum analyzer has a marker function which displays up to ten markers displayed simultaneously. Multimarker can be set by the following four methods:

- Highest 10
- Harmonics
- Marker List
- Manual Set

### Highest 10 Multimarker

Allocates up to 10 multimarkers in descending order of signal peak level displayed on the screen.

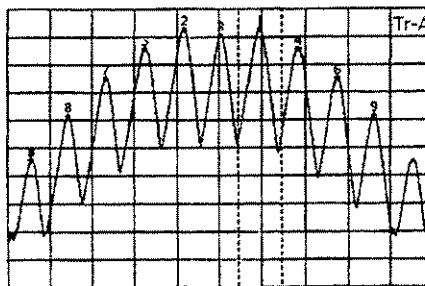

After executing Highest 10, an active marker (with the same functions as the current marker) moves to the peak point of the maximum level signal.

**Note:** Each multimarker has a zone as the same as the current marker, and is positioned at the maximum level point. So, when the next sweep is done after Highest 10 operation, each multimarker position may be changed. To protect this, execute the Highest 10 after stopping the sweeping or after narrowing the zone width.

## Harmonics Multimarker

Allocates multimarkers to the 2nd to the 10th harmonic signals of the active marker signal as the fundamental signal.

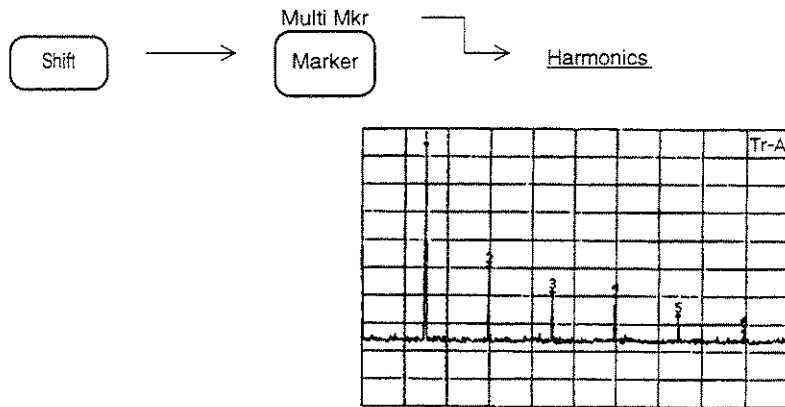

**Note:** If the fundamental and second harmonic signals are not separated by more than the marker zone width, or when there are larger level signals other than harmonic signals in the frequency range of the marker zone width centered at the harmonic signals, harmonic signals will be incorrectly detected. In this case, narrow the marker zone width.

## Marker List

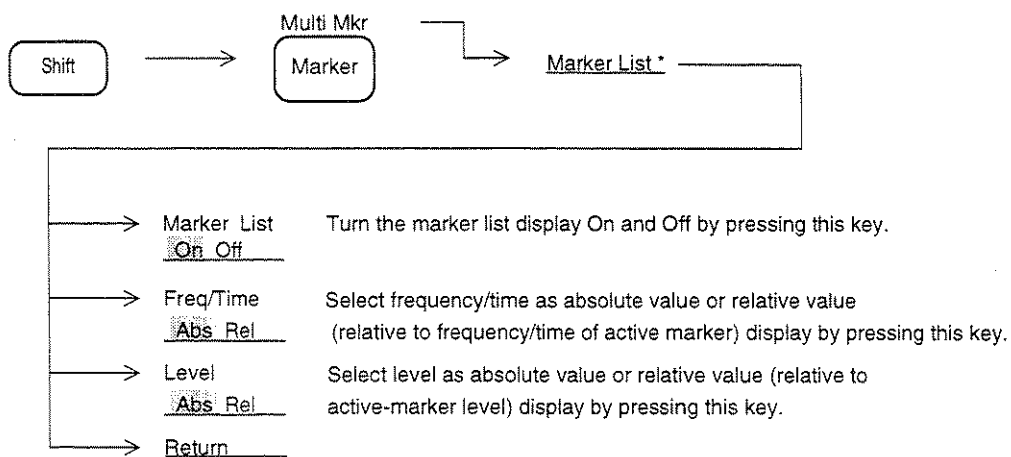

In Freq/Time Rel mode, frequency and time of the markers except active marker are displayed in relative values, and "R" marks are appended at the left.

In Level Rel mode, level of the markers except active marker are displayed in relative values,

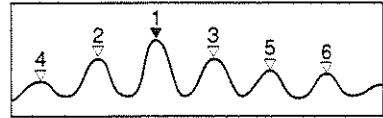

Marker List	
* 1:	1.00000GHz -15.12dBm
2:P	-1.31MHz -3.55dB
3:P	1.41MHz -3.61dB
4:P	-2.00MHz -5.96dB
5:P	1.89MHz -6.21dB
6:P	2.20MHz -6.76dB
7:	
8:	
9:	
10:	

## Manual Set

Allocates up to 10 multimarkers to arbitrary frequencies or time points.

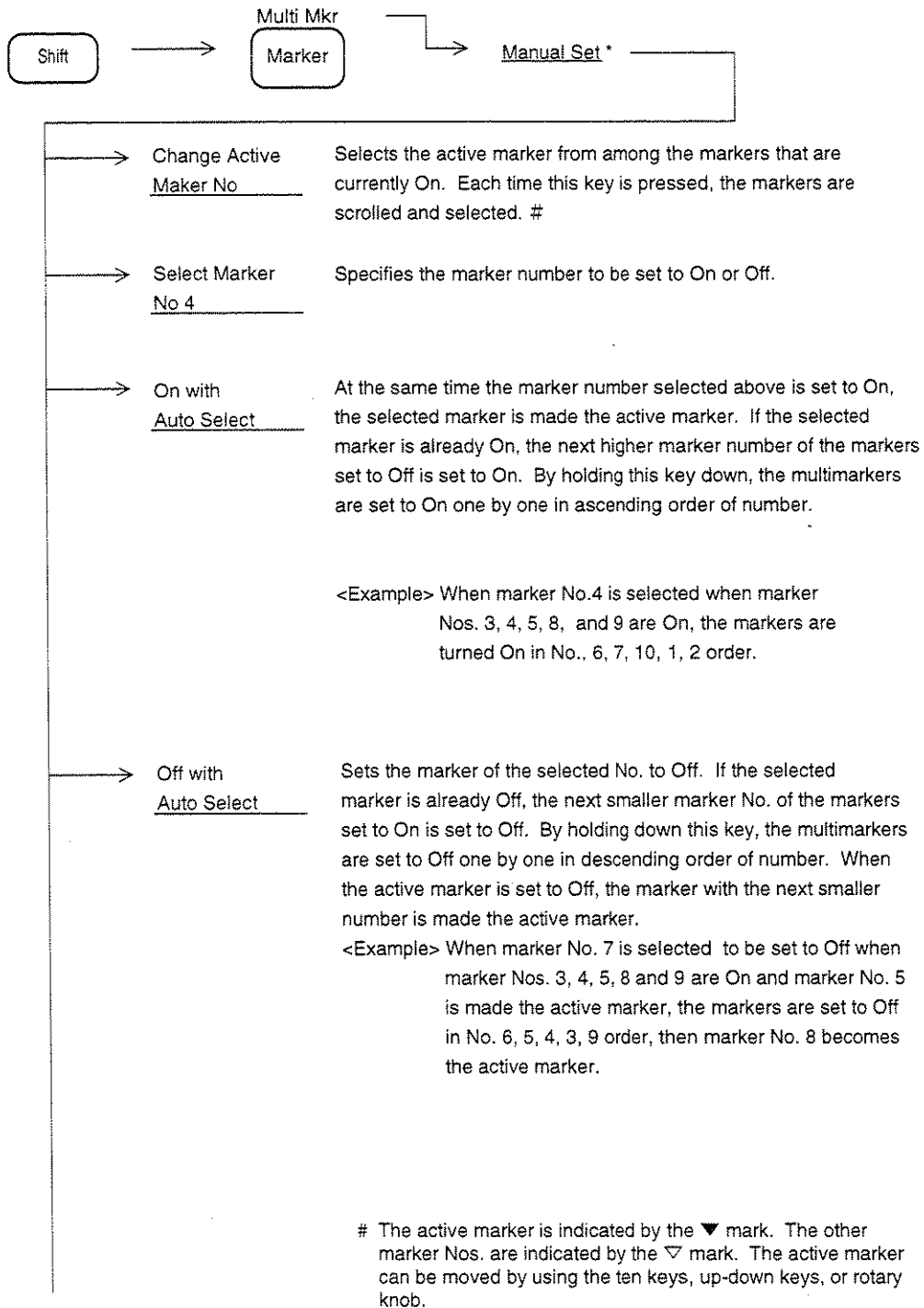

Continued

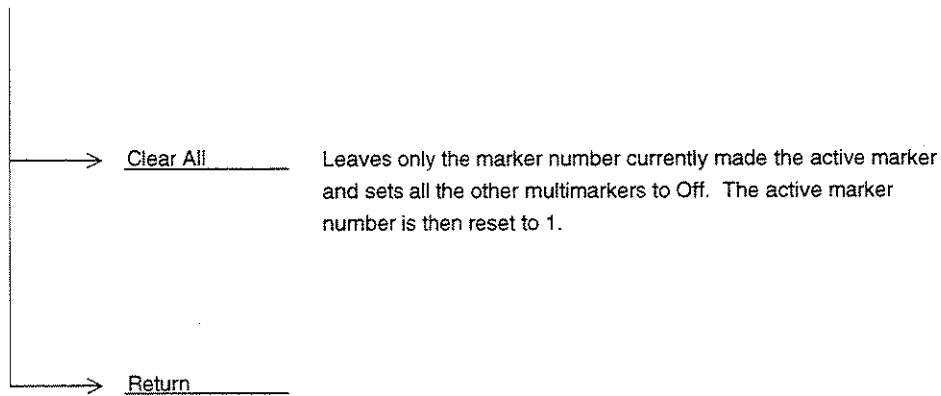

Displays the active marker value.

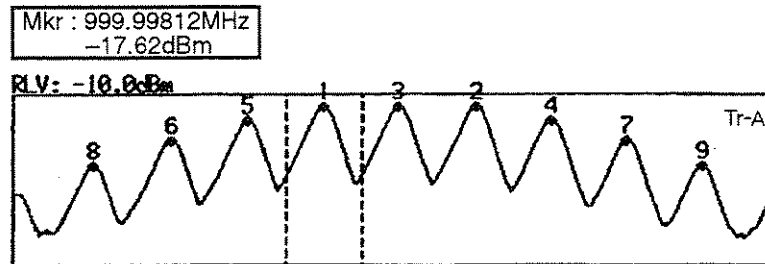

\* indicates the active marker.

MARKER LIST		
* 1:	999.998 12MHz	-17.62dBm
2:	1.000 002 12GHz	-17.62dBm
3:	1.000 000 00GHz	-17.89dBm
4:	1.000 004 00GHz	-25.88dBm
5:	999.996 00MHz	-25.89dBm
6:	999.994 00MHz	-37.53dBm
7:	1.000 006 04GHz	-37.53dBm
8:	999.992 00MHz	-52.45dBm
9:	1.000 008 04GHz	-52.49dBm
10:		

Undisplayed markers are set to Off.

## Multimarker Off

To return from multimarker to normal marker, perform the following key operations.

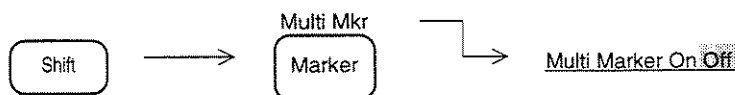



## Marker Search

The spectrum analyzer has the following six marker search functions:

- Peak search
- Next Peak search
- Next Right Peak search
- Next Left Peak search
- Dip search
- Next Dip search

## Peak Search

Peak Search detects the maximum level point from the entire trace in which a marker is displayed and moves the marker to that point.

To Execute Peak search, perform the following key operations.

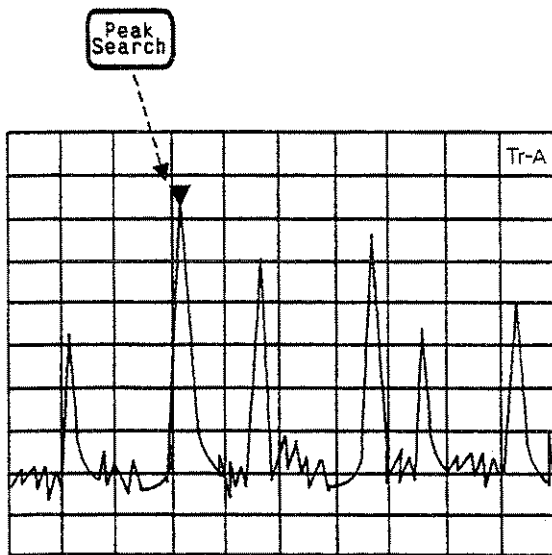

## Next Peak Search

Next Peak Search detects the next largest peak relative to the current marker level and moves the marker to that point. (When there are two or more peaks with the same level on the screen, the leftmost peak is detected.)

Execute Next Peak search by performing the following key operations.

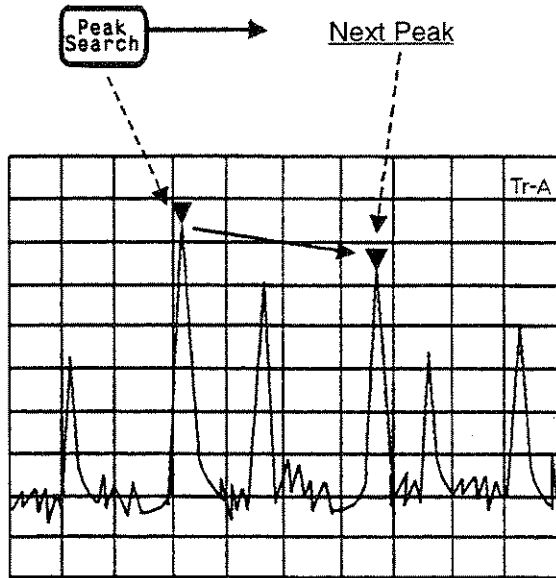

The next largest peaks can be detected and the marker can be moved to those peaks by executing Next Peak Search consecutively.

## Next Right Peak Search/Next Left Peak Search

Next Right Peak search and Next Left Peak Search detect the adjacent peak level to the right or left of the current marker and move the marker to that point.

To execute Next Right Peak Search and Next Left Peak Search, perform the following key operations.

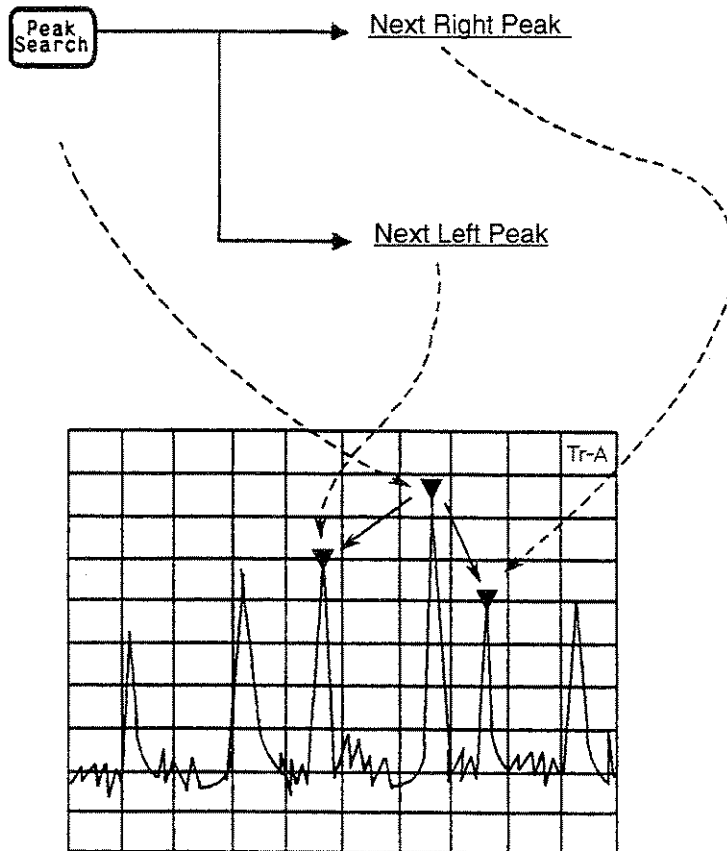

The adjacent peak level to the right or left can be detected and the marker moved to that peak by executing Next Right Peak Search or Next Left Peak Search consecutively.

**Note:** When marker search is executed, the marker is moved to the specified Peak or Dip point, and the zone marker center frequency is simultaneously moved to the marker point. After that, when sweep is executed within the zone marker, the marker moves to the maximum point within the zone marker. Therefore, marker search other than Peak search should be executed with sweep stopped or with the zone width set to 1 point (spot marker mode).

## Dip Search

Dip search detects the minimum level point from the entire trace in which a marker is displayed and moves the marker to that point.

Execute Dip search by the performing the following key operations.

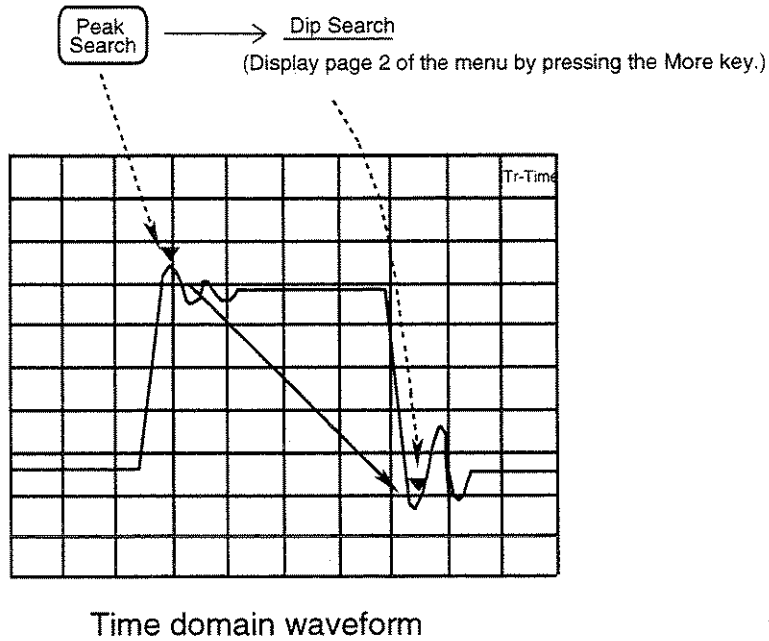

## Next Dip Search

Next Dip Search detects the next smallest dip relative to the current marker level and moves the marker to that point. (When there are two or more dips with the same level on the screen, the leftmost dip is detected.)  
 Execute Next Dip Search by performing the following key operations.

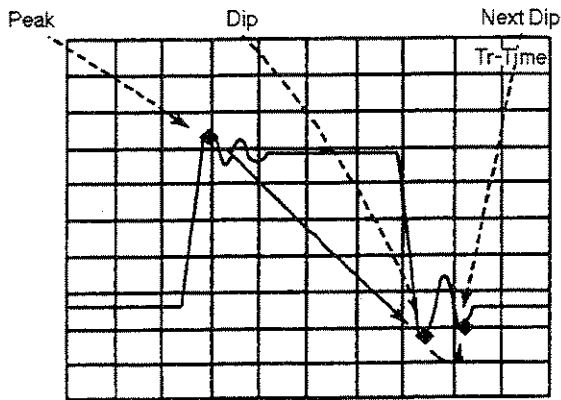
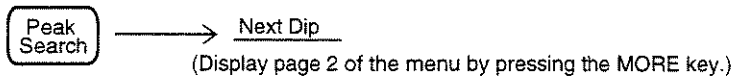

Time domain waveform

The next smallest peaks can be detected one by one and the marker moved to the detected peaks by executing Next Dip Search consecutively.

## Setting Search Resolution

Sets the Peak and Dip search resolution. When searching for the next peak, etc., the marker moves to the point of the set resolution or higher.

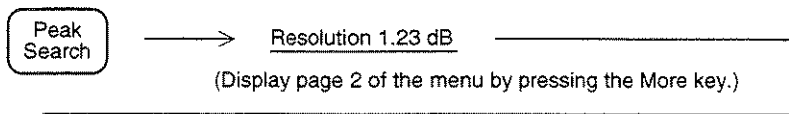

Enter the resolution in dB units from the ten keys.

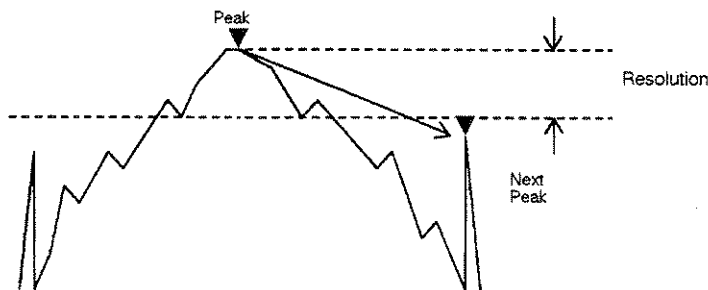

# Setting Search Threshold

Sets the display line to the threshold and searches for the level above or below the display line.

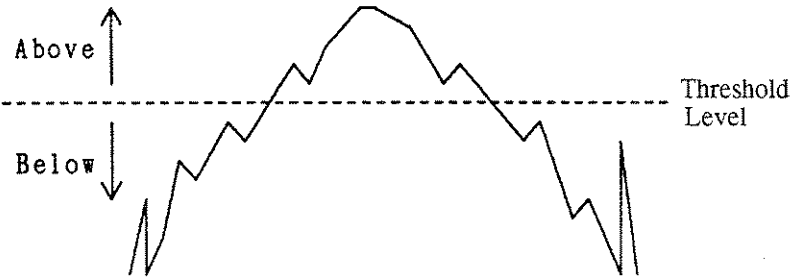
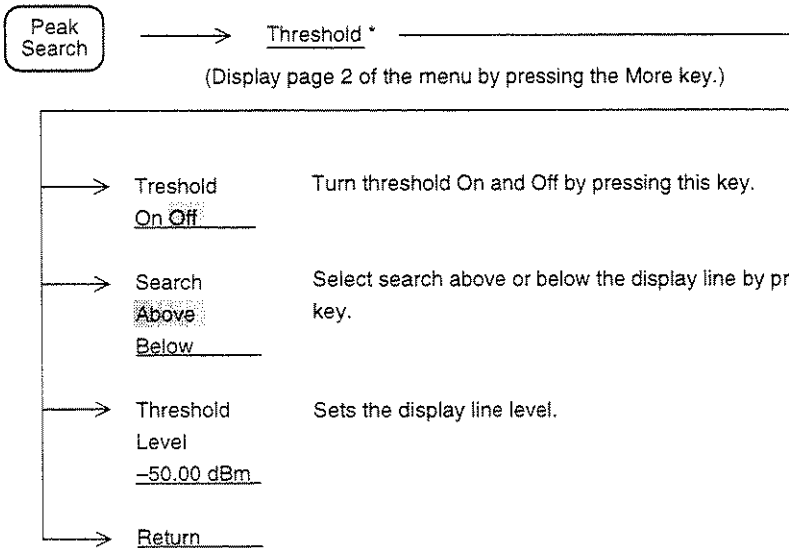

## Setting Parameters Using Marker Values

The marker value can be set as the parameter value of the observation frequency, reference level, and so on. This facilitates observation of the desired waveform.

To set parameters using the marker value, the following settings are possible:

- Mkr → CF            Sets the marker frequency to the center frequency.
- Mkr → RLV         Sets the marker level to the reference level.
- Mkr → CF Step Size   Sets the marker frequency to the center frequency step size.
- Delta Mkr → Span   Sets the reference marker and current marker frequency to the start frequency and stop frequency, respectively.
- Zone → Span        Sets the zone marker center frequency and zone width to the center frequency and frequency span, respectively.

In the time domain mode, only Mkr → RLV is valid.

Mkr → CF/Mkr → RLV

Sets the current marker frequency or level to the center frequency or reference level.

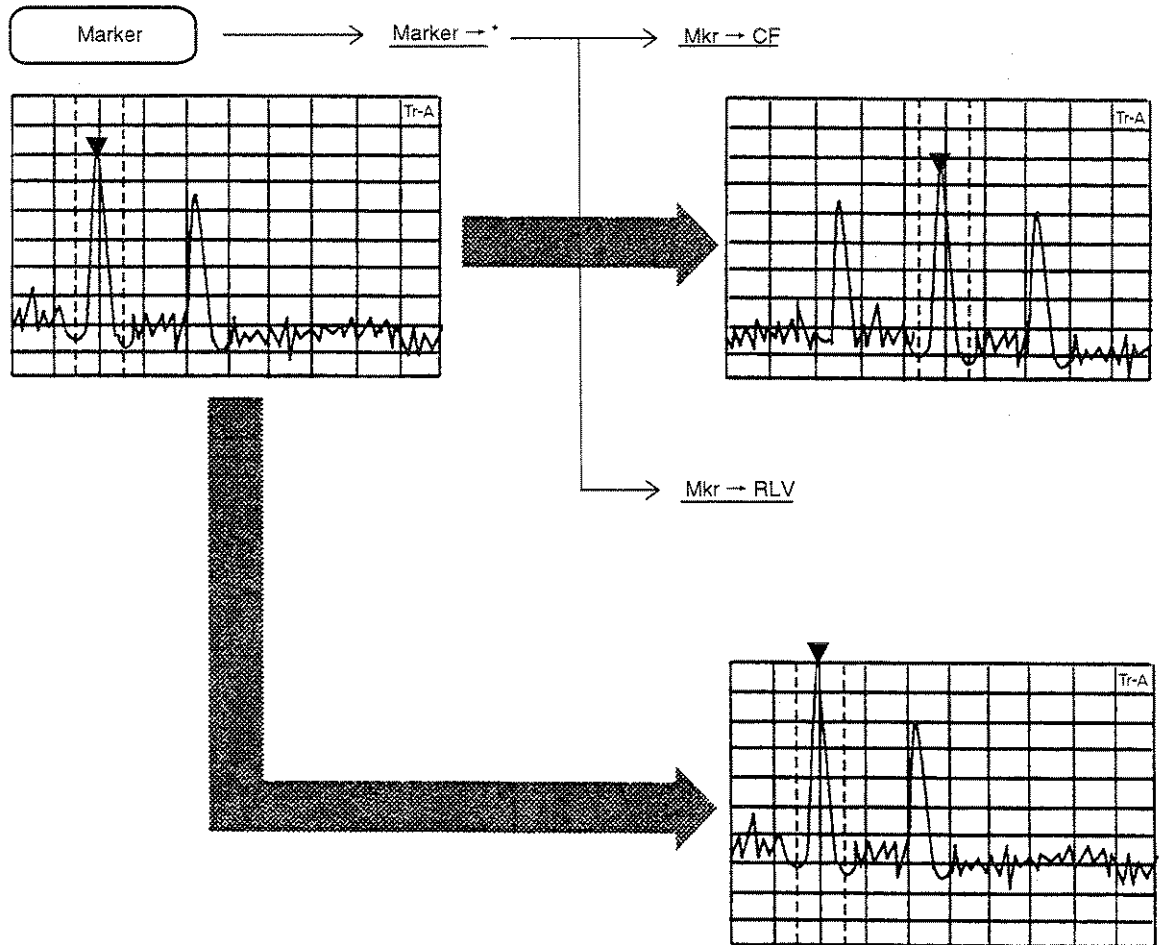



**Mkr → CF Step Size**

Sets the marker frequency to the center frequency step size (up-down keys resolution).

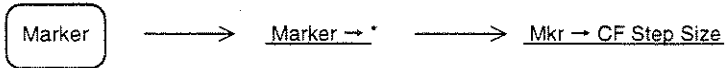

Although this action does not cause any change to appear on the screen, when the center frequency is changed with the up-down keys, the center frequency is changed with the marker frequency as the step size. This facilitates observation of harmonic waves.

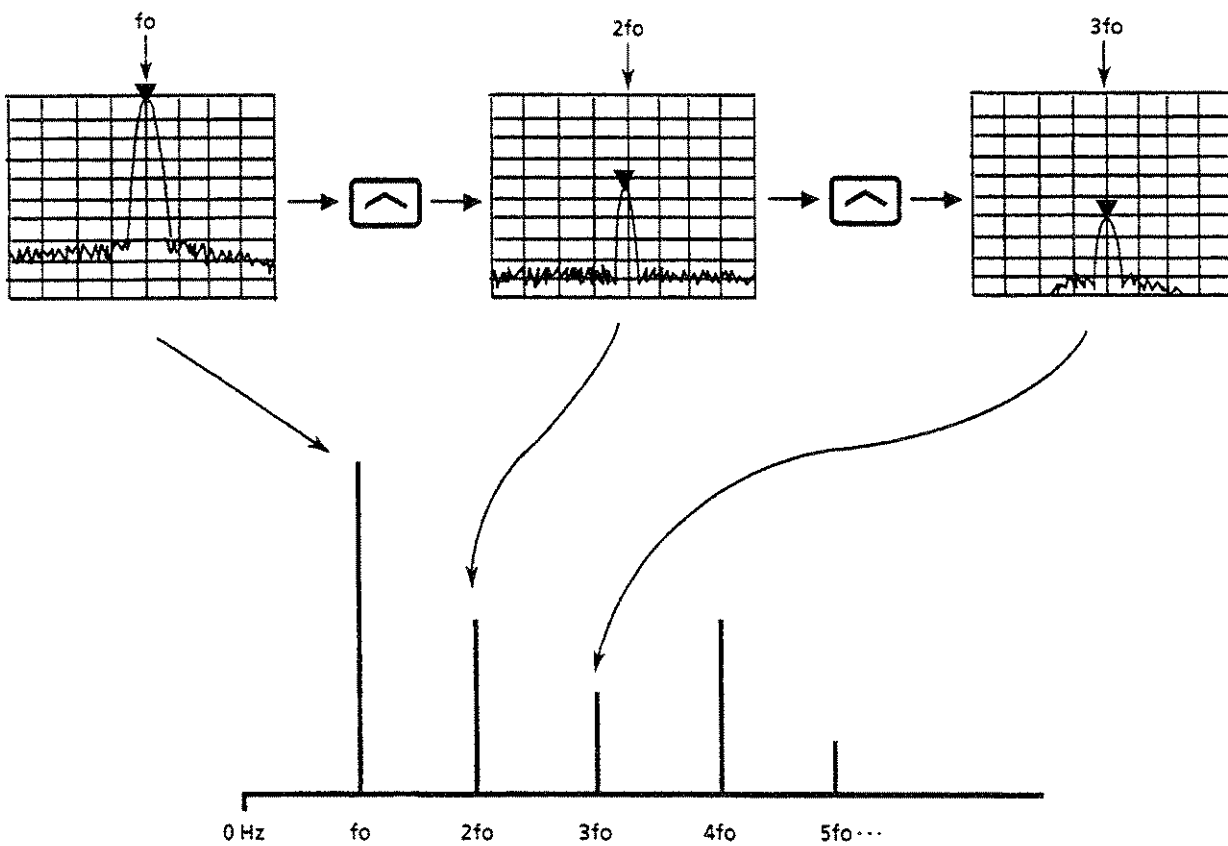

## Delta Mkr → Span

In the delta marker mode, this operation sets the delta marker mode current marker frequency and reference marker frequency to the start frequency and stop frequency, respectively.

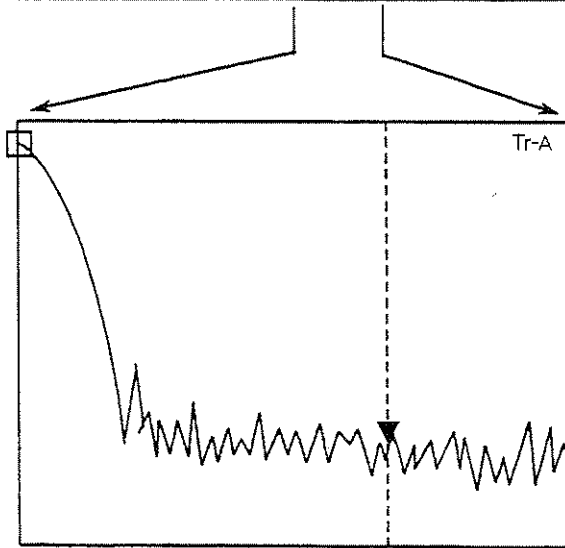
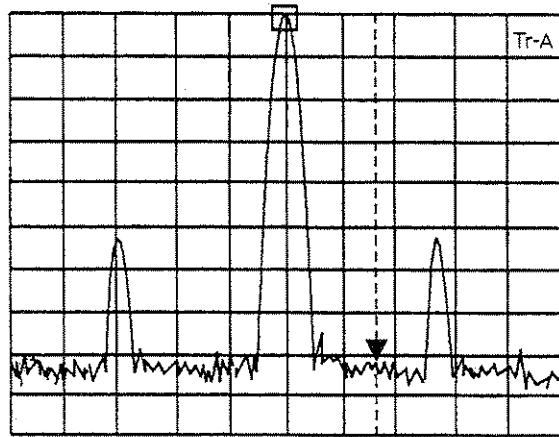
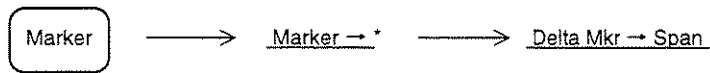

The normal marker position remains unchanged.

Since the reference marker is fixed relative to the frequency, it moves to the extreme left when the frequency span is changed.

**Zone → Span**

To set the zone marker center frequency and width to the center frequency and frequency span, respectively, perform the following key operations.

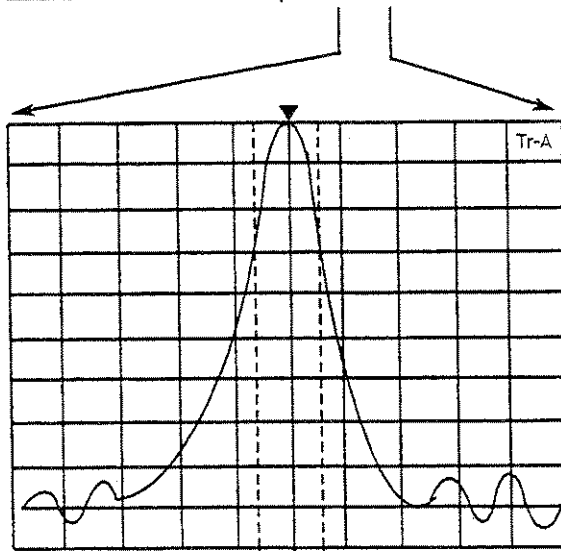
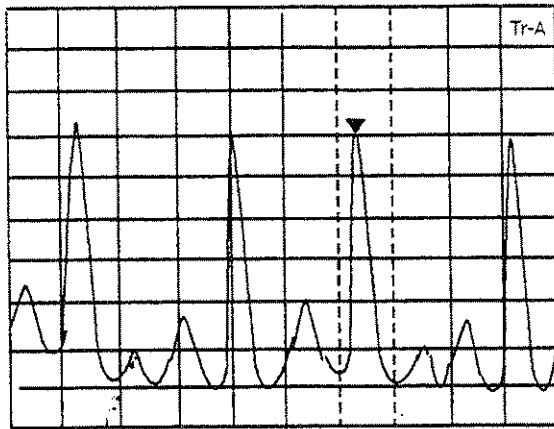
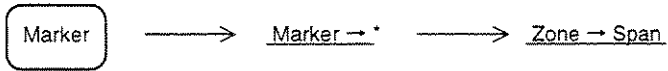

The zone width remains unchanged.

# SECTION 4

## SIGNAL SEARCH FUNCTION

Signal search facilitates extraction of the objective signal. Although the functions of signal search are similar to the marker function, this section only describes the Signal Search section.

### TABLE OF CONTENTS

Detecting Peaks .....	4-3
Detecting the Maximum Peak Signal by Automatic Tuning .....	4-4
Moving the Measurement Point .....	4-5
Peak → CF and Peak → RLV .....	4-6

# SECTION 4 SIGNAL SEARCH FUNCTION

## Detecting Peaks

The spectrum analyzer has the following three peak detection functions:

- Auto Tune
- Zone Marker
- Marker Tracking

SECTION 3 MARKER FUNCTION describes the Zone Marker function and SECTION 6 SELECTING THE SWEEP METHOD describes the Marker Tracking function.

## Detecting the Maximum Peak Signal by Automatic Tuning



Pressing the Auto Tune key detects the maximum peak signal within the Back Ground (BG) and sets that signal frequency and level to the center frequency and reference level, respectively.

- Notes:
- When executed at a frequency span of more than 100 MHz, the frequency span is set to 100 MHz. When executed at a frequency span of less than 100 MHz, that value is retained.
  - When the Display mode was executed by trace Time, the instrument switches to trace A/Time and trace Time becomes the main trace. Also the Expand mode is set to Off.
  - The input attenuator is set to Auto.
  - In the initial state, the Auto Tune frequency range is set to 90 MHz to 3 GHz for the MS2651B/MS2661B/2661C, and 250 MHz to 8.1 GHz for the MS2653B/MS2663B/2663C. By changing the trace BG frequency range, the Auto Tune frequency range can also be set as follows:

Start frequency

Start frequency specified in trace BG

However, except the 0 Hz to 3/100 frequency span range.

Stop frequency

Stop frequency specified in trace BG.

# Moving the Measurement Point

This function moves the spectrum on the screen to the center to facilitate measurement. The following five functions can be used.

- Mkr → CF                      Sets the marker frequency to the center frequency.
- Mkr → RLV                     Sets the marker level to the reference level.
- Peak → CF                     Sets the frequency of the maximum point on the screen to the center frequency.
- Peak → RLV                    Sets the level of the maximum level point on the screen to the reference level.
- Scroll → , Scroll ←         Scroll the observation frequency.

SECTION 3 MARKER FUNCTIONS describes the Mkr → CF and Mkr → RLV functions. SECTION 2 FREQUENCY/AMPLITUDE DATA ENTRY describes the scroll function.

This section describes the Peak → CF and Peak → RLV functions.

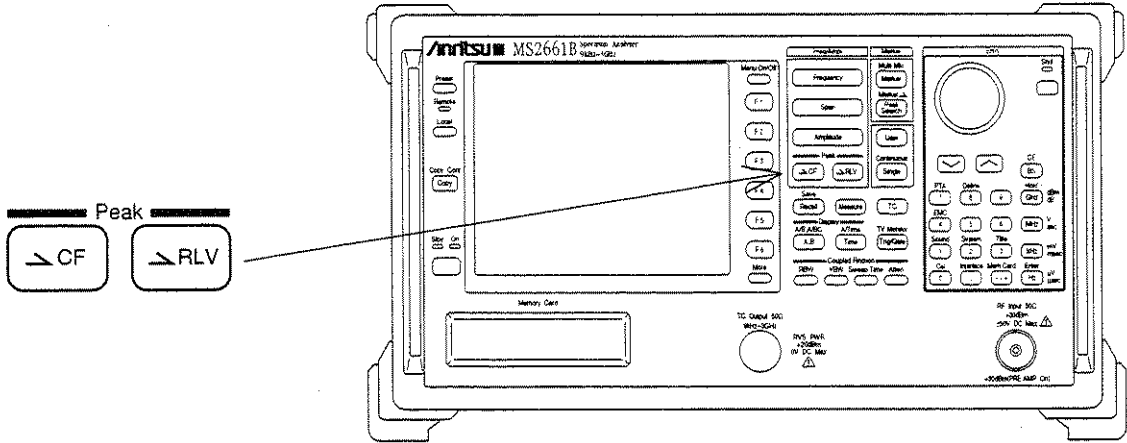

## Peak → CF and Peak → RLV

The Peak → CF and Peak → RLV functions set the maximum level value displayed on the screen to the center frequency and reference level, respectively, and move the peak point to the center of the frequency axis on the screen and to the top level axis, respectively.

### (1) Peak → CF

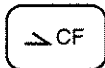

Sets the maximum peak point and the zone marker to the center frequency.

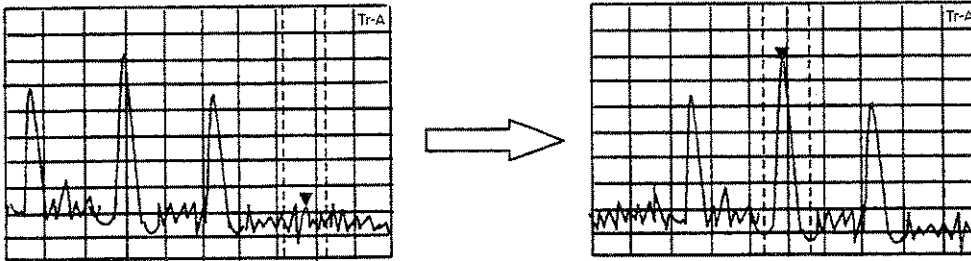

- Notes:
- When the frequency at the maximum peak point is less than 0 Hz, the center frequency is set to 0 Hz.
  - If there are two or more maximum peak points with the same level on the screen, the peak point with the lowest frequency is moved to the center frequency.
  - Peak → CF does not operate in the following cases:
    - ① When zone sweep is On
    - ② In the time domain mode
    - ③ When A<Time is specified in the A/Time mode

### (2) Peak → RLV

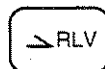

Sets the maximum peak level to the reference level.

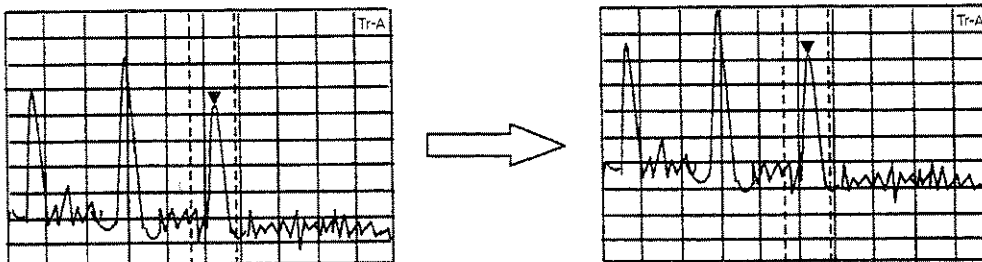

- Note:
- If the level at the peak point exceeds the permitted range for the reference level, the reference level is set to the maximum (minimum) reference level that can be set.
  - If the level at the peak point exceeds the reference level(scale over), one operation of the Peak → RLV may not be able to set the correct reference level. In this case, repeat the Peak → RLV operations a few times.



## SECTION 5

### SELECTING THE DISPLAY METHOD

This sections gives a detailed description of the display modes (Trace A/B, A/B, A/BG, Trace Time, A/Time), storage modes (Normal, Max Hold, Min Hold, Average, View, Cumulative, Overwrite), detection modes (Normal, Pos Peak, Sample, Neg Peak) and time domain analysis.

### TABLE OF CONTENTS

Display Mode .....	5-3
Trace A .....	5-5
Trace B .....	5-6
Moving the Trace .....	5-6
Trace Computation .....	5-7
Trace A and Trace B Overwrite Display .....	5-8
Setting Active Trace .....	5-8
Trace A/Trace B Top and Bottom Split Display .....	5-9
Setting Sub-trace Sweep .....	5-10
Trace A/Trace BG Top and Bottom Split Display .....	5-11
Trace Time .....	5-12
Trace A/Trace Time Top and Bottom Split Display .....	5-14
Storage Mode .....	5-15
Setting Storage Mode .....	5-17
Averaging Function .....	5-18
Max hold, Min hold Function .....	5-21
Detection Mode .....	5-22
Selecting Detection Mode .....	5-23
Selecting Measured Level by Detection Mode .....	5-24
Time Domain .....	5-26
Setting Time Domain .....	5-26
Setting Time Span .....	5-27
Time Domain Expanded Display .....	5-28
Monitoring FM Demodulated Waveforms .....	5-30

# SECTION 5 SELECTING THE DISPLAY METHOD

The spectrum analyzer can display four trace modes (BG †, A, B, Time) in six Display modes (A, B, Time, A/B, A/BG, A/Time).

In the Display mode, the two keys of the Display section shown below are used.

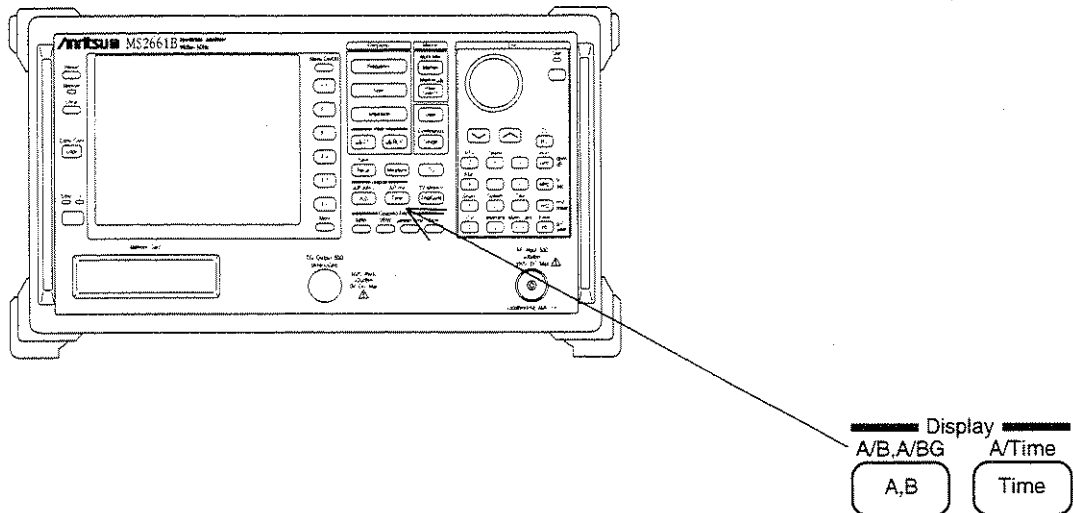

## Display Mode

The following outlines the trace modes. The figure on the next pages shows the correlation between trace modes.

- Trace BG ..... When the objective signal is measured in the trace A, B, or Time mode, the trace BG mode allows the frequency range to be observed to be pre-set to a wide band. The BG band is initially set to full span (0 to 3 GHz or 8.1 GHz).
- Trace A, trace B ..... Used to analyze signals in the normal frequency domain. The BG zone within trace BG is expanded and displayed. Different frequency range can be observed by Trace A and Trace B.
- Trace Time ..... Displays the time axis waveform at the center frequency of trace A. Trace Time can also display FM and EXT TRIG input signals, when monitored.

† BG (Back Ground)

SECTION 5 SELECTING THE DISPLAY METHOD

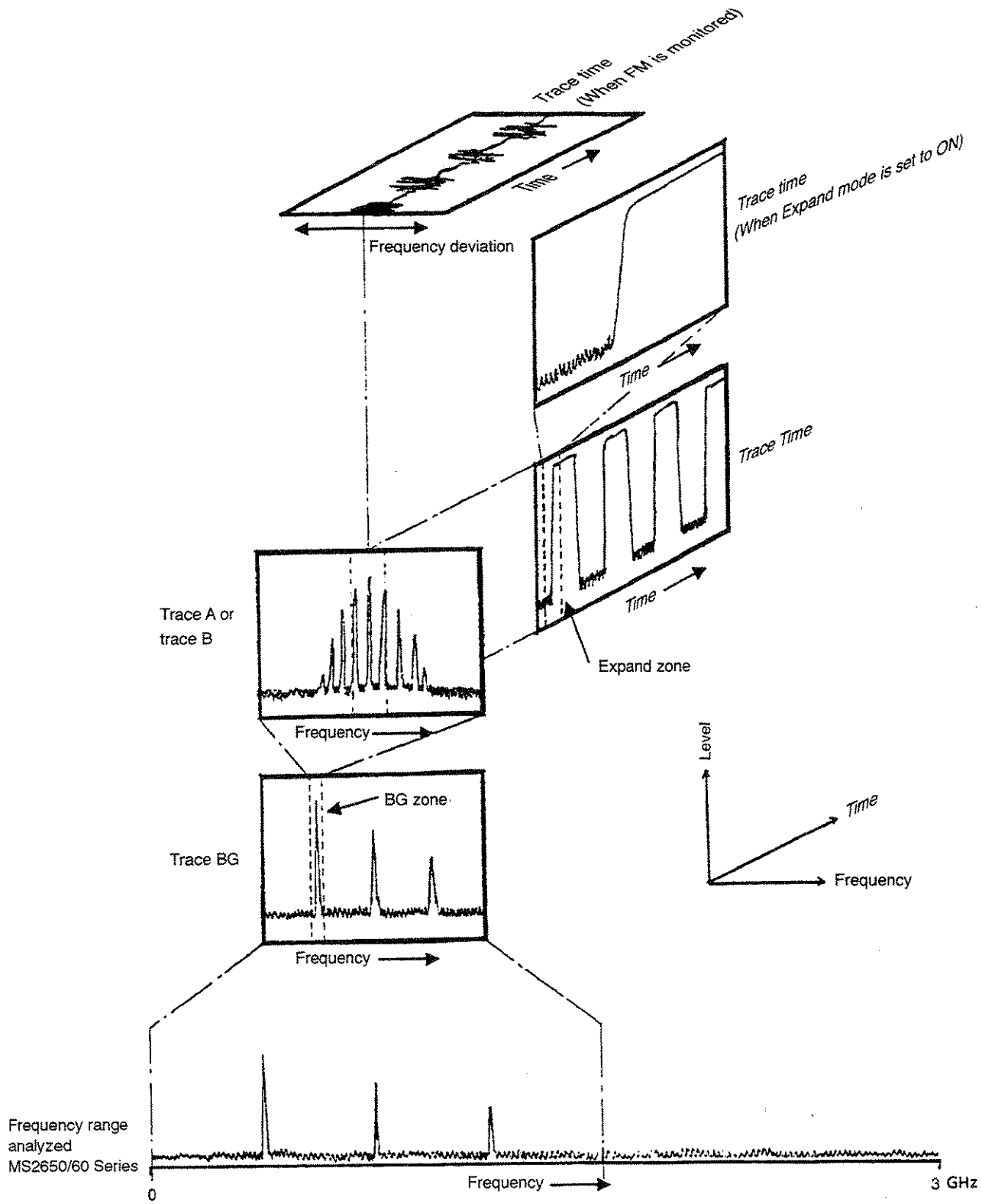

Trace A

Trace A is used to analyze signals in the normal frequency domain.

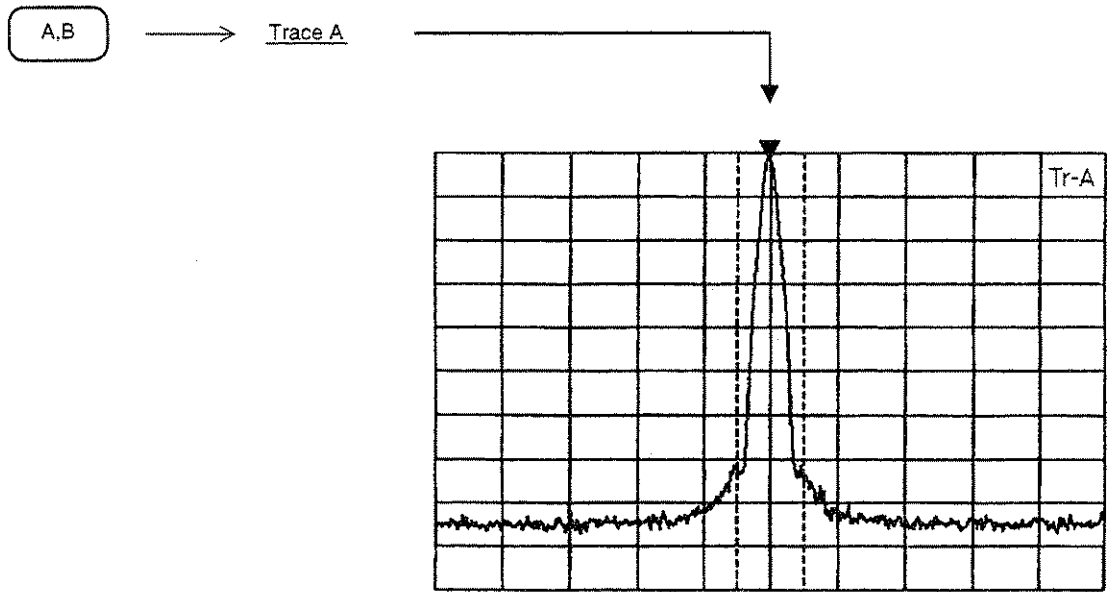

## Trace B

Like trace A, trace B is used to analyze signals in the normal frequency domain. When used with trace A, it is possible to compare waveform A and waveform B.

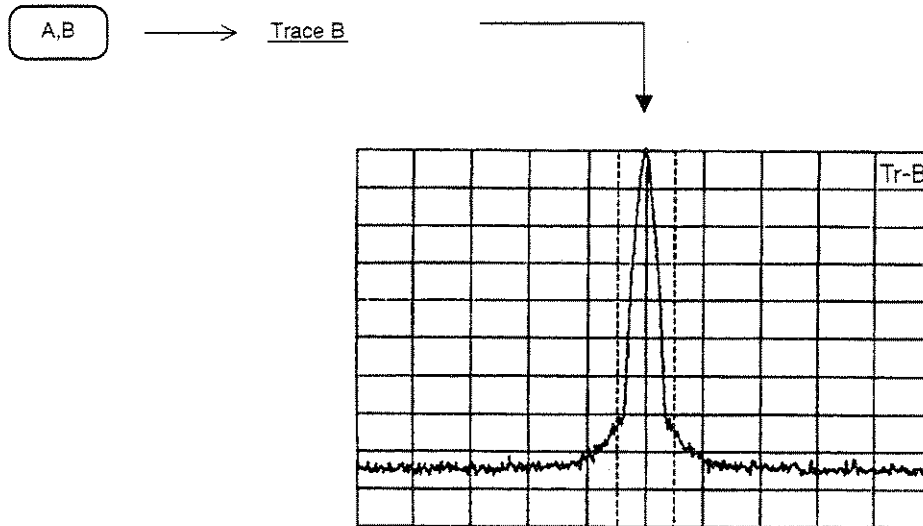

Parameters of the trace A and trace B can be set independently.

## Moving the Trace

This function moves and adds the trace A and trace B displays once.

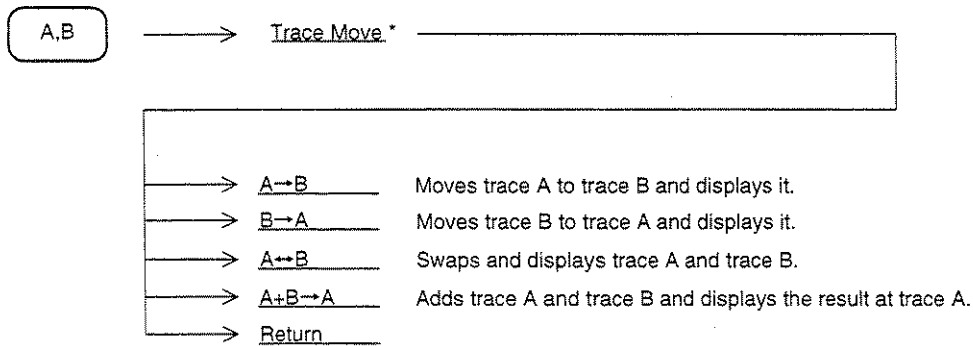

Set the move-destination-trace storage mode to View, and stop the sweeping before moving the trace. If the trace A or trace B threshold is set to any other mode, the trace data will be displayed once, then updated.

## Trace Computation

This function continuously displays the difference between trace A and trace B. Normally set trace B to the View mode before executing this function.

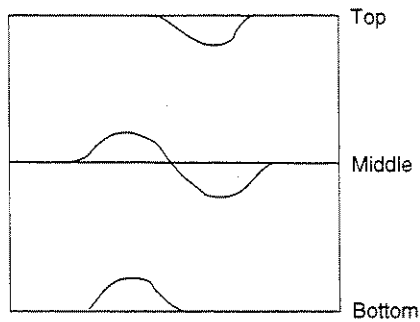
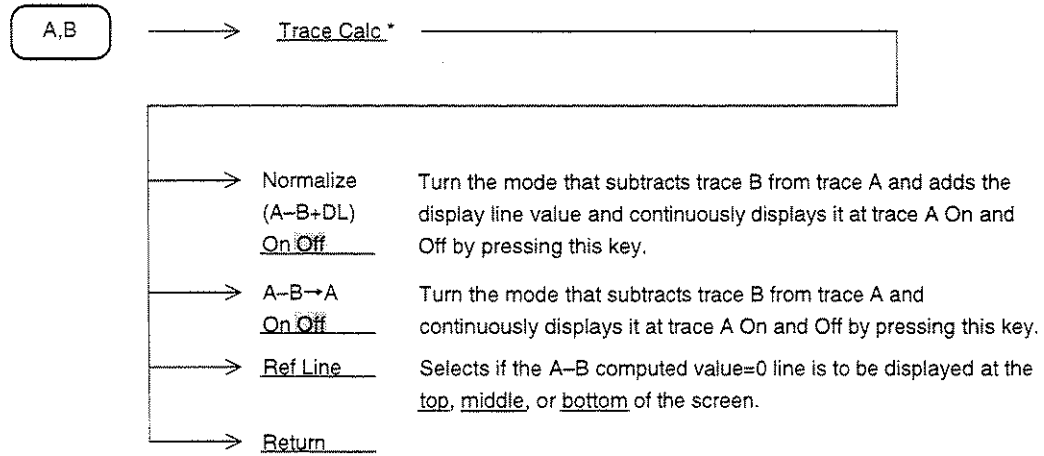

## Trace A and Trace B Overwrite Display

Overwrites trace A and trace B on one screen. At this time, the trace B frequency range, reference level, and other parameters are the same as trace A.

However, in the threshold mode and detection mode, the parameters can be set independently at trace A and trace B. For instance, comparison measurement with a standard waveform and simultaneous observation of the same waveform in a mode different from the normal mode and max hold (or averaging, etc.) mode are possible.

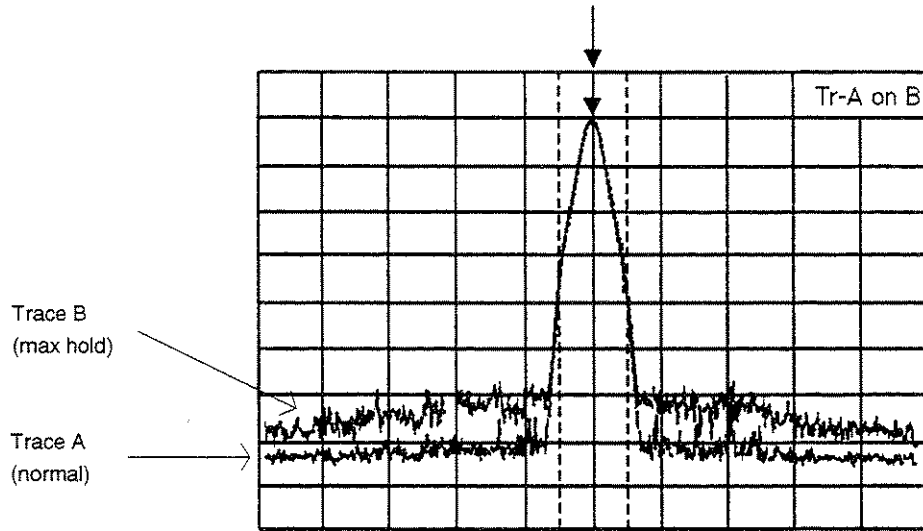
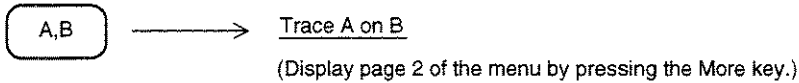

## Setting Active Trace

When trace A and trace B were overwritten on the same screen, select the marker trace by pressing this key.

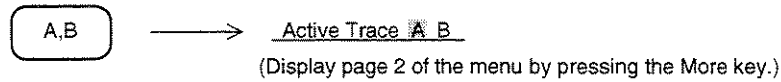

## Trace A/Trace B Top and Bottom Split Display

When trace A and trace B are overwritten and displayed, the setup parameters are common. In this mode, however, the frequency, reference level, and other parameters can be set independently.

For instance, the reference wave can be observed at trace A and harmonics can be simultaneously observed at trace B.

When examining interference, the frequency that is the source of the interference and interference of a different frequency that is generated by the effect of the source frequency can be simultaneously observed.

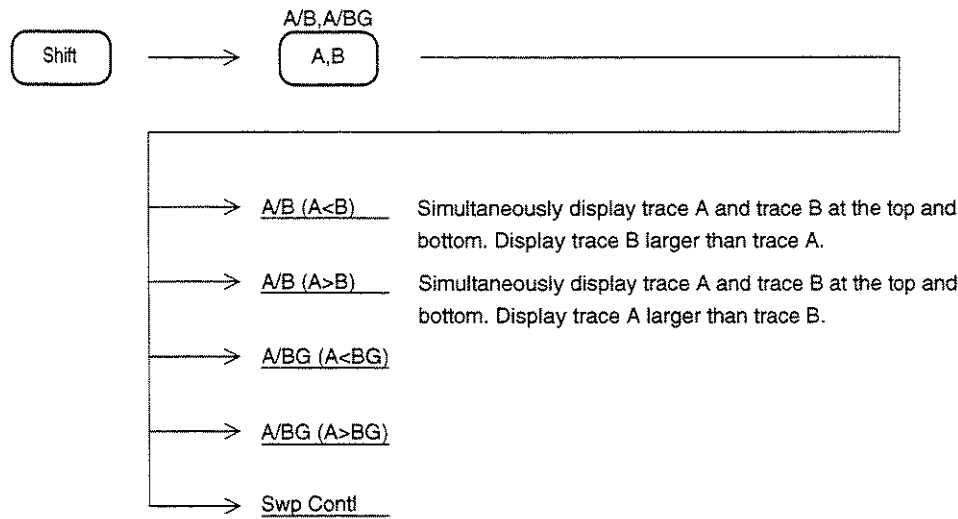

- The large display is called the main trace and the small display is called the sub-trace.

Trace A and trace B are displayed at the top and bottom, respectively.

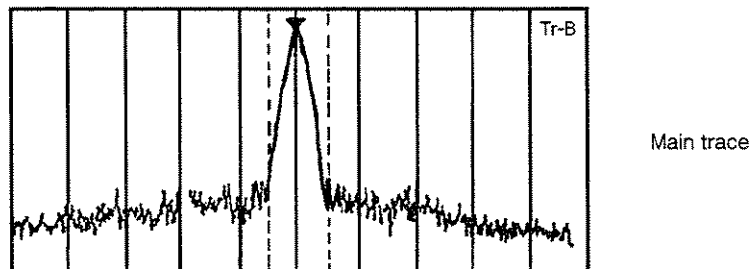
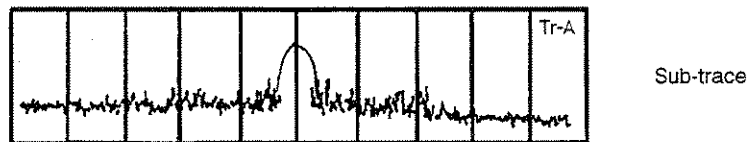

For A/B (A<B)



## Setting Sub-trace Sweep

To set the sub-trace storage mode, perform the following key operations.

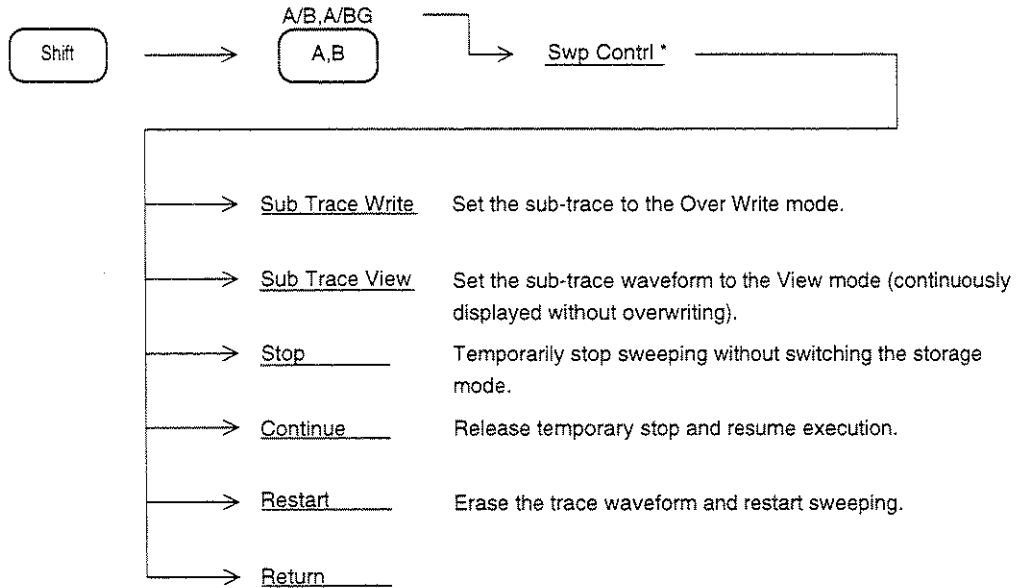

# Trace A/Trace BG Top and Bottom Split Display

This mode simultaneously displays trace A and trace BG. It is used to extract a specific signal from a wide frequency range.

The conditions over a wide surrounding frequency range can be monitored while simultaneously observing the selected signal in detail.

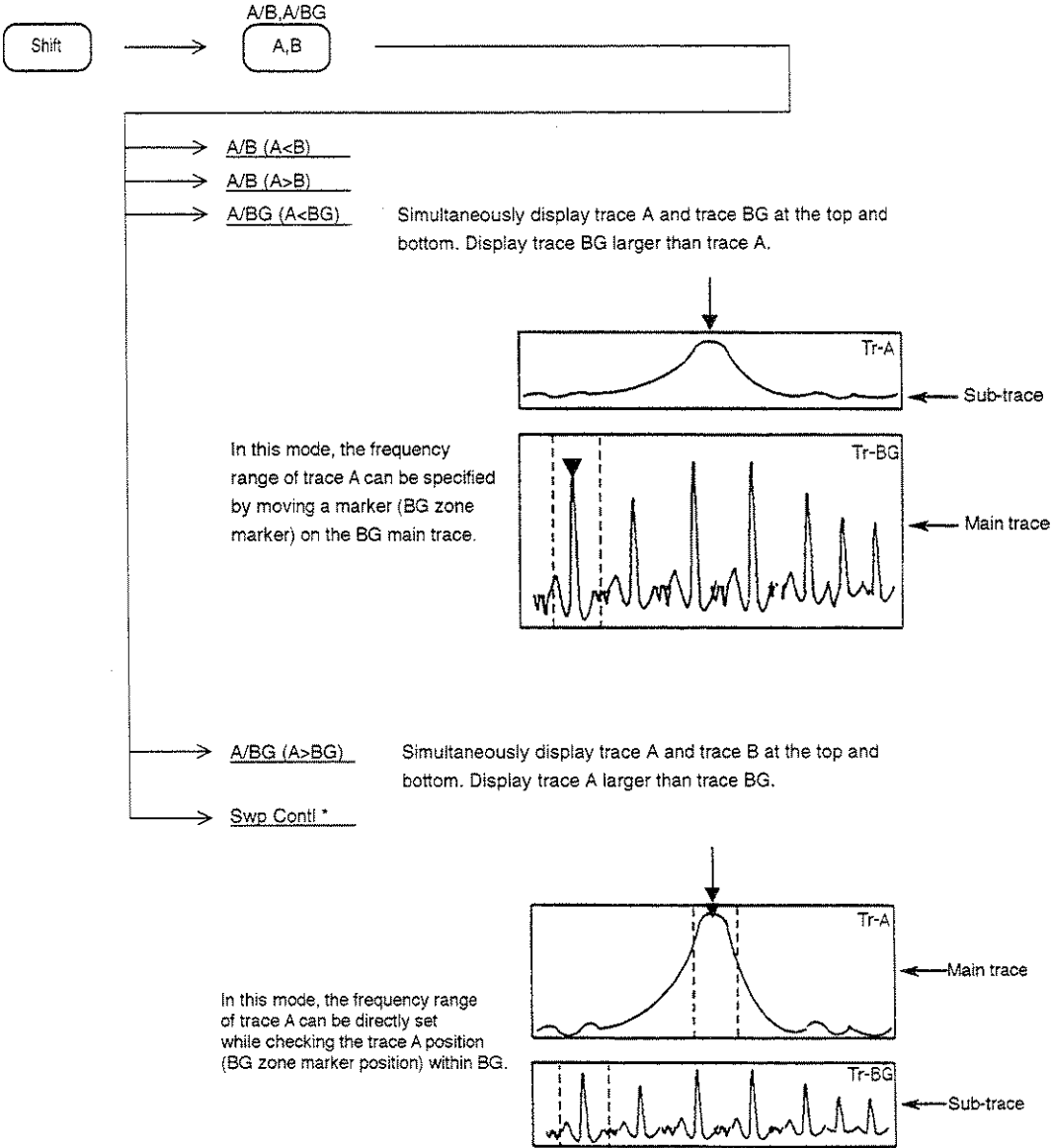

Trace A and trace BG parameters other than reference level, vertical axis scale, and input attenuator settings are used independently. Each parameter can be set in the main trace (larger displayed side). Marker operation is available only for the main trace.

# Trace Time

Trace Time displays the time axis waveform at the center frequency of trace A or trace B. To display trace Time, press the Time key.

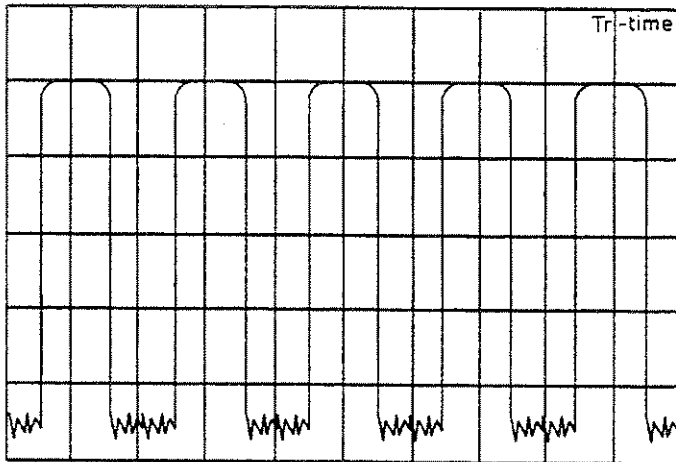

<span style="border: 1px solid black; border-radius: 5px; padding: 2px;">Time</span>	→	Delay Time 10.0 ms	Sets the delay time from trigger to sweep. When a negative value is input, the waveform before the trigger is displayed up to one screen. (See paragraph 6.12 of CHAPTER 6.)
	→	Time Span 200 us	Sets the time span (time domain sweep time).
	→	Trigger <span style="border: 1px solid black; padding: 1px;">Freerun</span> Triggered	Select freerun or trigger sweep by pressing this key.
	→	Trigger Source *	Selects the trigger signal source.
	→	Storage *	Selects the storage display mode.
	→	Detection * 1	Selects the detection mode.
	→	FM Monitor * 2	Displays the FM demodulated waveform.
→	Expand *	Expands and displays part of the time domain waveform.	

(Display page 2 of the menu by pressing the More key.)

Trace-A center frequency and Trace-Time tuning frequency is always common. Other parameters can be set independently. However, the following parameters can be used commonly by "Coupled function common/independent setting mode" of Section 9.

- Resolution bandwidth (RBW)
- Video bandwidth (VBW)
- Sweep time (Sweep Time/Time Span)

## Trace A/Trace Time Top and Bottom Split Display

Trace A/Trace Time top and bottom split display simultaneously displays trace A and trace Time.

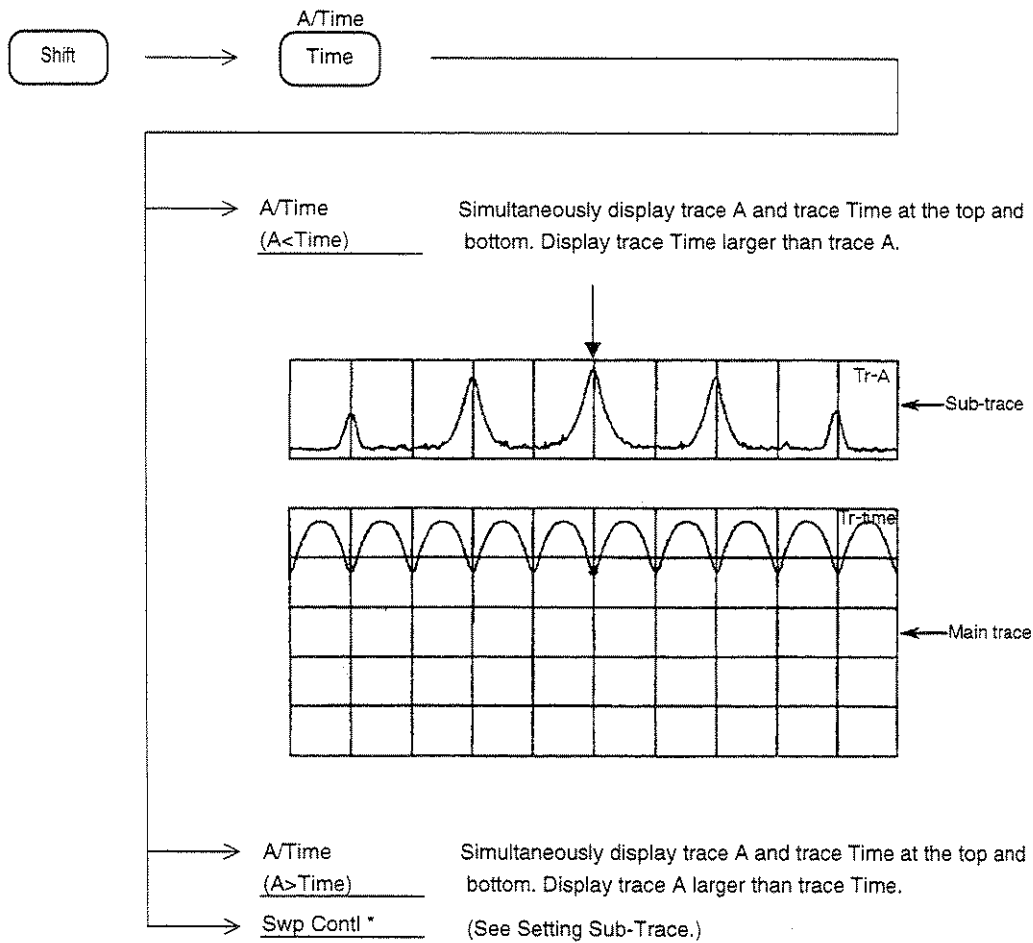

Each parameter can be set in the main trace (larger displayed trace). However, for common parameters (center frequency, reference level, input attenuator, and when system setting is coupled mode resolution bandwidth, video bandwidth, etc.), the sub-trace parameters can also be changed even when setting is performed at the main trace. Marker operation is only available for the main trace.

## Storage Mode

The following seven storage modes can be selected for Display modes trace A, trace B, and trace Time.

Types of Trace Modes (1/2)

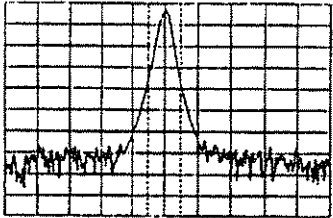
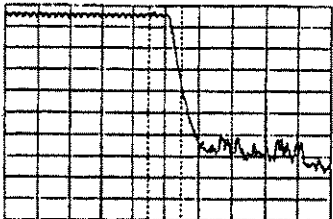
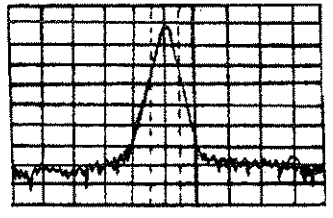
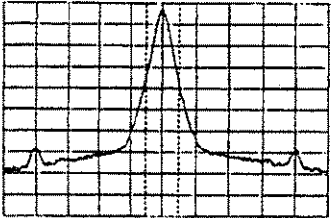
NO.	Mode	Explanation	Display example
1	Normal	Refreshes and displays the trace data at each sweep. This is used for normal measurement.	
2	Max Hold	At each sweep, compares the new trace data with the old data at each X axis point, then displays the larger value data. It is used to record a frequency-drifting signal.	
3	Min Hold	At each sweep, compares the new trace data with the old data at each X axis point, then displays the smaller value data.	
4	Average	At each sweep, calculates the average data at each X axis point, then displays the averaged results. This mode is used to improve the S/N ratio. For further details on the averaging function, see page 5-18.	

SECTION 5 SELECTING THE DISPLAY METHOD

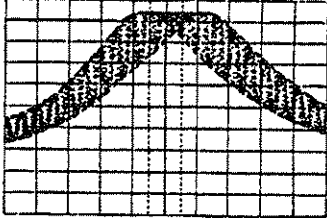
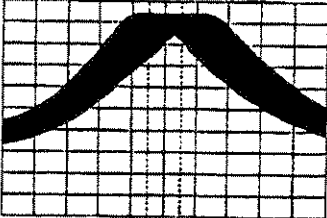
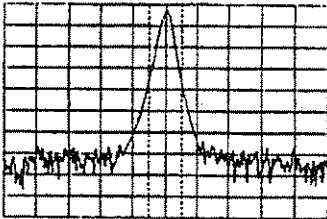
NO.	Mode	Explanation	Display example
5	Cumulative	Displays the cumulative waveform at each sweep. The waveform data, which are not connected by lines, are displayed by plotting the data.	
6	Over write	Displays the waveform overwritten without deleting the old trace data.	
7	View	Continues displaying the waveform as it is, without refreshing the currently-displayed trace data. This mode is used to observe waveforms with the trace data stopped temporarily.	

# Setting Storage Mode

The storage mode can be selected by operating the function keys shown below while the spectrum analyzer is operating in the trace A, trace B, or trace Time mode.

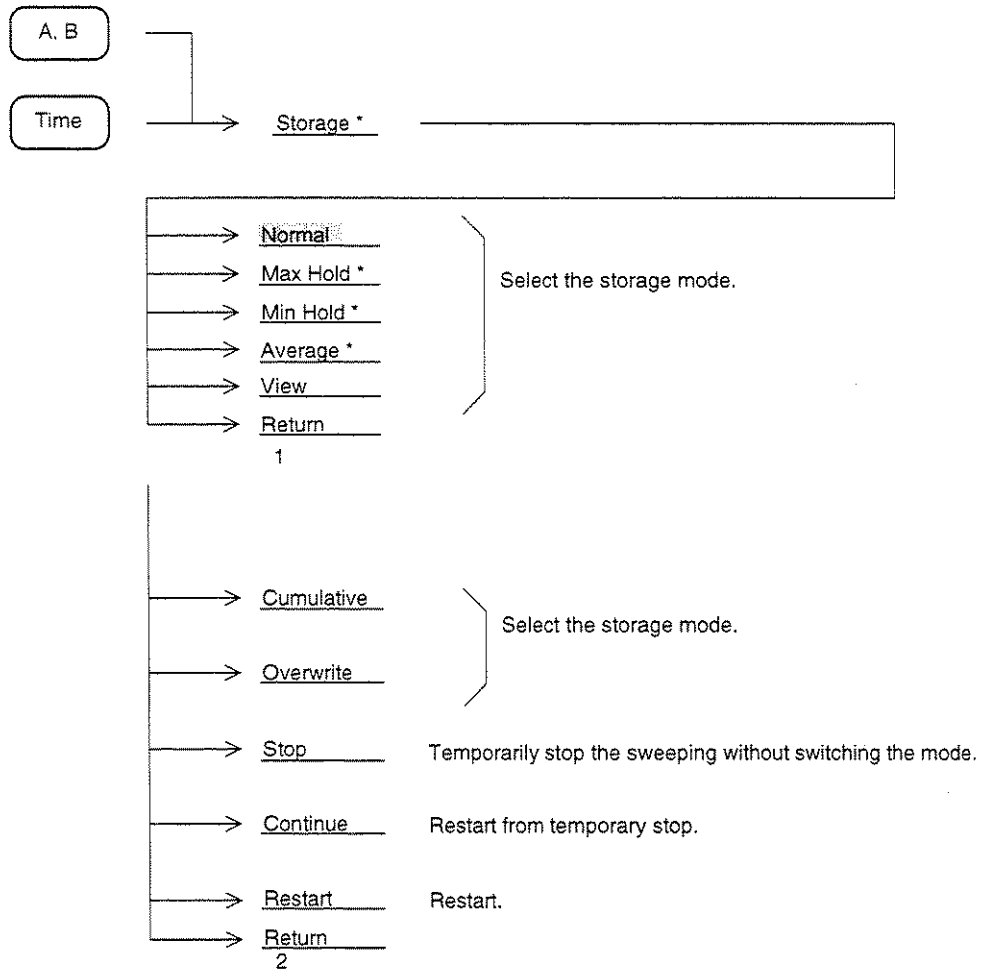

(Display page 2 of the menu by pressing the More key.)



## Averaging Function

The digital averaging function calculates the average data at each X axis point at each sweep and displays the results. It is executed by selecting Average in the trace A, trace B, and trace Time display modes.

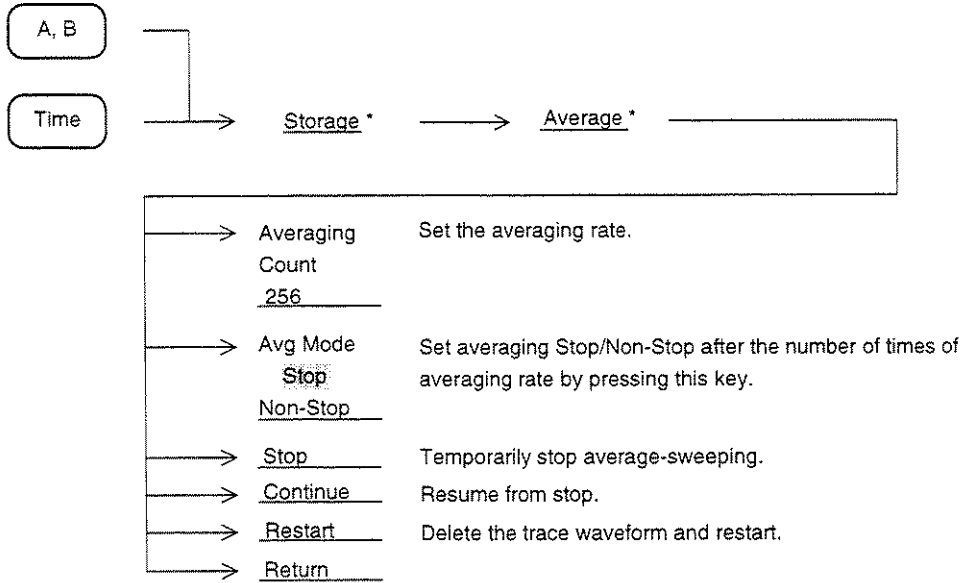

The averaging function improves the S/N ratio depending on the averaging rate and the number of sweep repetitions as shown on the next page.

Digital video averaging is performed by the method shown below.

### Averaging Rate = N

	Number of sweep repetitions	Measurement value	Displayed value
③ Restart	1	M (1)	$Y (1) = M (1)$
	2	M (2)	$Y (2) = Y (1) + \frac{M (2) - Y (1)}{2}$
	3	M (3)	$Y (3) = Y (2) + \frac{M (3) - Y (2)}{3}$
	⋮	⋮	⋮
	N-1	M (N-1)	$Y (N-1) = Y (N-2) + \frac{M (N-1) - Y (N-2)}{N-1}$
① Stop	N	M (N)	$Y (N) = Y (N-1) + \frac{M (N) - Y (N-1)}{N}$
② Continue	N+1	M (N+1)	$Y (N+1) = Y (N) + \frac{M (N+1) - Y (N)}{N}$
	N+2	M (N+2)	$Y (N+2) = Y (N+1) + \frac{M (N+2) - Y (N+1)}{N}$
	⋮	⋮	⋮

- ① Sweep stops after N repetitions. (When Avg Mode is Stop)
- ② The above stop condition is released by restarting sweep by Continue. The averaging operation resumes, while counting the number of sweep repetitions as N+1, N+2....
- ③ When Restart is performed during sweep or Stop, averaging is repeated from sweep count 1.

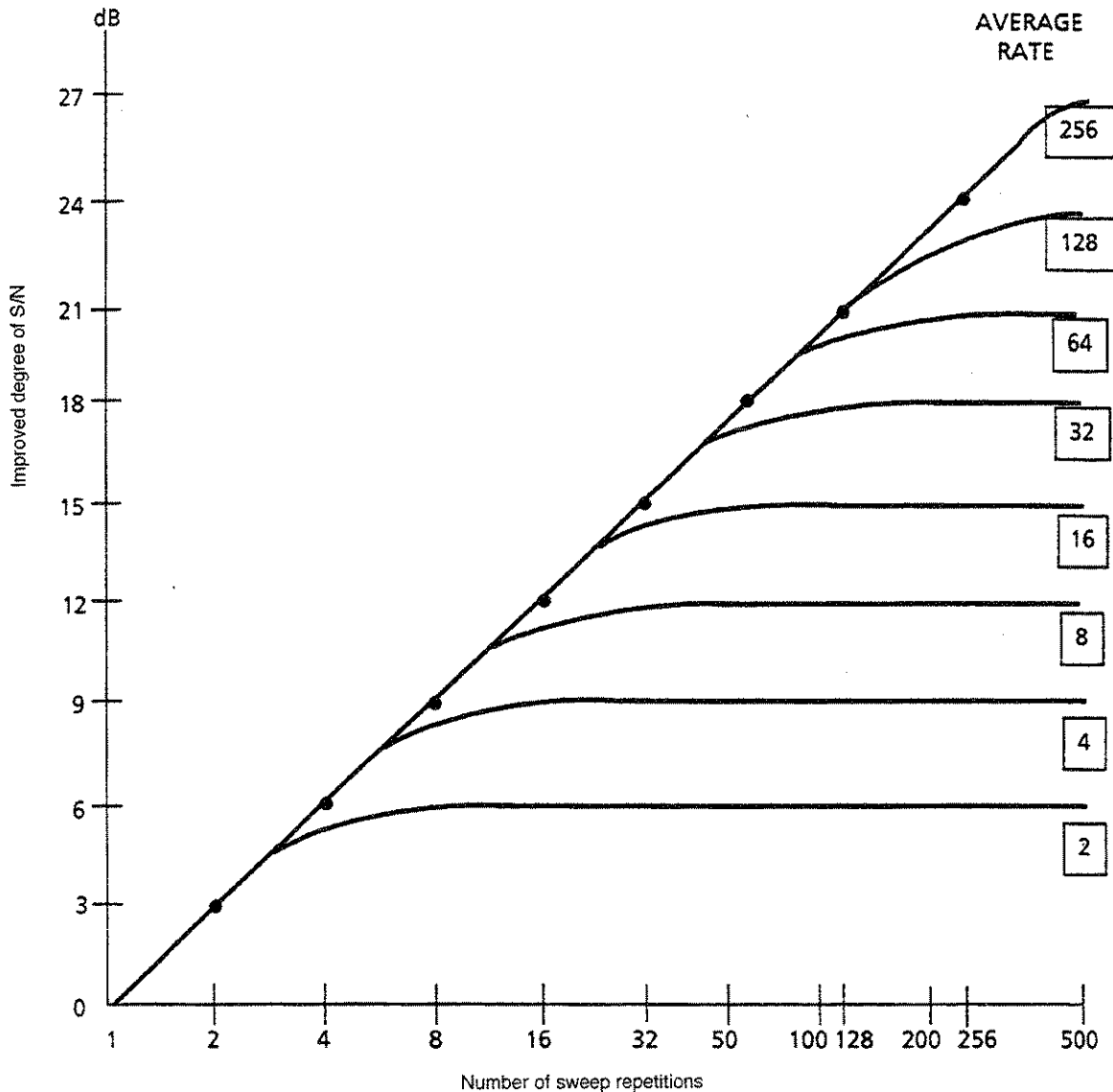

S/N Improvement by Digital Video Averaging

Averaging by video filter has the disadvantage that the sweep time becomes longer when the video bandwidth is narrowed to improve the averaging effect.

On the other hand, digital video averaging smooths the trace display by averaging the digital data after A/D conversion at each sweep, without narrowing the video bandwidth (VBW). Since the video bandwidth (VBW) gets comparatively wider and the time required for each sweep can be shortened, the entire spectrum image can be verified quickly and the repetitive sweep can be stopped when the required smoothing has been obtained. The problem of averaging with the video filter is that the time required for each sweep becomes longer and it takes a long time to verify the entire spectrum image.

Since the averaging rate is initially eight, the above figure shows that an S/N improvement of 9 dB is obtained with eight sweeps.

# Max Hold and Min Hold Functions

When Max Hold or Min Hold is selected, the sweeping can be performed by the number of specified repetitions, and then stops.

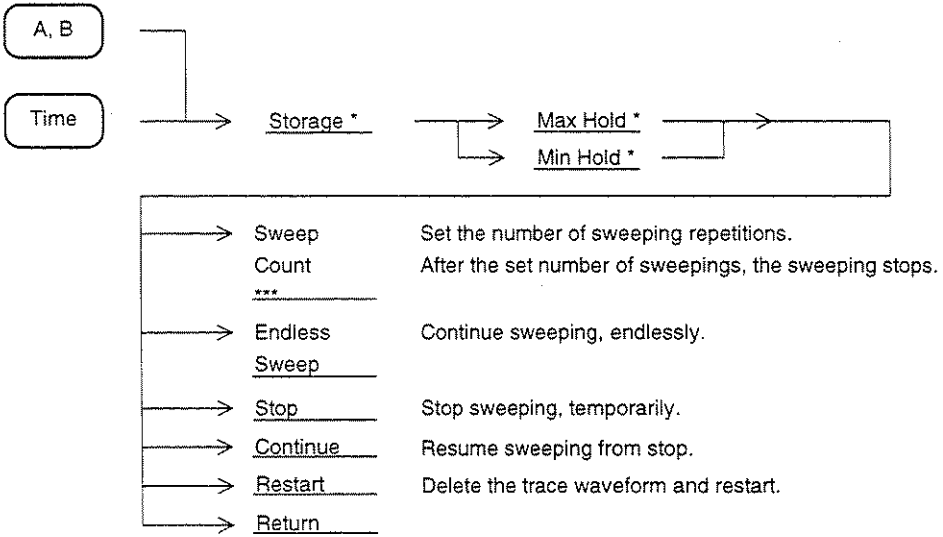

## Detection Mode

The detection mode can be selected from among Normal, Pos Peak, Sample, and Neg Peak for trace A and trace B.

Normal	Traces the maximum value and minimum value between sample points.
Pos Peak	Traces the maximum value between sample points.
Sample	Traces the instantaneous value between sample points.
Neg Peak	Traces the minimum value between sample points.

However, trace BG is fixed at Pos Peak.

When the time span is under 20 ms at trace Time, only Sample is available.

## Selecting Detection Mode

Select the detection mode for trace A, trace B, or trace Time by performing the following key operations.

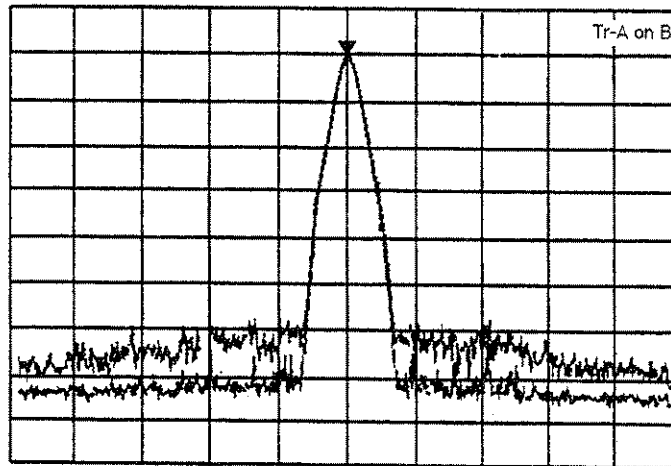
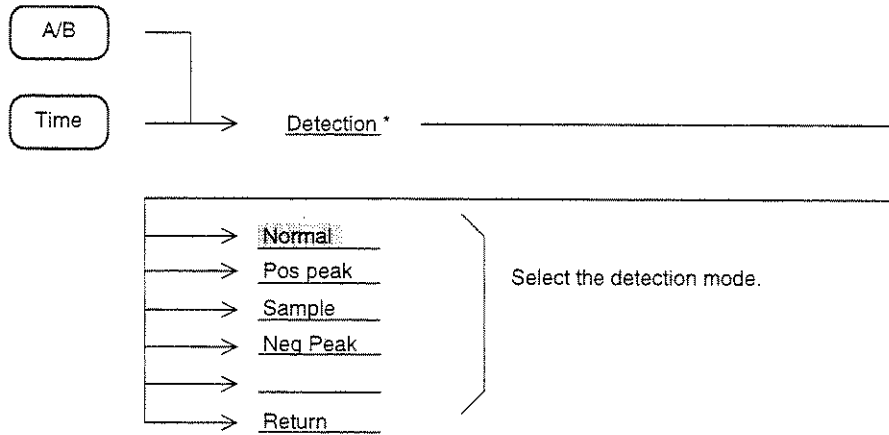

Waveforms when trace A is in the Pos Peak mode and trace B is in the NegPeak mode

## Selecting Measured Level by Detection Mode

The spectrum analyzer has 501 horizontal-axis measurement sample points. This corresponds to 501 storage trace memories.

The detection mode determines what type of measured value should be stored in the trace memory at each measurement sample point.

Detection mode	Description
Normal	Stores both the maximum level and the minimum level present between the current sample point and the next sample point and displays them on the screen. This mode is used in normal measurement.
Pos Peak	Holds the maximum level present between the current sample point and the next sample point, then stores the maximum value in the trace memory corresponding to the current sample point. Pos Peak is used to measure the peak value of signals near the noise level.
Sample	Stores the instantaneous signal level at each sample point to the trace memory. Sample is used for noise level measurement, time domain measurement, and other measurements.
Neg Peak	Holds the minimum level present between the current sample point and the next sample point, then stores the minimum value to the trace memory corresponding to the current sample point. The Neg Peak mode is used to measure the lower envelope side of a modulated waveform.

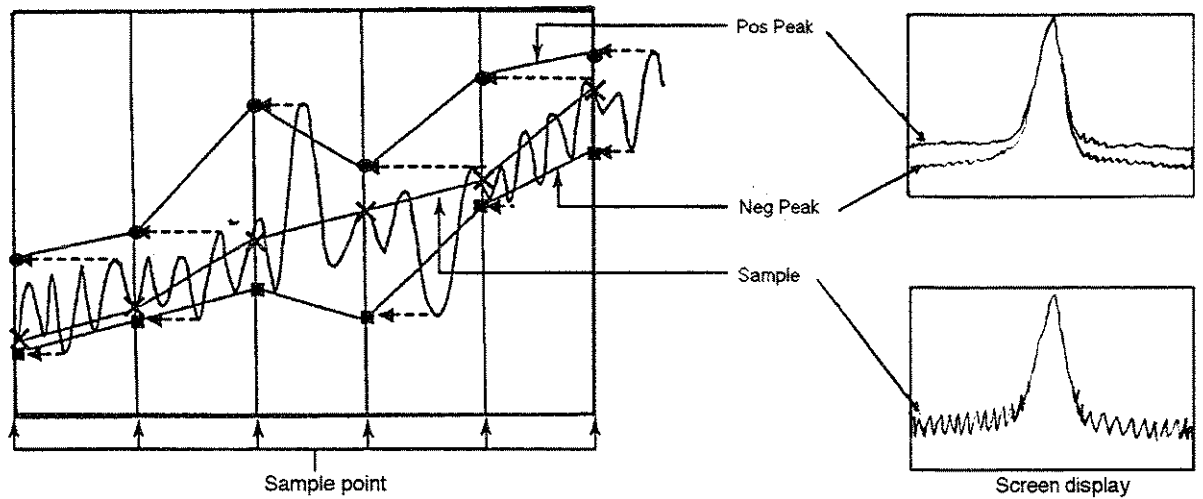

Note: When the detection mode is set to Sample or Neg Peak while the frequency span and resolution bandwidth are set so that the spectrum is displayed as discrete vertical lines, the spectrum peak is incorrectly displayed.

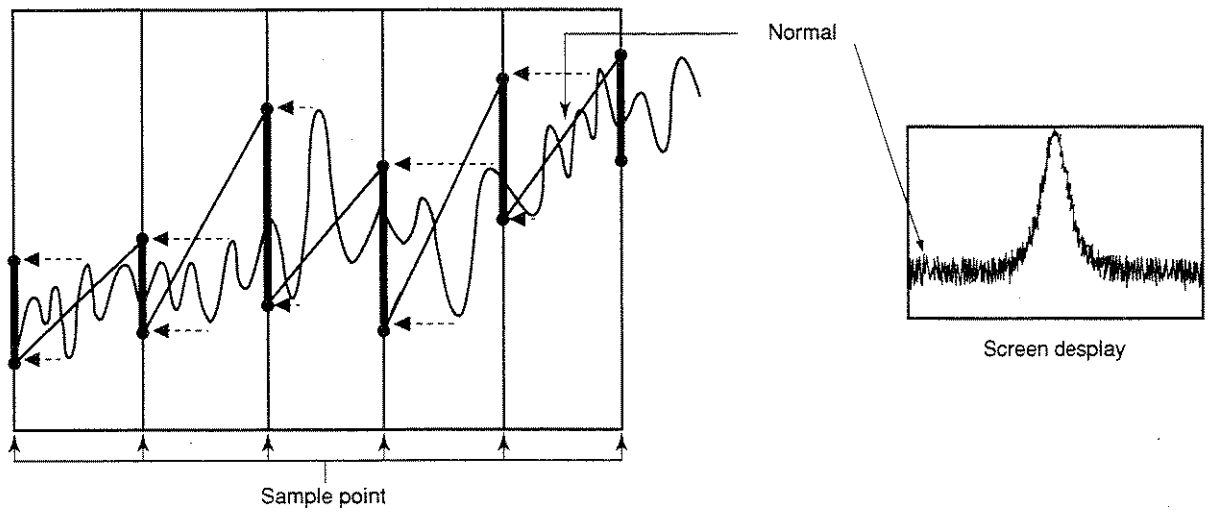

Normal traces and displays both Pos Peak and Neg Peak.



## Time Domain

Since the spectrum analyzer stops sweeping the frequency when set to a frequency span of 0 Hz, the spectrum analyzer becomes a selective level meter that continues to receive only the center frequency. In this case, the horizontal axis of the time-axis sweep waveform is graduated in time and displayed on the spectrum analyzer screen. This display method is called "time domain display".

The spectrum analyzer time domain display has an Expand function for expanding the waveform time axis to create a more convenient display. It also has a special function for monitoring an FM demodulated waveform.

## Setting Time Domain

The time domain can normally be set by pressing the **Time** key in the Display section. It can also be set by setting the frequency span to 0 Hz in the frequency domain mode.

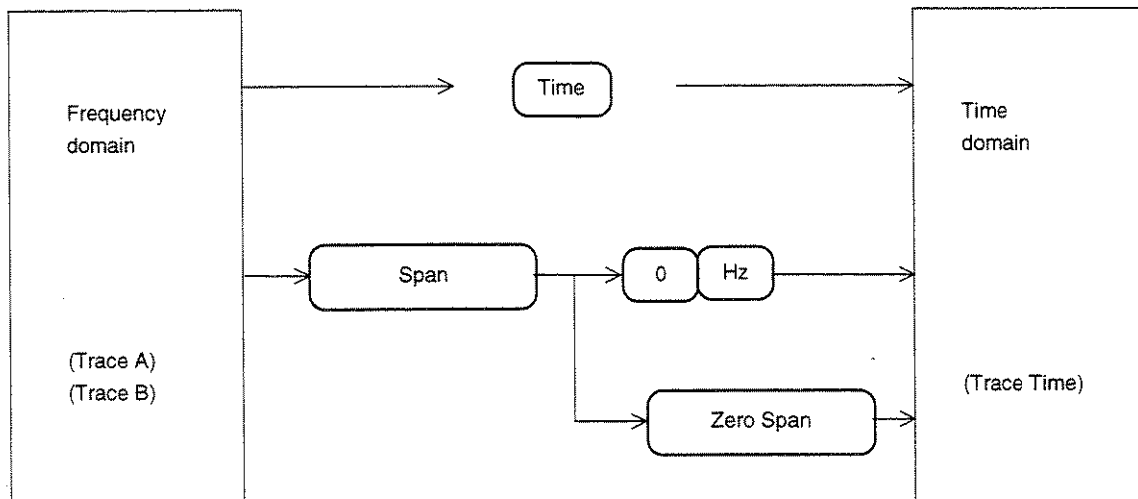

The following parameters can be set independently in the frequency domain or time domain mode.

- Vertical scale mode (Log/Lin)
- Vertical scale range (10 dB/div, 10%/div, etc.)
- Storage mode (Normal, Max Hold, Average, etc.)
- Detection mode (Pos Peak, Sample, Neg Peak, Normal)
- Resolution bandwidth (RBW)
- Video bandwidth (VBW)
- Sweep time (Sweep Time/Time Span)
- Trigger switch (Freerun/Triggered)

The three parameters resolution bandwidth, video bandwidth, and sweep time can be selected in common or independently in the frequency domain or time domain mode when setting the system.

Note: The time domain mode marker function uses a spot marker. A zone marker cannot be used.

## Setting Time Span

In the time domain mode, the measurement range on the horizontal axis does not set the frequency span, but sets the time span. To set the time span, perform the following key operations.

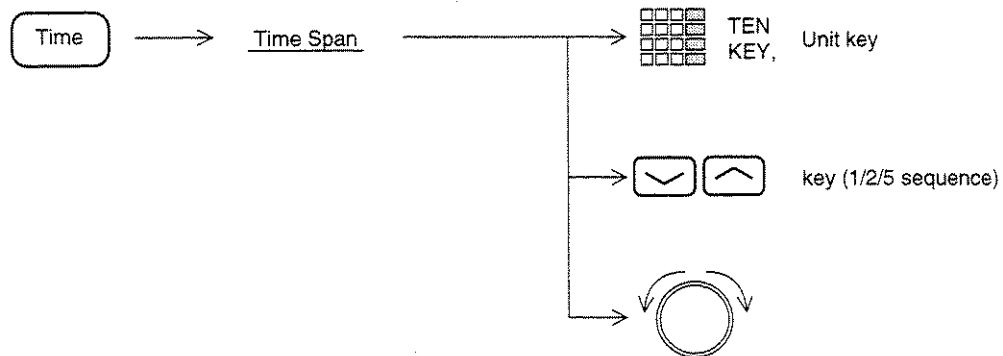

# Time Domain Expanded Display

Part of the time domain time axis can be expanded and displayed.

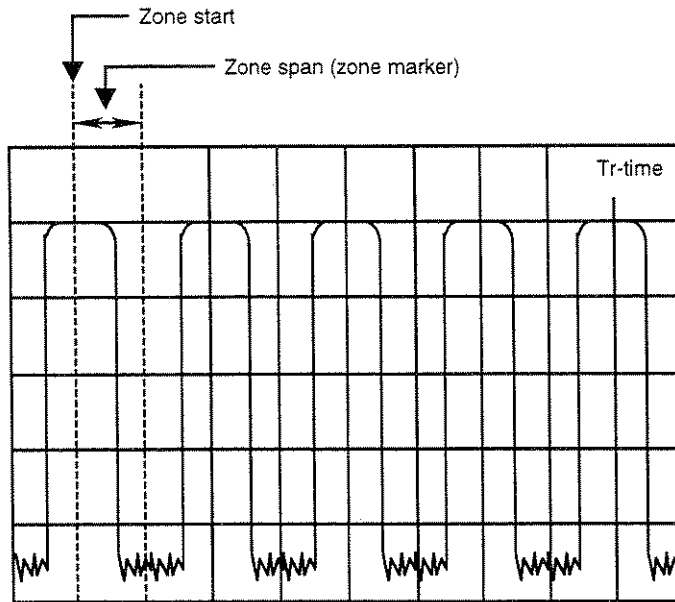
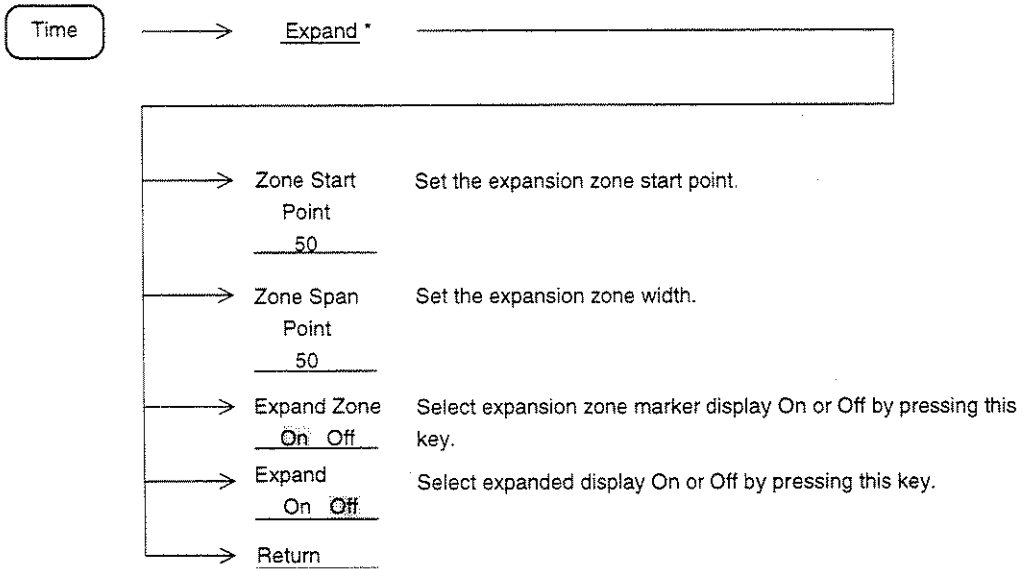

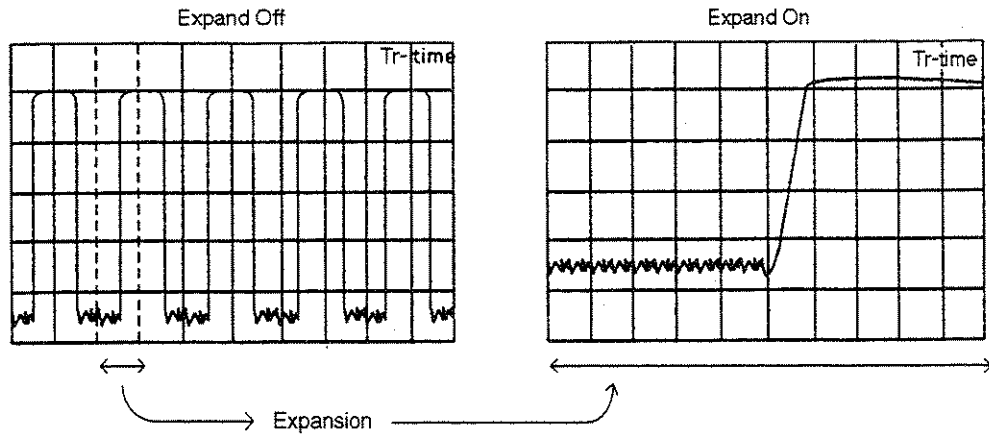

The Expand mode cannot be executed under the following conditions.

- Trigger mode ..... Freerun

## Monitoring FM Demodulated Waveforms

The spectrum analyzer contains an FM demodulator (Opt.05 FM demodulation waveform monitor) to display demodulated waveforms.

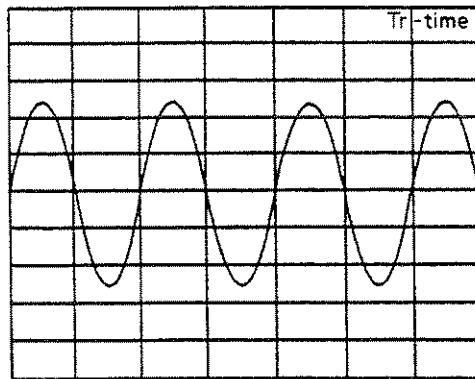
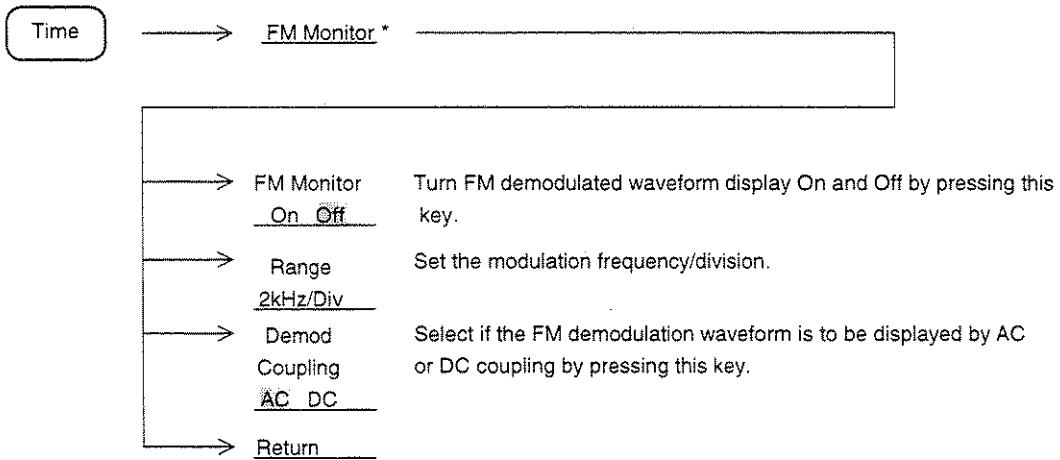

By using the FM demodulated waveform monitor function, frequency deviation can be easily measured.

To monitor an FM demodulated waveform, set the resolution bandwidth and video bandwidth as follows:

- Resolution bandwidth (RBW) ..... When a signal not accompanied by an interference wave has been received, the resolution bandwidth should be made as wide as possible. If it is necessary to narrow the resolution bandwidth, the bandwidth should be made more than three times (frequency deviation + modulation frequency). Too narrow a resolution bandwidth results in a distorted modulation waveform.
- Video bandwidth (VBW) ..... The video bandwidth should be made as narrow as possible although a bandwidth of more than ten times the modulation frequency is required. Setting a wide video bandwidth will degrade the S/N ratio. If it is necessary to set a wide bandwidth, digital averaging can be used to improve the S/N ratio.

**Note:** • Because the demodulation frequency range depends on the FM demodulation range, if the FM demodulation range is switched to an FM signal with a high demodulation frequency, a different waveform will be observed.

The following shows the demodulation frequency range corresponding to the respective FM demodulation ranges.

50, 100, 200 kHz/div range	DC or 50 Hz to 500 kHz
2, 5, 10, 20 kHz/div range	DC or 50 Hz to 50 kHz

- Usable RBW
  - For MS2651B/2661B/2653B/2663B: RBW  $\geq$  100 kHz
  - For MS2661C/2663C: RBW  $\geq$  1 kHz

## SECTION 6

### SELECTING THE SWEEP METHOD

This section describes the sweep mode, trigger sweep mode, zone sweep, and signal tracking and time gate functions.

#### TABLE OF CONTENTS

Sweep Mode .....	6-3
Continuous Sweep Mode .....	6-3
Single Sweep Mode .....	6-4
Trigger Mode .....	6-5
Freerun .....	6-5
Triggered .....	6-6
Video Trigger .....	6-7
Wide IF Video Trigger .....	6-8
External Trigger .....	6-8
TV Trigger .....	6-9
Line Trigger .....	6-10
Delay Time .....	6-10
Zone Sweep and Signal Tracking .....	6-12
Zone Sweep .....	6-12
Signal Tracking .....	6-13
Time Gate Function .....	6-14
Creating a Gate Control Signal .....	6-17
Setting Gate Function .....	6-18
Domain Sweep .....	6-22
Using Domain Sweep .....	6-22

# SECTION 6 SELECTING THE SWEEP METHOD

## Sweep Mode

The spectrum analyzer sweep mode is set by using the following key.

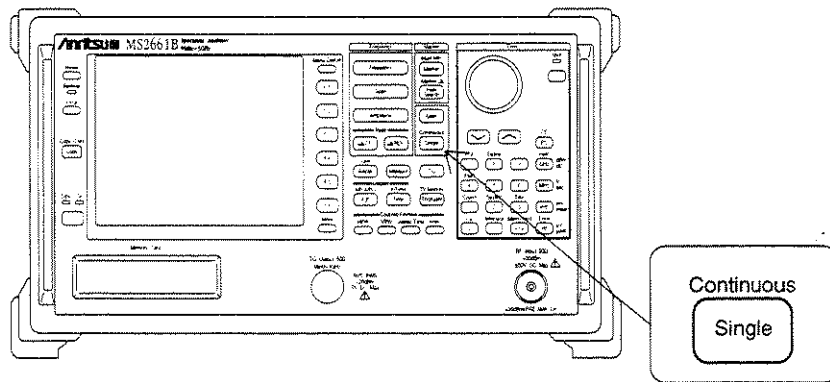

## Continuous Sweep Mode

When the trigger mode is set to Freerun, sweep is performed continuously. When the trigger mode is set to Triggered, sweep is executed each time the trigger conditions are met.

To set the continuous sweep mode, perform the following key operation. (The continuous sweep mode is initially set.)





# Single Sweep Mode

When the trigger mode is set to Freerun, sweep is executed once immediately after the <sup>Continuous</sup> Single key is pressed.

When the trigger mode is set to Triggered, sweep is executed only once when the trigger conditions are met after the <sup>Continuous</sup> Single key is pressed.

To set (sweep start) the single sweep mode, operate the following key.



## Trigger Mode

The spectrum analyzer trigger mode can be divided into Freerun and Triggered.

In the Triggered mode, Video, Wide IF Video, External, TV, or Line can be selected as the trigger source.

To use the Trigger mode, Option 06 Trigger/gate circuit is required.

## Freerun

When the sweep mode is set to continuous, sweep is repeated continuously. When the sweep mode is set to single sweep, sweep is started immediately after the <sup>Continuous</sup> Single key is pressed.

To set the Freerun mode, perform the following key operations. (The Freerun mode is initially set.)

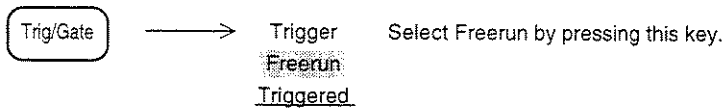

# Triggered

When the conditions of the pre-selected trigger source are met, sweep is started.

To set the Triggered mode and to select the trigger source, perform the following key operations.

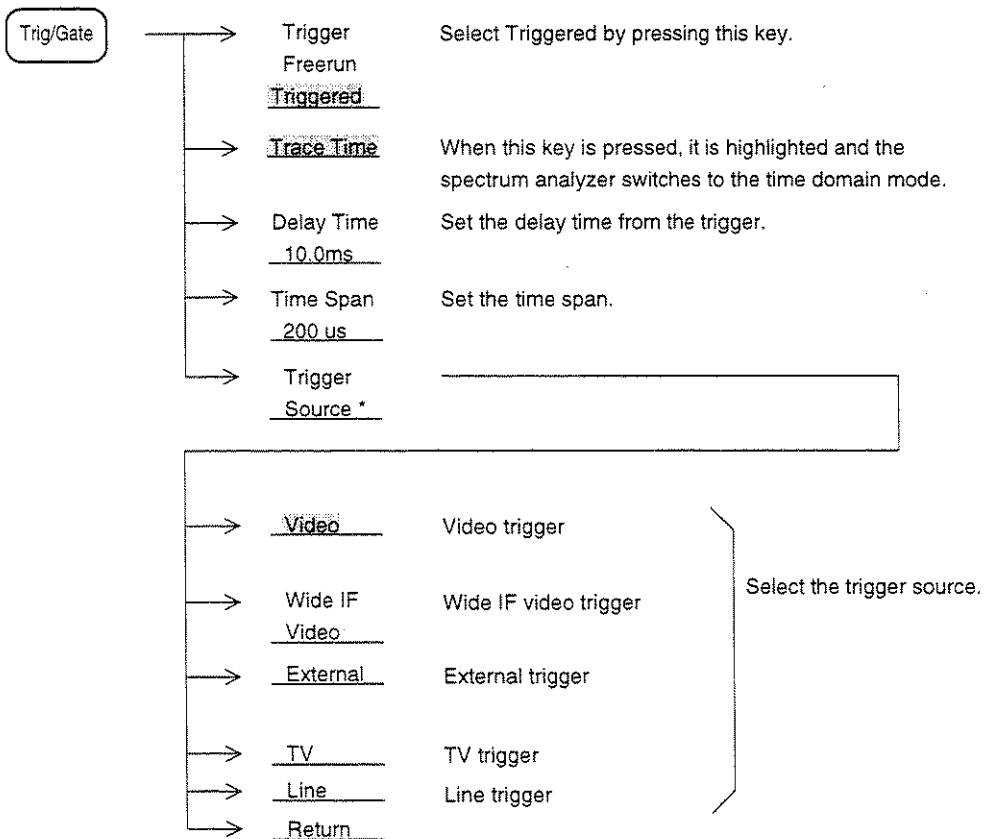

# Video Trigger

Sweep is started in synchronization with the positive leading edge or negative leading edge of the detected waveform.

To select the trigger level and trigger slope, perform the following key operations.

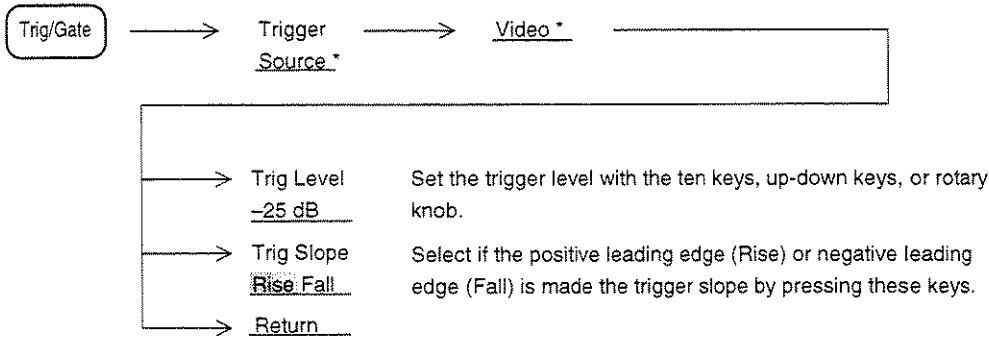

The trigger level is indicated by displaying the trigger level indicator ▶ at the leftmost vertical line of the screen.

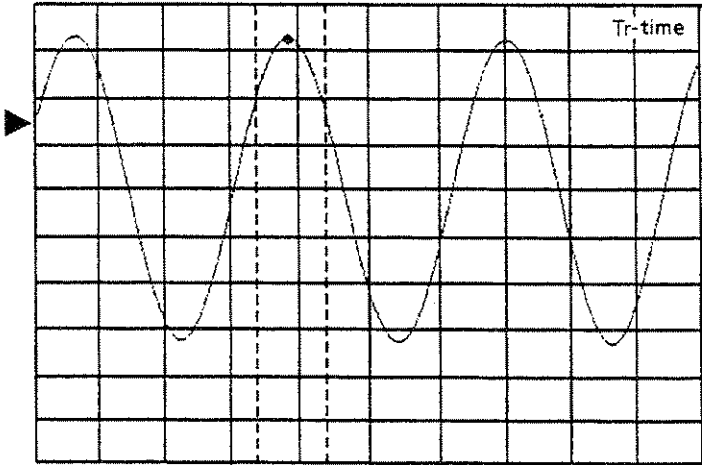

## Wide IF Video Trigger

A wide bandwidth IF signal of at least 5 MHz is detected and sweep is started in synchronization with its positive leading edge or negative leading edge.

To select the trigger level and trigger slope, perform the following key operations.

Generally, there is no burst synchronizing signal and this signal is used as a burst wave gate control signal.

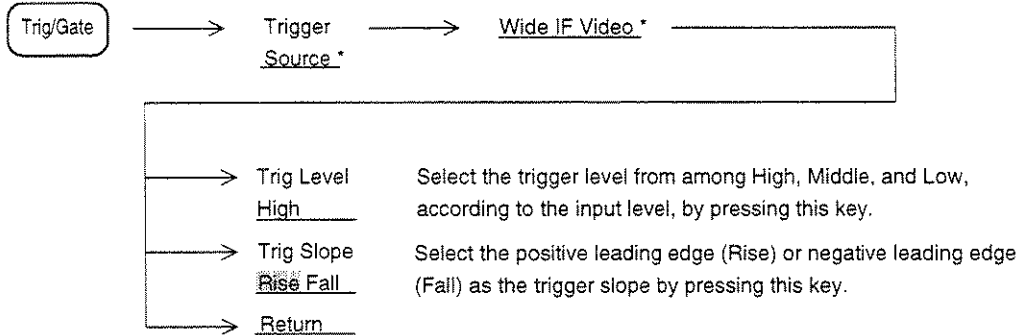

An indicator of appropriate trigger levels for Wide IF Video is listed below.

Trig Level	Mixer level*
High	-10 dBm(nominal)
Middle	-20 dBm(nominal)
Low	-30 dBm(nominal)

\* This designed at 100 MHz.

Actual trig level is dependent of frequency of input.

Mixer level is "actual input of RF input" - " RF attenuator value ", if the instrument has no preamplifier option installed.

## External Trigger

Sweep is started in synchronization with the positive leading edge or negative leading edge of the signal waveform input to the Ext Input connector on the rear panel. To select the trigger level and trigger slope, perform the following key operations.

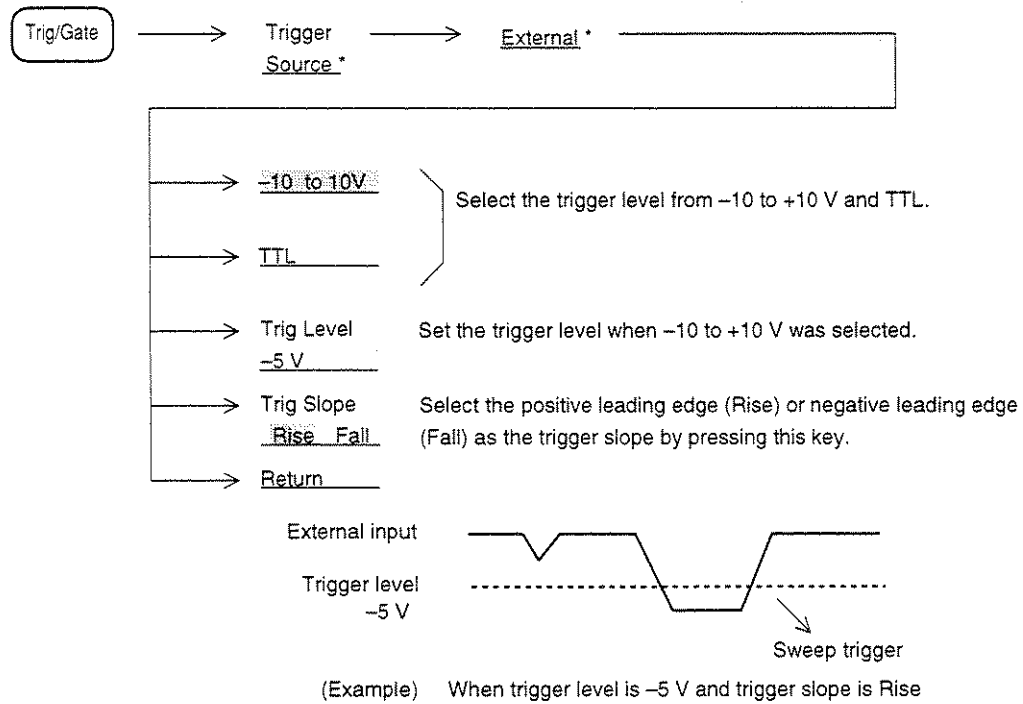

## TV Trigger

This function detects the horizontal or vertical synchronizing signal of the TV signal and uses it to start sweep. It is an Option function.

To use the TV trigger function, Option 06 Trigger/gate sweep and Option 16 TV image monitor are required.

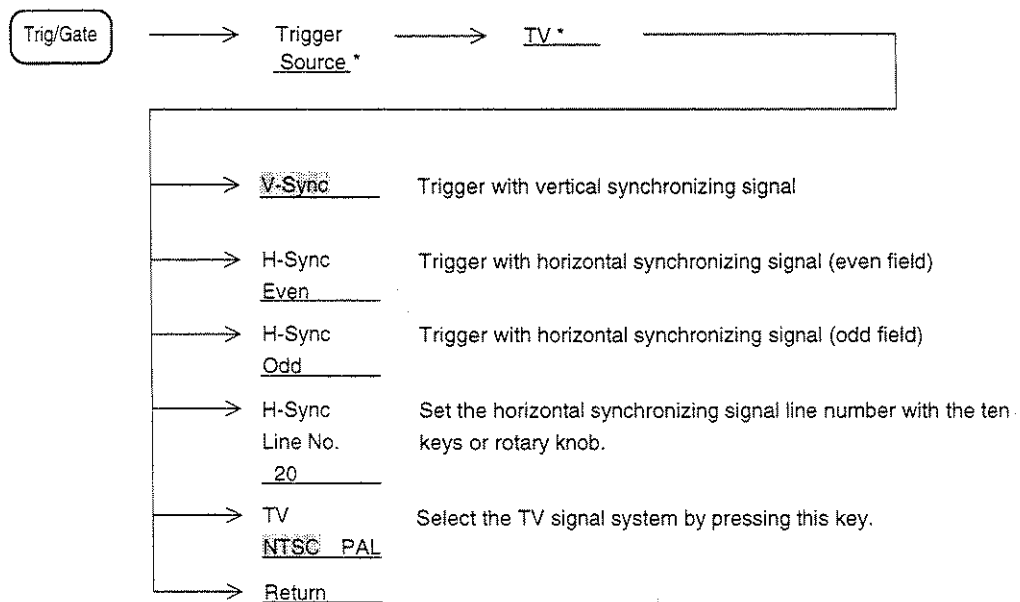

Note: TV trigger operates normally under the following conditions:

- Trace Time
- The peak level of the signal level exceeds 50% of the reference level.

## Line Trigger

This function starts sweep in synchronization with the AC power line frequency. Line trigger is conveniently used to observe power line-related hum waveform. With the line trigger function, the trigger level and trigger slope are not selected.

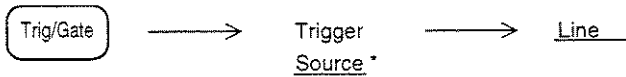

## Delay Time

When the trigger mode is set to Triggered in the time domain mode, the trigger point is usually positioned at the left end of the screen. This, however, means that it is not possible to see the waveform before the trigger point and the waveform beyond the right end of the screen.

With the spectrum analyzer, a waveform away from the trigger point can be displayed by changing the delay time.

To set the delay time, perform the following key operations.

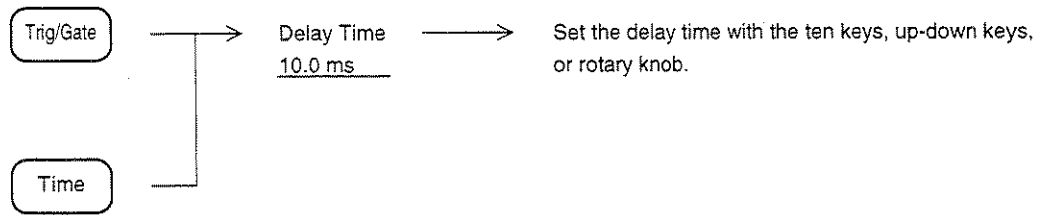

If the trigger point on the time axis on the screen was set by delay time, the trigger level indicator ► is displayed at the bottom of the screen.

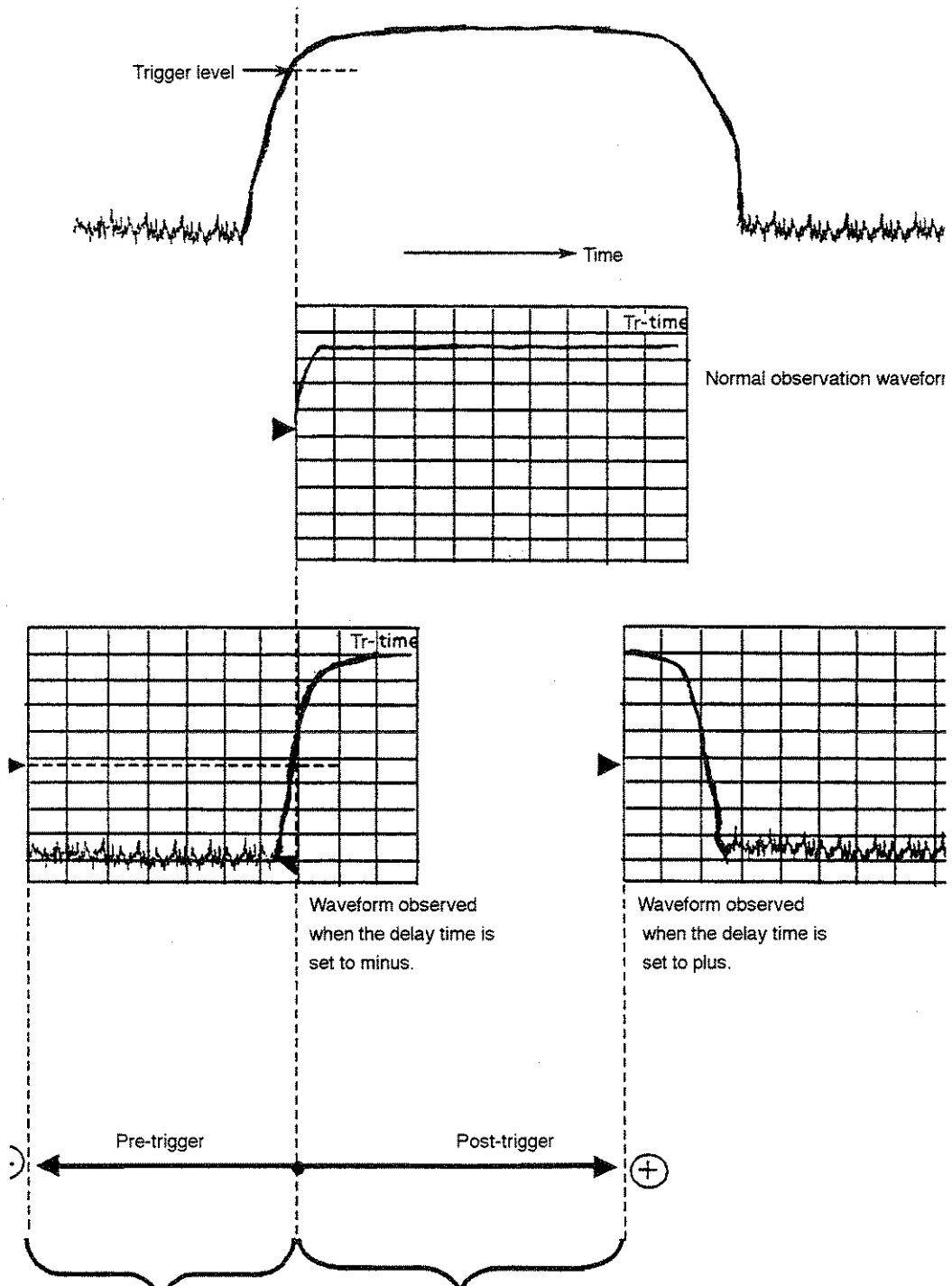

Example of Waveform With Delay Time (when used with video trigger)



## Zone Sweep and Signal Tracking

The spectrum analyzer has two sweep methods - zone sweep which sweeps only within the zone marker and a signal tracking function which detects the peak level frequency at each sweep, then moves it to the center of the zone marker.

### Zone Sweep

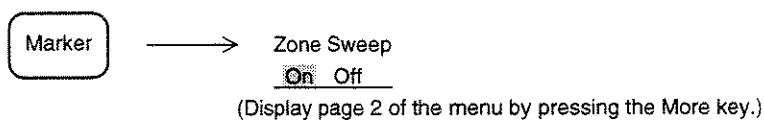

Zone sweep can be conveniently used to closely and quickly analyze part of the whole sweep range on the screen.

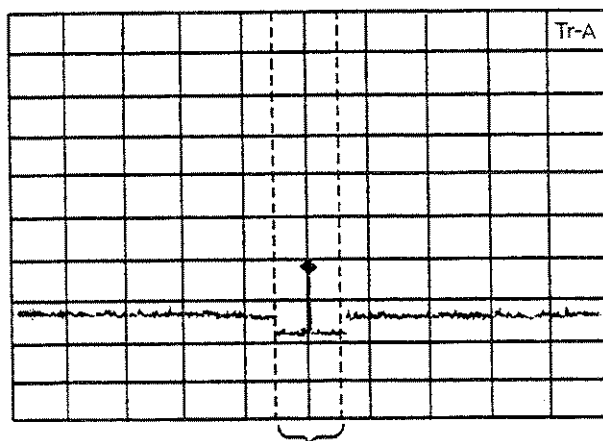

A signal masked by noise can be analyzed at high speed by setting zone sweep to On and adjusting the resolution bandwidth and video bandwidth.

**Note:** Zone sweep cannot be executed while the marker is Off or when the instrument is in the time domain mode.

When the multimarker function is on, Each multimarker in on state is sequentially zone-swept(multi-zone sweep).

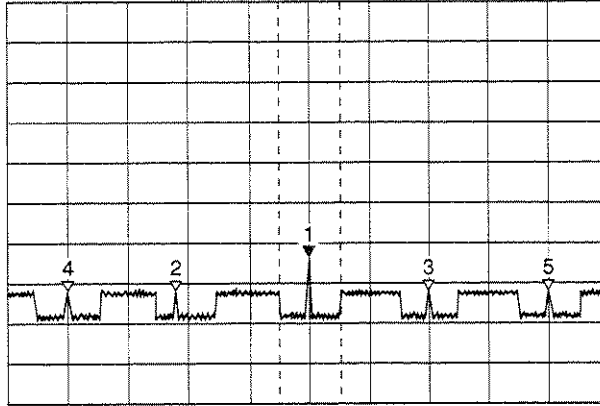

## Signal Tracking

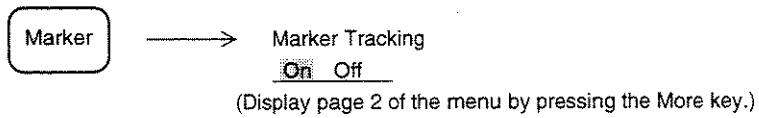

The signal tracking function moves the frequency of the signal of the peak level in the zone marker to the center of the zone marker at each sweep. This is convenient when tracking and analyzing a signal whose frequency drifts.

**Note:** The signal tracking function cannot be executed while the marker is Off or when the instrument is in the time domain mode.

## Time Gate Function

The time gate function is a sweep mode which turns the waveform data display On and Off by the gate control signal generated in the spectrum analyzer based on an external signal or video trigger signal.

Since the timing that displays the spectrum waveform can be set by using this mode, the spectrum when the burst signal is On can be analyzed.

In order to use the time gate function, an external trigger signal synchronized with burst wave On/Off or other signal change is required to create the gate control signal.

When an external synchronizing signal is unavailable, set the trigger source to wide IF video trigger. A synchronizing signal can be obtained internally.

Burst wave input signal

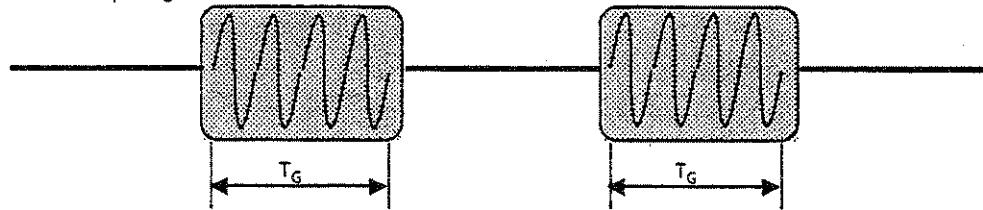

If the spectrum of the burst wave above is analyzed as it is,

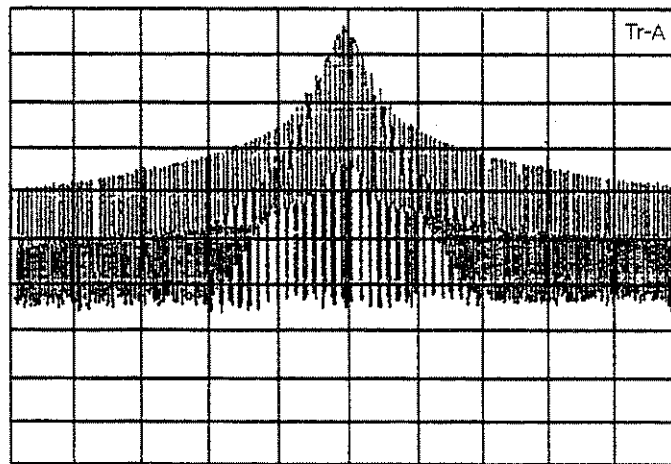

The spectrum spread by the positive leading edge or negative leading edge of the burst wave prevents the spectrum from being observed with the burst set to On.

If the spectrum can be analyzed only during the gate time  $T_G$ ,

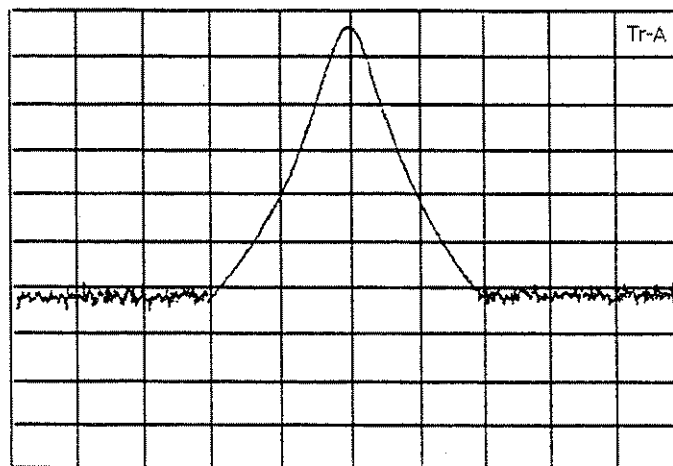

Only the spectrum when the burst is set to On is displayed.

When the time gate function is executed, sweep runs in the Freerun mode and only the waveform data validated by the gate control signal is refreshed. If the sweep period is not synchronized with the gate control signal, a perfectly shaped trace can be obtained by increasing the number of sweep repetitions.

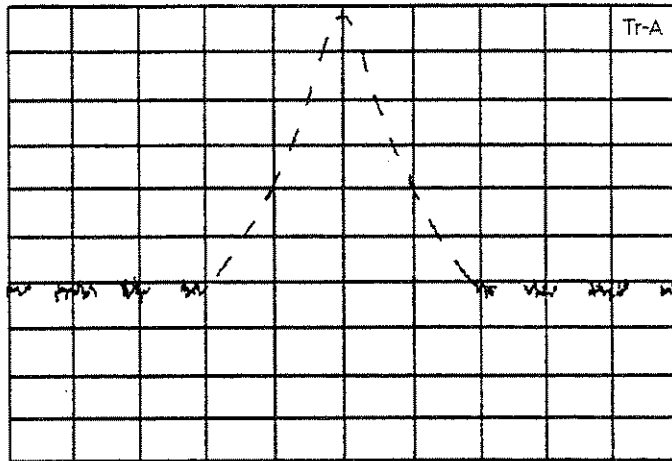

Fewer Sweep Repetitions

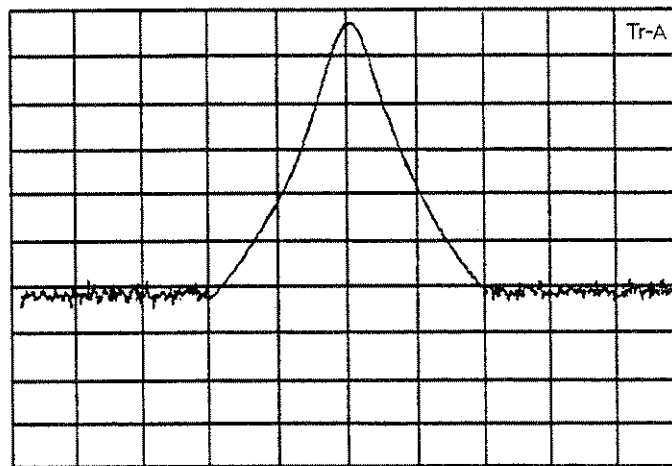

More Sweep Repetitions

Example of Frequency Spectrum Measurement on Burst Signal

## Creating a Gate Control Signal

If the point where an external trigger signal (Ext Input only) or a wide IF video trigger signal is triggered is assumed to be the reference position, the gate control signal remains On over the period from the point immediately after the Gate Delay time has elapsed from the reference position to the time set by Gate Length, or to the time reset by a trigger signal.

- Gate End: When Int selected

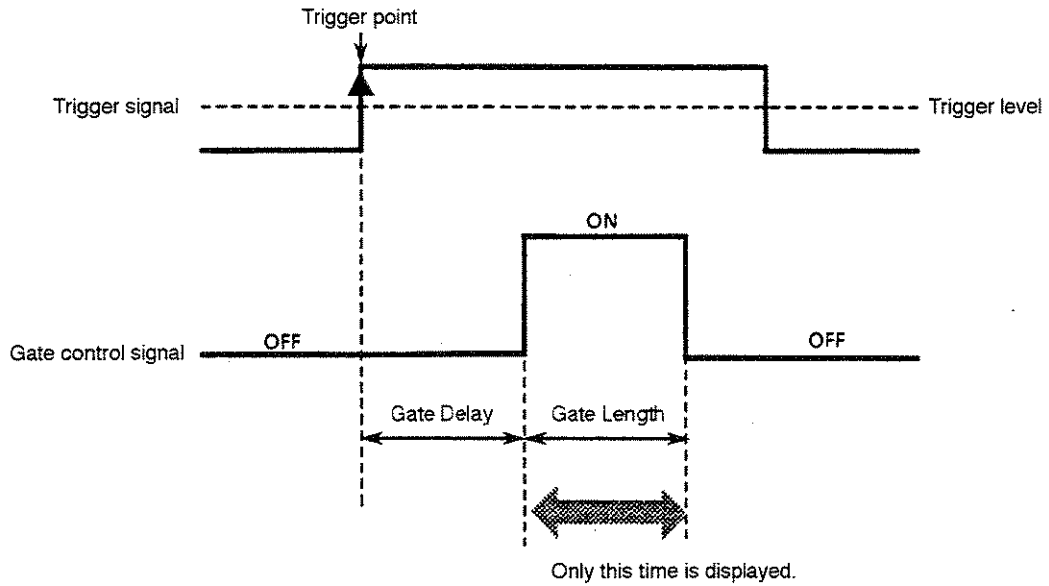

- Gate End: When Ext selected

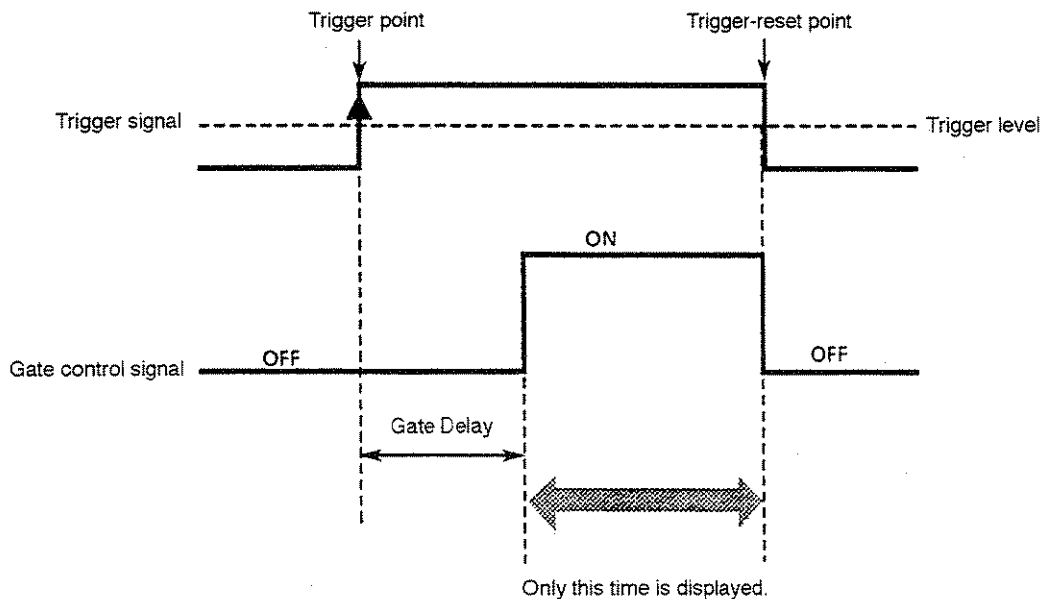

To turn the gate time analysis function On and Off and to create the gate control signal, perform the following key operations.

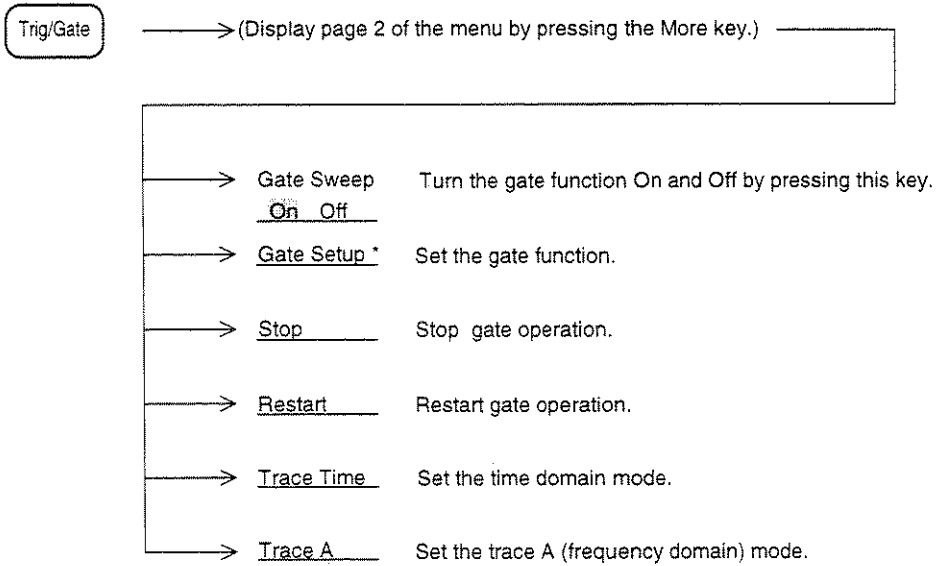

## Setting Gate Function

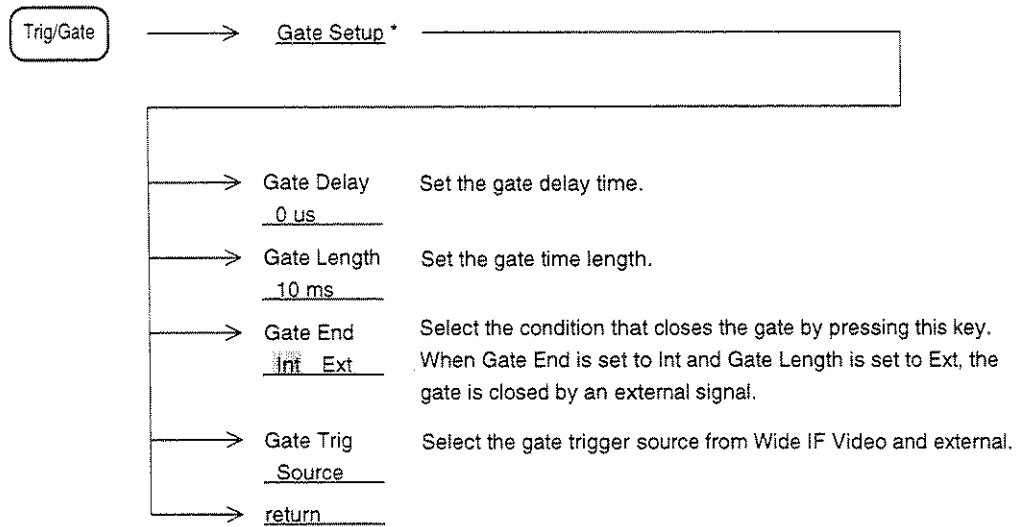

The time domain mode facilitates setting the gate control signal time. The following shows an example of how to use the Time Gate function that uses the time domain mode.

Step	Procedure
1	Input the following signals to the spectrum analyzer.

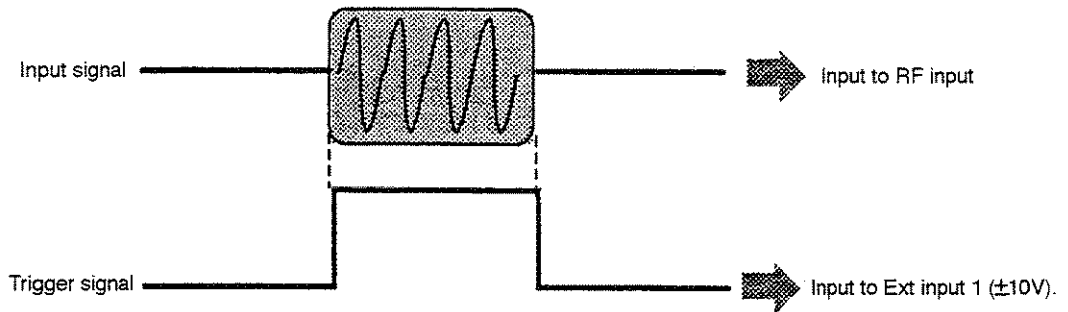

- 2 Display the waveform in the time domain mode. Synchronize the input signal by setting the trigger mode to Triggered and the trigger source to Ext Input 1 (–10 to 10V).

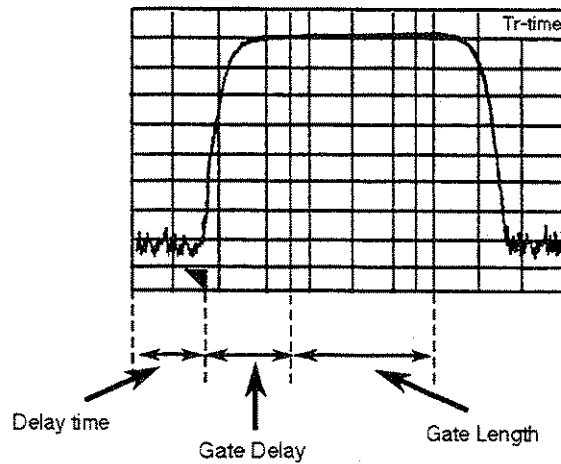

- 3 Set Gate to On. Vertical lines (gate cursor) should appear at the Gate Delay and Gate Length positions. Set Gate Delay and Gate Length to appropriate positions while observing the waveform.
- At this time, adjust the resolution bandwidth and video bandwidth in the time domain mode to equal those in the frequency domain mode, then set the gate cursor positions. The influence of spike-like noises independent of the conditions shown in Note ① described later can be avoided.



Step	Procedure
4	Set the frequency domain mode. The trigger mode becomes Freerun and the waveform data is displayed only for the time set by Gate Length.

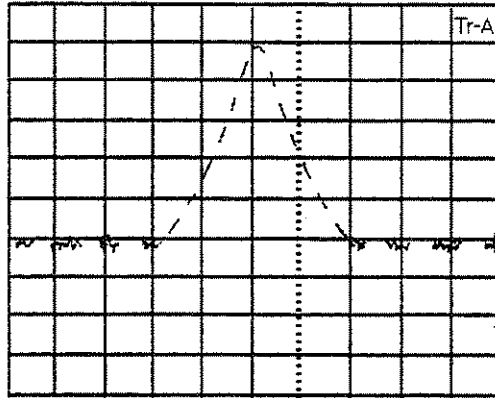

Notes: ① The detector output is delayed compared to the positive leading edge of the input waveform when the resolution bandwidth (RBW) is narrowed in the frequency domain measurement mode. As a result, spike-like noises may appear on the trace. To prevent this from appearing, set Gate Delay and Gate Length to values that satisfy the following conditions.

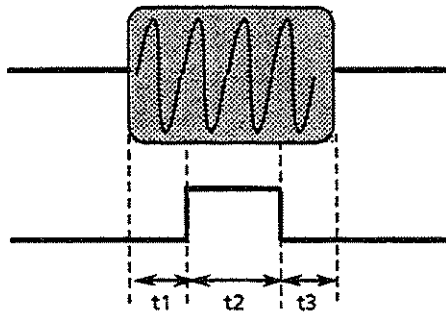

RBW	t1	t2	t3
1 kHz	$\geq 3 \text{ ms}$	$\geq 20 \mu\text{s}$	$\geq 1 \mu\text{s}$
3 kHz	$\geq 1 \text{ ms}$		
10 kHz	$\geq 230 \mu\text{s}$		
30 kHz	$\geq 200 \mu\text{s}$		
100 kHz	$\geq 20 \mu\text{s}$		
300 kHz	$\geq 15 \mu\text{s}$		
1 MHz	$\geq 10 \mu\text{s}$		
5 MHz			

- ② When the resolution bandwidth (RBW) is extremely narrow for the frequency span, some waveforms cannot be displayed correctly. Set each parameter so that the following conditions are satisfied.

$$\text{RBW} \geq \frac{\text{Span}}{\text{Number of data points (501)}} \times 5$$

- ③ The Time Gate function can use a video trigger as the gate control signal. In this case, the gate control signal must be generated correctly so that a trigger can be normally set with the same RBW, VBW, and trigger level conditions at all frequencies within the frequency span observed in the frequency domain. (See the figure below.)

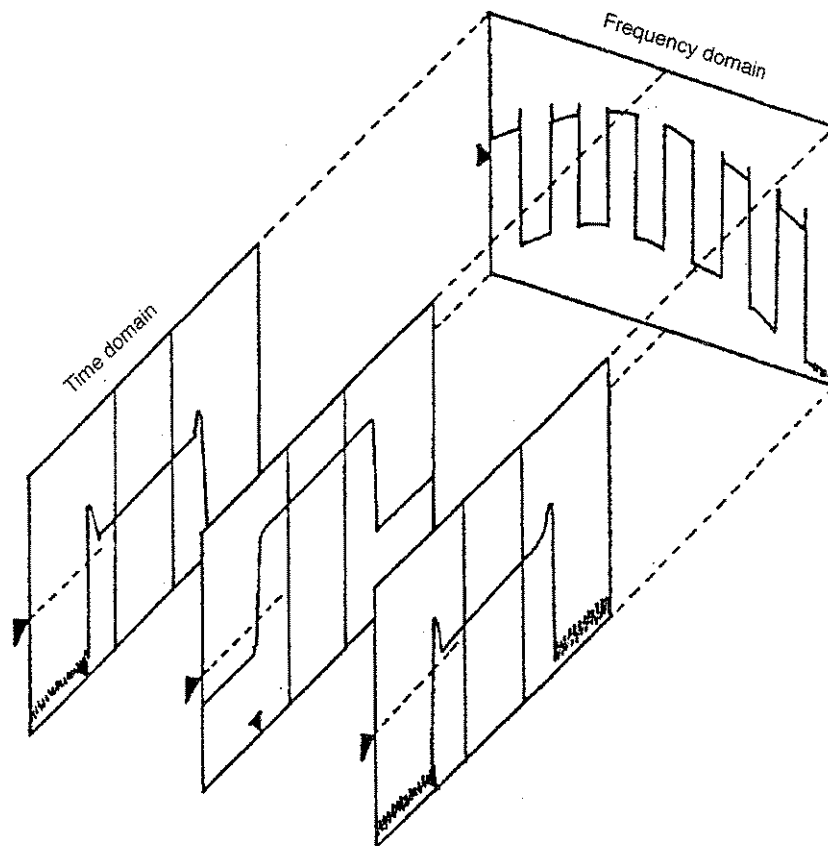

Trigger can be applied by the gate control signal created internally by setting the trigger source to Wide IF Video.

## Domain Sweep

In conducting a sweep by traces A and B (frequency axes), a sweep operation consists of the procedures: setting a center frequency in each sweep, and moving observation frequency. (Lock and Roll)

When "Domain Sweep" function is selected, the frequency setting is done only once in a specified number(Domain count) of sweep operations, and the rest of the sweep operations are performed without this setting.

When the frequency setting is performed, it is necessary to wait for the frequency to stabilize before a sweep can be started. By using "Domain Sweep" function, the time required for frequency to stabilize is saved, and the sweep repetition cycle can be shortened.

- Note:*
- When using "Domain Sweep" function, the specifications on frequency such as frequency stability and frequency indicating determinacy are no longer assured.
  - Selecting "storage mode=Max hold/Min hold/Average" in using "Domain Sweep" function, may result in making the errors between measured levels large. When using "Domain Sweep" function, it is suggested to select "storage mode=Normal".
  - When a certain sweep duration or frequency span is set, sweep repetition cycle may not be shortened even though using "Domain Sweep" function.

## Using Domain Sweep

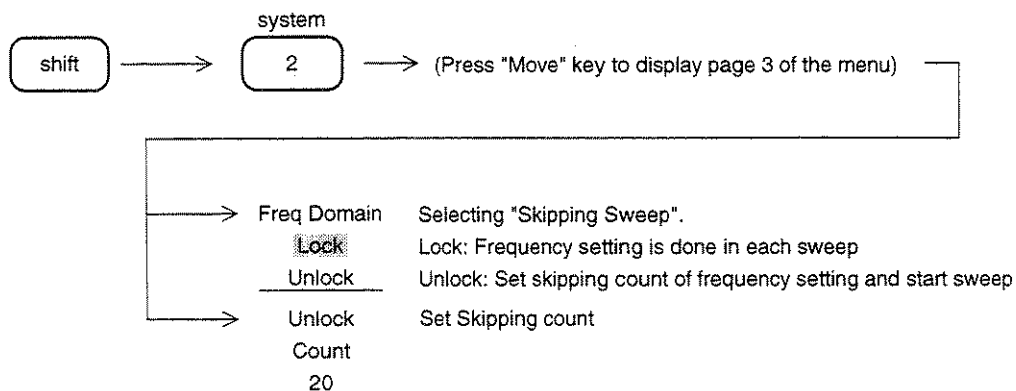

# SECTION 7

## COUPLED FUNCTION

This section describes the coupled function. Generally, the spectrum analyzer automatically selects the optimum values of the coupled function so that both the correct level and correct frequency values can be measured.

This is called the Auto Coupled Function.

This section mainly describes manual settings that are used to set the coupled function according to the application.

### TABLE OF CONTENTS

From Auto to Manual Operation .....	7-4
Resolution Bandwidth (RBW) and Sweep Time .....	7-4
Video Bandwidth (VBW) .....	7-7
Input Attenuator (Atten) .....	7-8

# SECTION 7 COUPLED FUNCTION

The coupled function of the four functions Resolution Bandwidth (RBW), Video Bandwidth (VBW), Sweep Time, and Attenuation (Atten) is initially set to Auto so that the spectrum analyzer can automatically select the optimum setting.

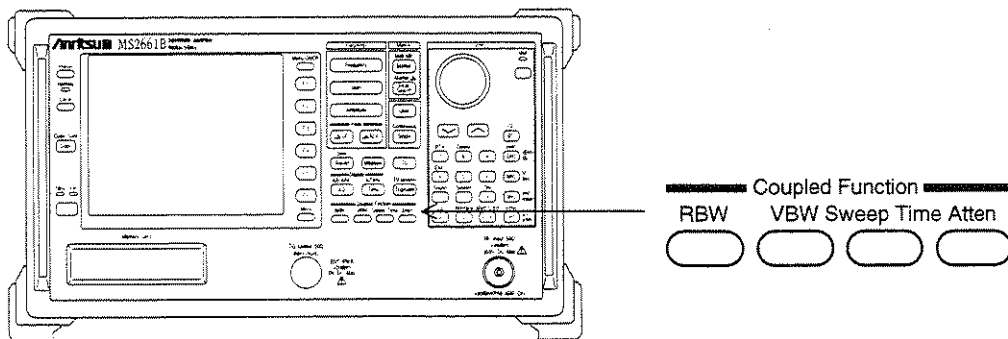

## From Auto to Manual Operation

Perform manual setting as follows:

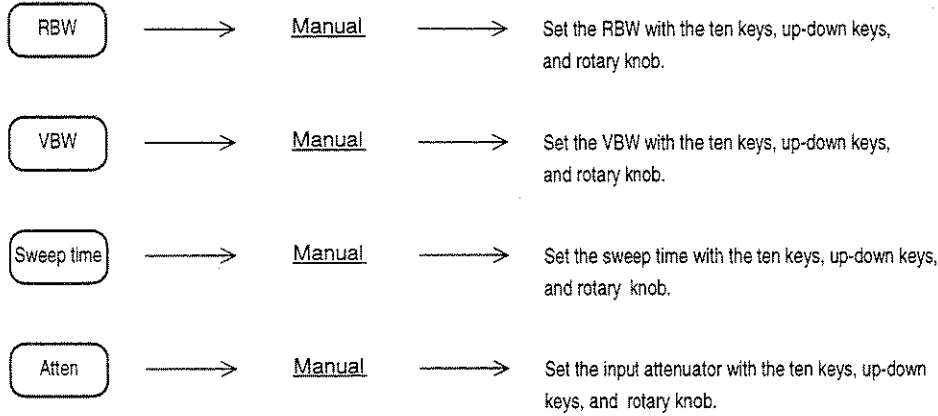

## Resolution Bandwidth (RBW) and Sweep Time

To set the RBW and Sweep Time, perform the following key operations.

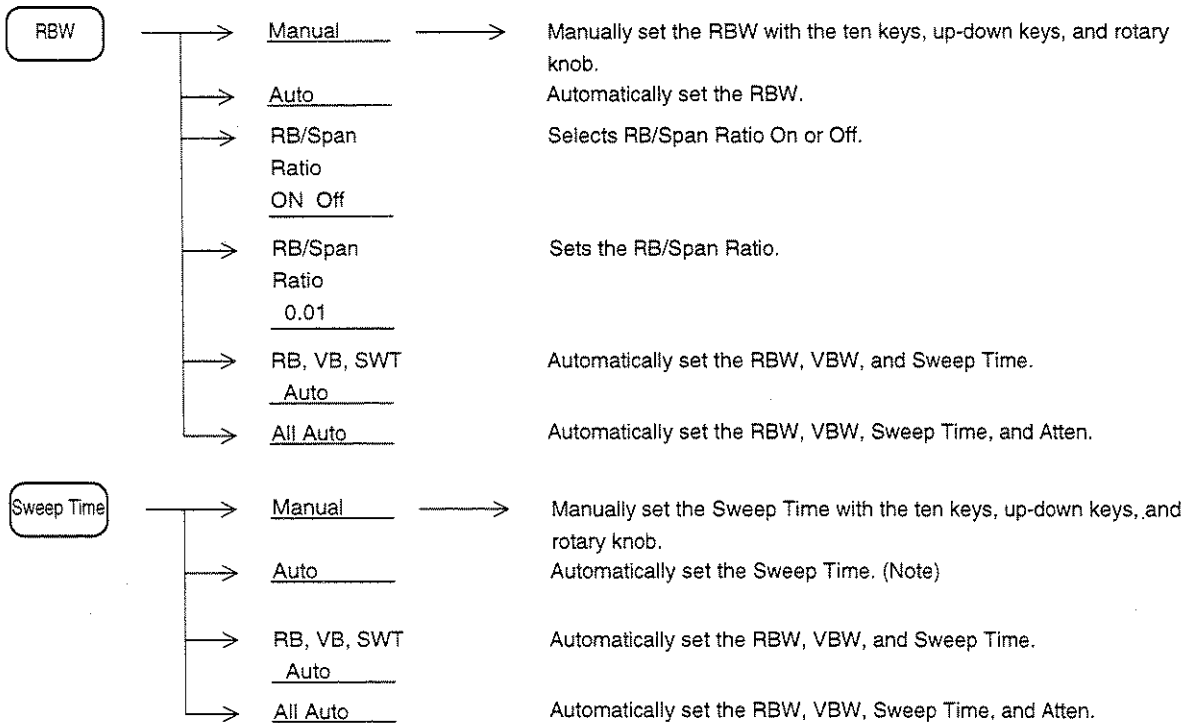

Note: Either of the two automatic set modes (Auto SWT: Hi-Lvl-Acc and Fast) can be selected. Normally, select the Hi-Lvl-Acc mode. See Section 9 for details.

## (1) Auto mode

The RBW, Sweep Time, and VBW parameters are set to Auto so that even if the frequency span is varied, the respective parameters are automatically set to the optimum values so that frequency and level measurement errors do not occur.

The following shows the Swp Time Auto setting range:

- Lower limit value  
20 msec
- Upper limit value  
1000 sec

## (2) Manual setting

If RBW, VBW, and Sweep Time are set to the Auto mode, normal measurements can be made without considering their settings.

However, in the following cases, RBW should be set to the Manual mode.

**General measurements:** When observing two adjacent signals, increasing the frequency resolution by narrowing the RBW can reduce the noise level (a tenth part of the current RBW results in a 10 dB reduction).

However, if the RBW is too narrow, the spectrum waveforms will become too steep, the response characteristics become worse, and the sweep time will also become longer. Therefore, the RBW value should be determined to give a practical sweep speed.

**Intermodulation distortion measurement:** When measuring two signal intermodulation distortion with a comparatively wide frequency span and a reduced noise level, the RBW value should be narrowed by manual setting. However, the sweep time increases in inverse proportion to the square of the RBW.

The RBW can be selected from among the following by Manual setting:

- MS2651B/2661B/2653B/2663B  
1 kHz, 3 kHz, 10 kHz, 30 kHz, 100 kHz, 300 kHz, 1 MHz, 5 MHz
- MS2661C/2663C  
1 kHz, 3 kHz, 10 kHz, 30 kHz, 100 kHz, 300 kHz, 1 MHz, 3 MHz
- 30 Hz, 100 Hz, 300 Hz (Option 02 Narrow RBW is required.)

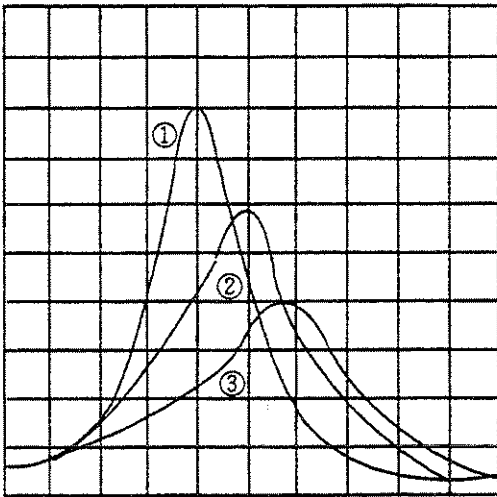

- ① Optimum trace waveform
- ②, ③ UNCAL trace waveforms

**Note:** The spectrum traces on the screen are displayed as shown at the left according to the sweep time. The optimum sweep time gives a waveform like ①. However, a sweep time that is too fast decreases the waveform amplitude on the display as shown in ② and ③. Therefore, the apparent bandwidth gets wider, and the frequency also shifts. When waveform ① cannot be maintained, "UNCAL" is displayed.



## Video Bandwidth (VBW)

To set the VBW, perform the following key operations.

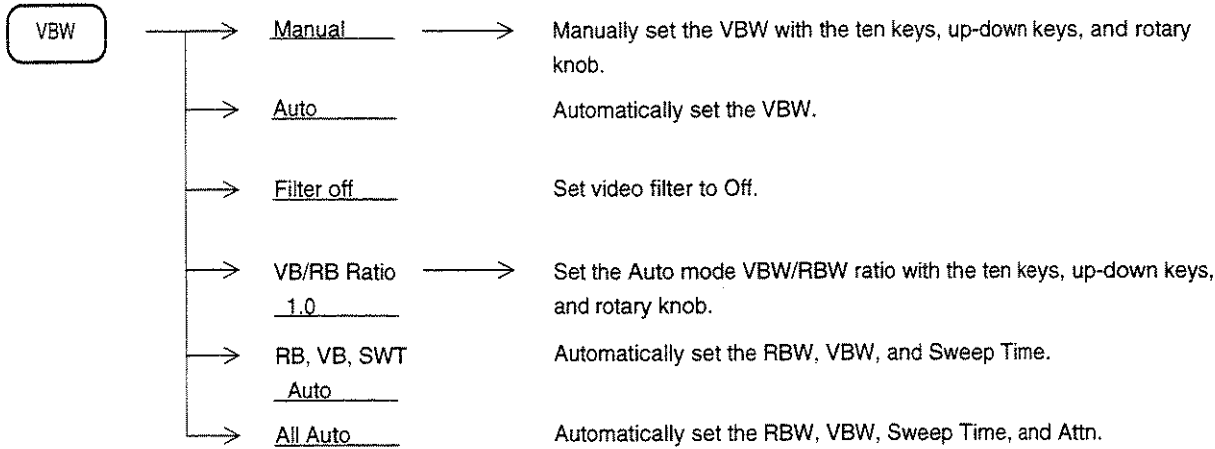

### (1) Auto mode

When VBW is set to Auto, the product of the RBW set value multiplied by the VB/RB Ratio is set. Since VB/RB Ratio is initially set to 1, RBW and VBW are set to the same value.

By setting the VB/RB Ratio to a small value, since VBW is set to a narrow value according to the RBW setting, noise can be efficiently averaged.

**Note:** Since the VBW setting range is 1 Hz to 3 MHz, if an attempt is made to exceed this range, the VBW is set to 1 Hz or 3 MHz.

### (2) Manual setting

When wanting to average the noise by making the VBW narrow without regard to the RBW set value, or when wanting to make the VBW wide to observe the waveform of signals modulated at a high frequency, use Manual setting.

The VBW value can be manually set from among the following values:

1 Hz, 3 Hz, 10 Hz, 30 Hz, 100 Hz, 300 Hz, 1 kHz, 3 kHz, 10 kHz, 30 kHz, 100 kHz, 300 kHz, 1 MHz, 3 MHz, OFF

**Note:**

- When  $\text{VBW} \geq \text{RBW}$  is set, noise is not averaged and the sweep speed is increased.
- Noise can also be averaged without narrowing the VBW (without decreasing the sweep time) by performing video averaging. For further details, see SECTION 5.

## Input Attenuator (Atten)

To set the input attenuator, perform the following key operations.

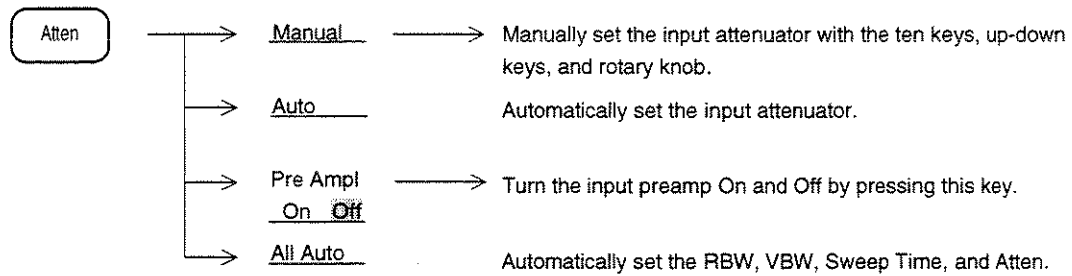

### (1) Auto mode

When the reference level is set while Auto is selected, the input attenuator is automatically set to the optimum value according to the reference level.

## (2) Manual setting

When a signal with the same level as the reference level is input, the input attenuator value in the Auto mode is controlled so that high accuracy measurements can be made without being influenced by gain compression and the noise level can be reduced. However, when you want to measure a low level signal by raising the sensitivity when measuring nonharmonic spurious response and the spurious response of adjacent signals, measurement may be impossible because the Atten values in the Auto mode are too large. In this case, set the input attenuator manually according to the table above.

Reference Level and Input Attenuator (Manual)

Reference Level effective range (dBm)	Atten Manual (dB)
+30 ~ -30	70
+30 ~ -40	60
+30 ~ -50	50
+30 ~ -60	40
+20 ~ -70	30
+10 ~ -80	20
0 ~ -90	10
-10 ~ -100	0

A small input attenuator value can be set within the range at which internal mixer level = {(same input level as reference level) - (input attenuator set value)} is -10 dbm or less.

For second and third harmonic measurements, the influence of internal distortion must be eliminated by decreasing the mixer input level. Because the internal distortion is -80 dB when the mixer input level is -30 dBm, when wanting to measure spurious harmonics up to -80 dB, the mixer input level must be made -30 dBm or less. In this case, set the input attenuator manually because the Atten value in the Auto mode is too small.

## SECTION 8

# AUTOMATIC CALIBRATION AND LEVEL CORRECTION FUNCTION

This section describes the internal calibration function and measuring system level correction function which minimize the spectrum analyzer measurement error.

## TABLE OF CONTENTS

Automatic Calibration Function CAL .....	8-3
Automatic Calibration .....	8-4
Details of Each Calibration Item .....	8-5
Preselector tuning .....	8-6
Measurement System Level Correction .....	8-7

# SECTION 8 AUTOMATIC CALIBRATION AND LEVEL CORRECTION FUNCTIONS

## Automatic Calibration Function ..... CAL

The spectrum analyzer incorporates a 625 kHz calibration oscillator and a calibration attenuator, which perform automatic calibration so that the spectrum analyzer can minimize measurement errors and make high accuracy measurements.

### WARNING

If calibration is executed with an external signal applied to the RF input, the correct calibration value cannot be obtained. Perform calibration without applying a signal to the RF input connector.

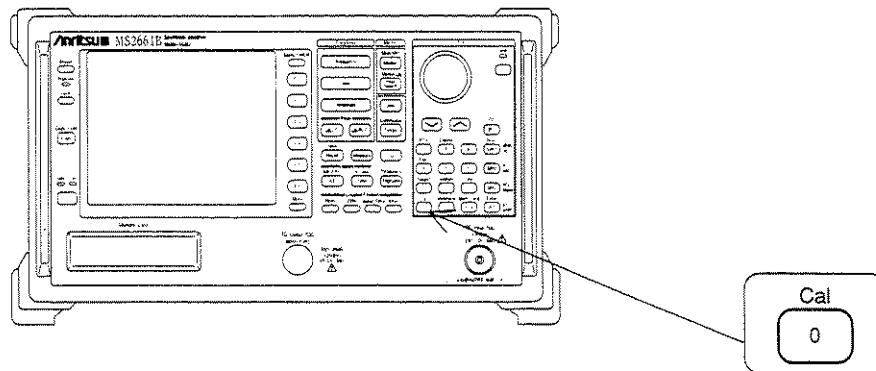

# Automatic Calibration

Execute spectrum analyzer automatic calibration by performing the following key operations.

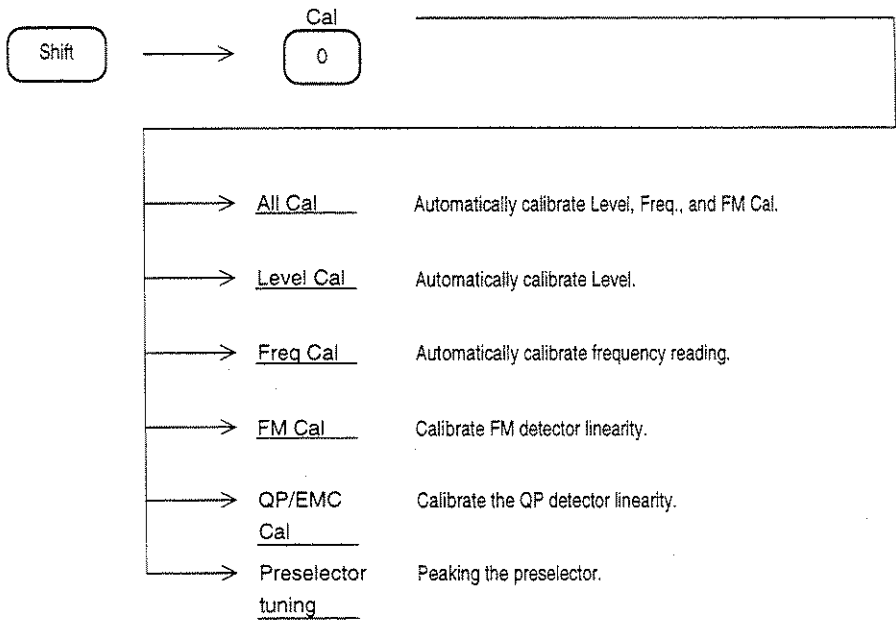

## Details of Each Calibration Item

The following describes the items that are calibrated by the automatic calibration function and the items that are calibrated at the factory.

ALL CAL	LEVEL CAL	Reference level error calibration	Calibrates the absolute-value levels on the LOG/LIN scale.
		LOG-scale linearity calibration	Calibrates the LOG-scale linearity.
		IF Gain switching error correction	Calibrates the error caused by the IF gain from among the level errors when the reference level is switched.
		RBW switching error calibration	Calibrates the error when the resolution bandwidth (RBW) is switched.
		Detection-mode switching error calibration	Calibrates the level error when the detection mode (Pos Peak, Sample, Neg Peak) is switched.
		Input-attenuator/pre-amplifier switching error calibration	Calibrates the level error when the input-attenuator/pre-amplifier is switched.
	FREQ CAL	RBW center frequency calibration	Calibrates the center frequency error when the resolution bandwidth (RBW) is switched.
		RBW bandwidth measurement	Measures the RBW bandwidth used for noise measurement bandwidth conversion.
	FM CAL	FM detector linearity calibration	Calibrates the linearity of the FM detector for monitoring FM demodulated waveforms.
Factory Calibration		Frequency response calibration	Calibrates the amplitude frequency response over the entire band.

When ALL CAL is executed, the calibration data is retained by the built-in battery back-up even when the spectrum analyzer power is turned off. Therefore, it is not always necessary to execute automatic calibration each time the power is turned on. However, when a particularly high accuracy measurement is required, when the specifications are not met, or when the set-up circumstances have changed greatly (such as ambient temperature), execute automatic calibration again.

- Notes:
- Since the built-in calibration oscillator is automatically connected internally when automatic calibration is executed, external connection is unnecessary.
  - Unless the frequency span is taken into account, the measurement frequency error depends on the local oscillator frequency error and the IF center frequency error. The local oscillator is a synthesizer system and its frequency error depends on the frequency accuracy of the reference crystal oscillator or external reference signal input. Frequency-related automatic calibration calibrates the IF center frequency error.

## Preselector tuning

This function is an MS2653B/2663B/2663C dedicated function. It cannot be used in the MS2651B/2661B/2661C. Since this equipment is a superheterodyne type spectrum analyzer, it generates unrequired wave responses such as image responses and multiple responses.

This equipment uses a preselector to remove these unrequired wave responses and to display only true signals on the screen. The preselector is a variable synchronous type bandpass filter that follows the receiving frequency of an analyzer. Since the MS2653B/2663B/2663C uses the preselector in the band 1- (2.92 to 6.5 GHz) and band 1+ (6.4 to 8.1 GHz), the peaking is described below:

In normal use, since the initial value of the peaking bias is set for each frequency, peaking is required only when the bias value is shifted purposely.

If it is shifted, the receiving level is decreased as shown in the diagram at the bottom left. Accordingly, perform peaking so that the maximum response can be obtained as shown in that figure.

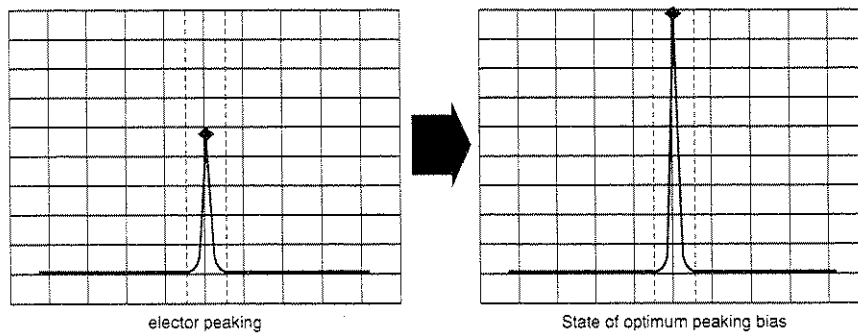

Perform peaking using the following method.

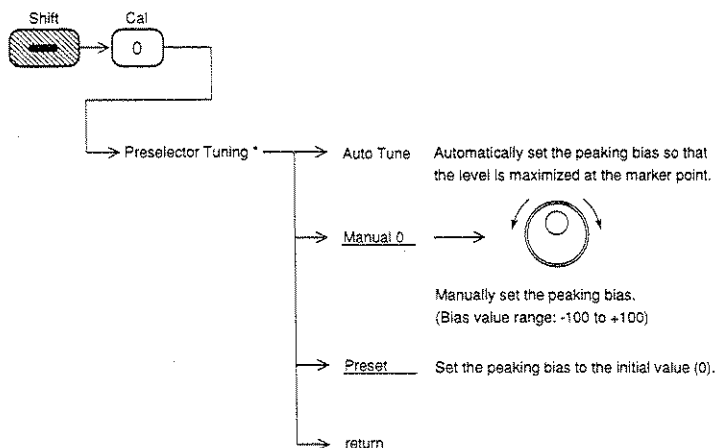

Note: Preselector Auto Tuning cannot be done when:

- The frequency span exceeds 500 MHz.
- The marker is OFF.
- Trace BG is the main trace in the trace A/trace BG indication.
- The FM/TRIG monitor mode is active in the Time Trace.



## Measurement System Level Correction

When making measurements with a spectrum analyzer, it may be necessary to correct the error and gain of the measurement system. The following are examples of this.

- ① Frequency characteristics and loss of measurement cables
- ② Frequency characteristics and loss of pre-amplifier, etc. connected to RF input connector
- ③ When wanting to measure the field strength with an antenna or near-field probe connected (antenna factor correction)

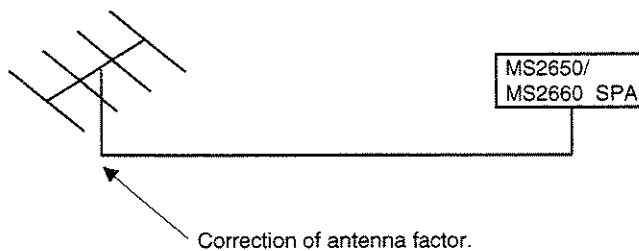
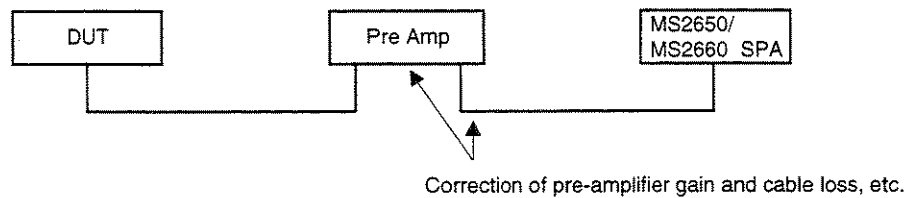
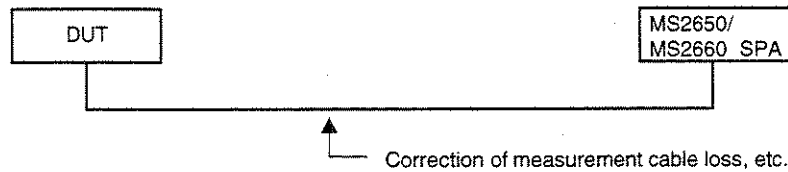

The correction factors for these measurement systems can be stored in the internal memory to add the factor to the measured value and display the spectrum.

Up to five correction factors (maximum 150 points each) can be stored in the internal memory by storage from an external computer via an external interface or by using the internal PTA. For a more detailed explanation of these methods, refer to the Remote Control part of the separate operation manual.

SECTION 8 AUTOMATIC CALIBRATION AND LEVEL CORRECTION FUNCTIONS

The following shows the procedure for adding the correction factor to the measured value by using the correction data saved in advance.

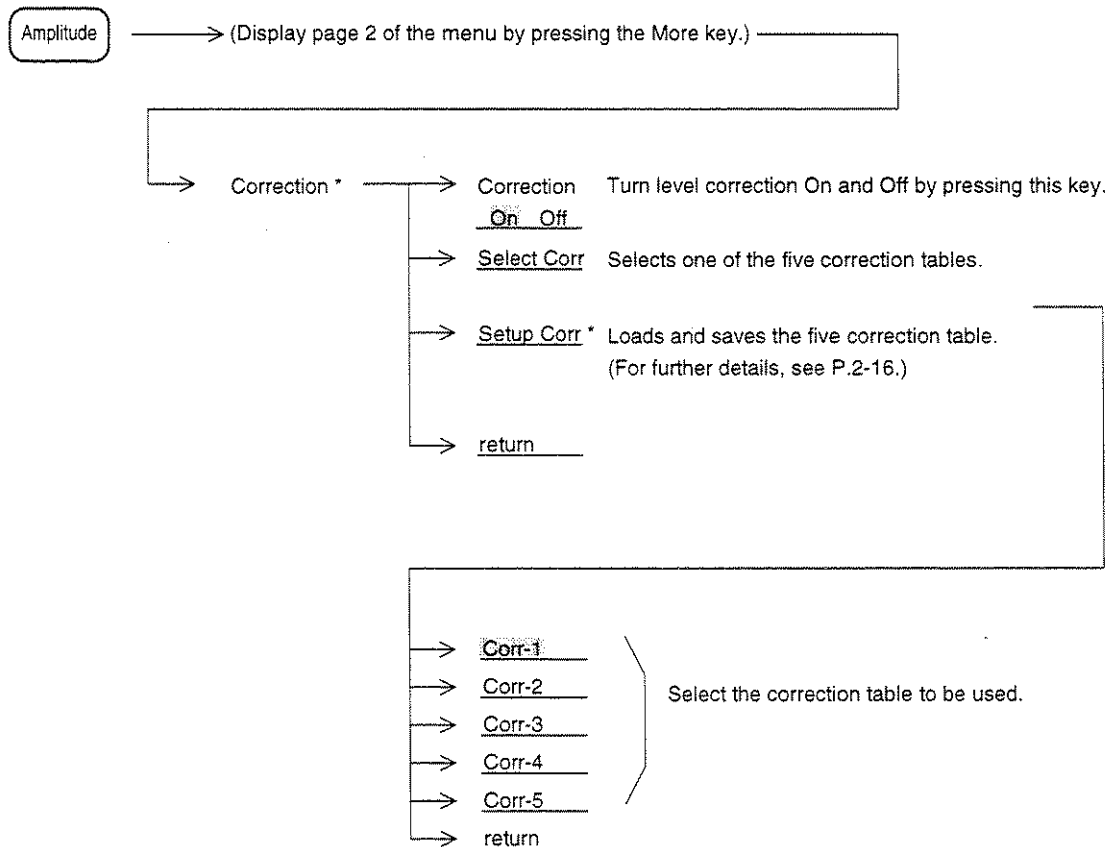

Press one of the Corr-1 to Corr-5 keys. The spectrum data is corrected and displayed by the corresponding correction value.

If the frequency range over which the correction values are entered is from  $F_a$  to  $F_b$ , displayed frequency ranges lower than  $F_a$  or higher than  $F_b$  have correction values applied as shown in the figure below. The correction value for frequencies lower than  $F_a$  is the same as that ( $L_a$ ) for  $F_a$  and the correction value for frequencies higher than  $F_b$  is the same as that ( $L_b$ ) for  $F_b$ .

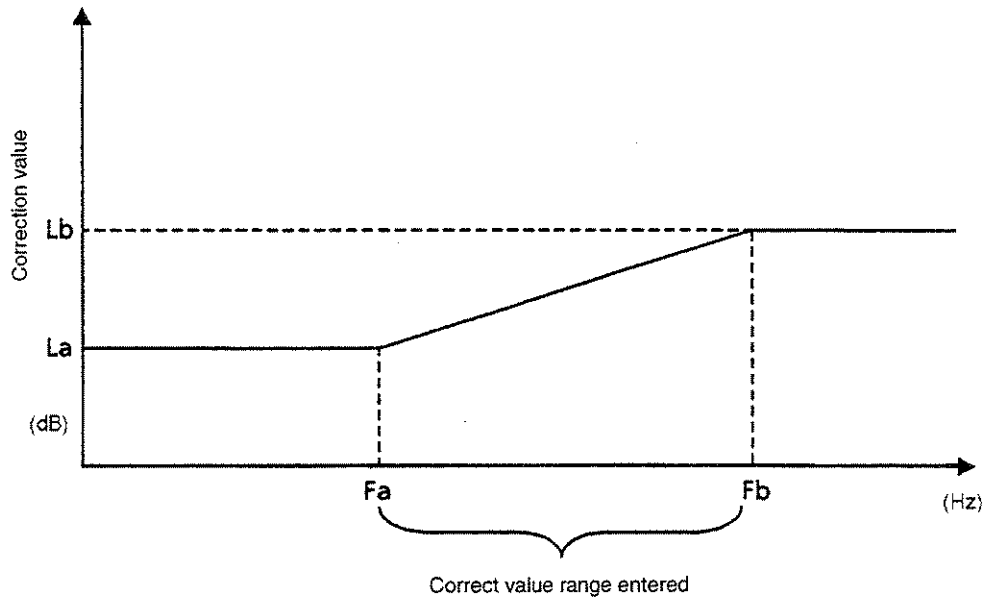

- Notes:
- ① No correction factor is entered at the factory. The correction values are all 0 dB.
  - ② The correction value is backed-up by a battery. Therefore, once the value has been entered, it is not lost even after the power is turned off.
  - ③ The Corr-1 to Corr-5 soft keys allow each menu label to have up to 20 characters. The labels can be entered from the remote control command only. For further details, refer to the Remote Control part of the separate Vol.3 operation manual.

# SECTION 9

## SYSTEM SETTING AND PRESET FUNCTION

This section describes the spectrum analyzer system setting method and the measurement parameters preset function.

### TABLE OF CONTENTS

Coupled Function Common/Independent Setting Mode .....	9-4
Screen Display Type System Setting .....	9-6
Modifying Display Color (Change Color) .....	9-7
User Definition of Display Color .....	9-8
Adjusting LCD Brightness .....	9-9
Setting Composite Out .....	9-10
Conditions Setting at Power-on .....	9-10
Setting Mode at Auto Sweep Time .....	9-11
Setting Date/Time .....	9-11
Erasing Warm up Message .....	9-12
Switching "X-out, Z-out" output specification in a zero span sweep .....	9-12
Setting Domain Sweep .....	9-13

# SECTION 9 SYSTEM SETTING AND PRESET FUNCTION

The following system parameters of the spectrum analyzer can be set depending on the usage objective.

- Frequency domain and time domain coupled function  
value common/independent setting ..... Coupled Common Independent
- Measurement parameters and date display type setting ..... Display
- Screen display color (color pattern) setting ..... Change Color
- Adjusting LCD brightness for comfortable viewing depending on  
vertical angle of observation ..... LCD Brightness
- Setting Composite Out ..... Composite Mode
- Setting Mode at Auto Sweep Time ..... Auto SWT
- Setting Date/Time ..... Set Date/Set Time
- Erasing warm up message ..... Erase Warm up Message
- Power on state setting ..... Power On State
- Switching X-out, Z-out output specification in a zero span sweep ..... Zero Span
- Setting skipping sweep ..... Freq Domain, Unlock count

These system settings are independent from, and are not affected by, the preset function.

However, they are included in the Save parameters described in SECTION 10, so the system settings may have changed when recalled.

## Coupled Function Common/Independent Setting Mode

At factory shipment, the four coupled functions RBW, VBW, Sweep time (Time Span), and Atten are set to have the independent value for frequency domain and time domain.

When these coupling functions are desired to be used with the same sense of operation as zero span of a traditional spectrum analyzer, they can be set commonly by making the following system settings.

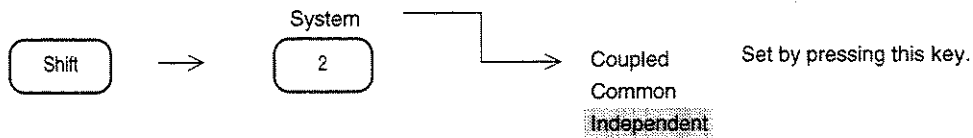

Common	.....	The same values are set for both frequency domain and time domain.
Independent	...	Different values are set for frequency domain and time domain.

The Atten value cannot be set independently. When the coupled mode is set to Independent, "RB" and "VB" displayed at the top of the screen change to "RBt" and "VBt", respectively.

**Note:** The sweep time (time span) setting range and resolution in the frequency domain and the time domain differ as shown below. In some cases, the same values cannot be obtained even if the coupled mode is sent to Common.

#### Frequency domain

20 msec to 1000 sec

Resolution: High-order 2 digits

#### Time domain

12.5  $\mu$  s, 25  $\mu$  s, 50  $\mu$  s, 100  $\mu$  s to 1000 sec (with option 04)

Resolution: High-order 1 digit (100  $\mu$  sec to 900  $\mu$  sec)

High-order 2 digits (1 msec to 1000 sec)

**Example:** After switching to the time domain mode to set the time span to 100  $\mu$  sec when the sweep time is 300 msec in the frequency domain mode, the display mode returns to the frequency domain mode.



Since the lower limit value of the sweep time that can be set in the frequency domain mode is 20 msec, the sweep time is set to the 20 msec nearest to 100  $\mu$  sec. Then, when the display mode switches to the time domain mode, the time span is renewed to 20 msec.

## Screen Display Type System Setting

This function selects the measurement parameters display type and date display type that are displayed on the screen.

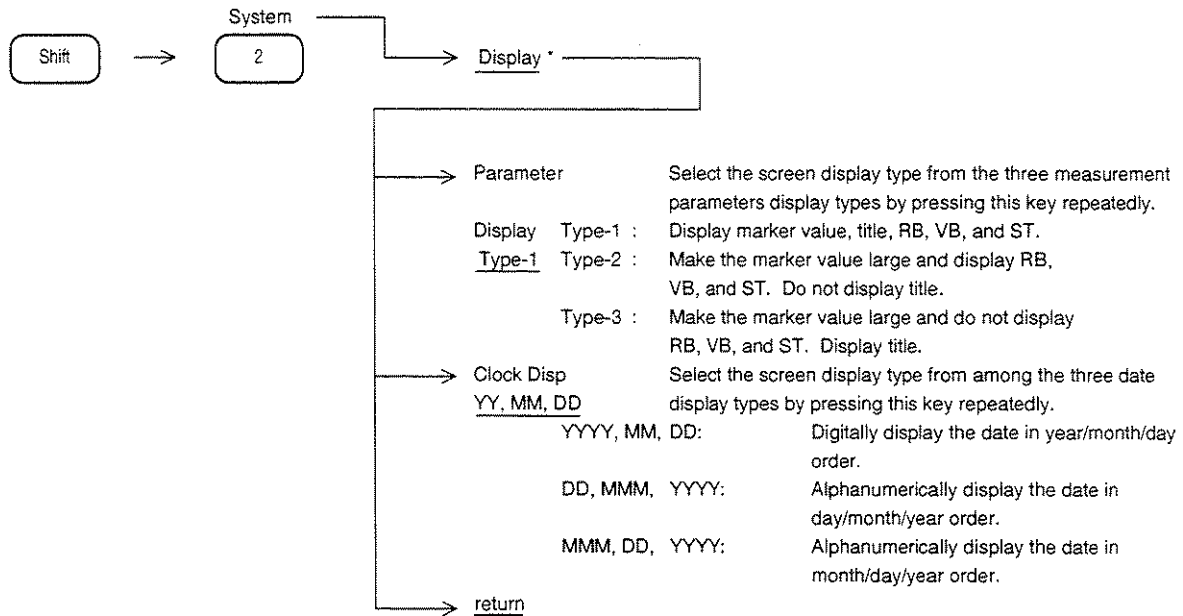



## Modifying Display Color (Change Color)

This function changes the color of the trace waveform, scale, measurement parameters, menu, and other items displayed on the screen. The color pattern can be selected from among four color patterns, or defined by the user.

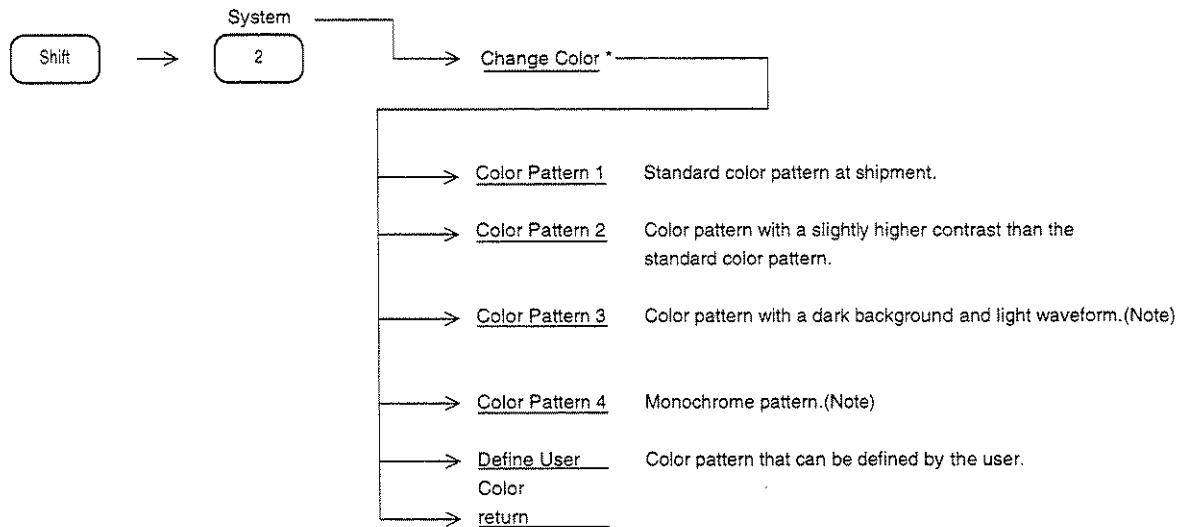

**Note:** Mainly use color pattern 3 when using in the dark place.  
Mainly use color pattern 4 when photographing the display screen.

## User Definition of Display Color

The MS2650/MS2660B/C series spectrum analyzer has a color pattern function that allows the user to define the color of the trace waveform, scale, measurement parameters, menu, and other items displayed on the screen.

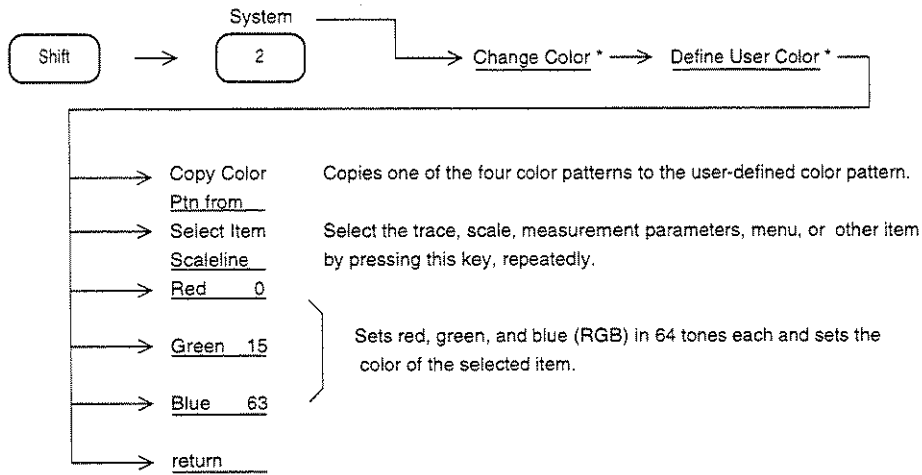

*Note:* *Marker, PTAScreen, Menufield, Menutext, EntryArea, Background, Scalefield, Scaleline, 2ndTrace, 1stTrace, Parameter, Displayline, Trigger, Zone, Temp/Mask, and MultiMarker can be selected.*

## Adjusting LCD Brightness

LCD Brightness can be adjusted by the following key operations.

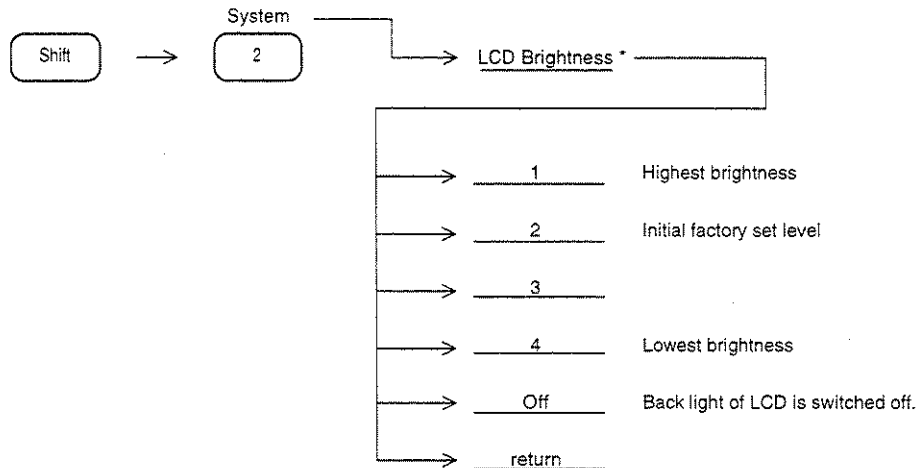

*Note:* LCD type display have a particular range of angle for comfortable viewing depending on the level of brightness of the display.

*In this instrument level of brightness (see figure below) varies from 1 to 4 as the point of observation goes from above to below.*

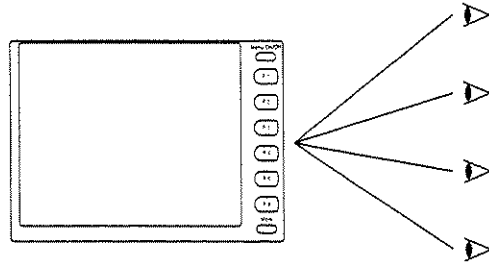

- When the display is in backlight off mode, the brightness can be brought back by either setting a display level 1 to 4 or by the **PRESET** key.
- LCD backlight off mode is useful when there is no need for human observation of the display. Also the speed of processing increased, if the backlight is switched off in remote controlled mode of operation.

## Setting Composite Out

Switching of the Video signal from the Composite Out terminal at the rear panel is carried out by the following key operations.

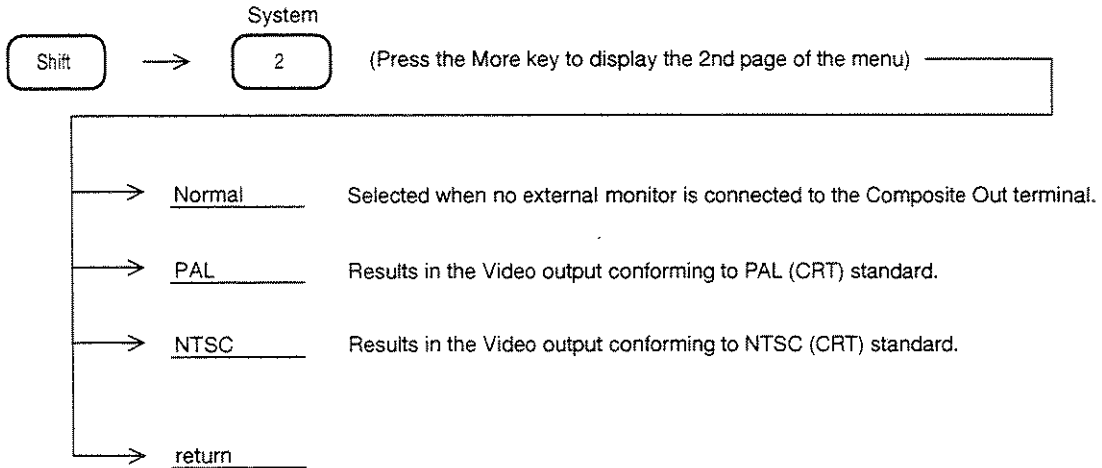

## Conditions Setting at Power-on

Set the state of the screen display when the power is turned on by performing the following key operations.

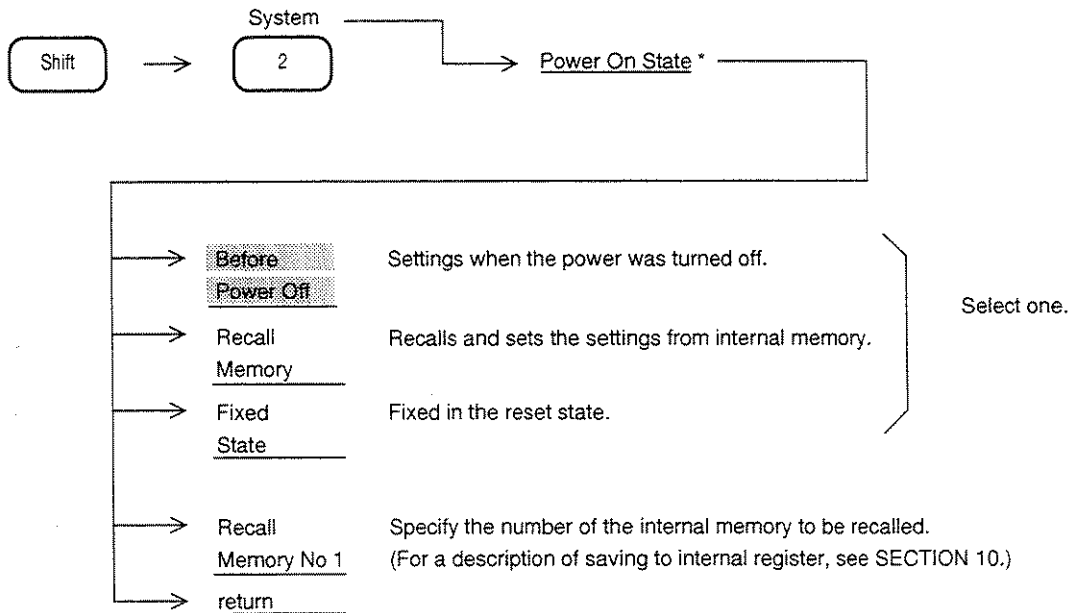

## Setting Mode at Auto Sweep Time

Set the sweep time mode when sweep time is Auto.

Normally, select the Hi-Lvl-Acc mode.

In Fast mode, the sweep time becomes fast, but level-measurement error may increase by approx. 1 dB.

Use this Fast mode in the relative-level measurement such as the adjacent channel leakage power.

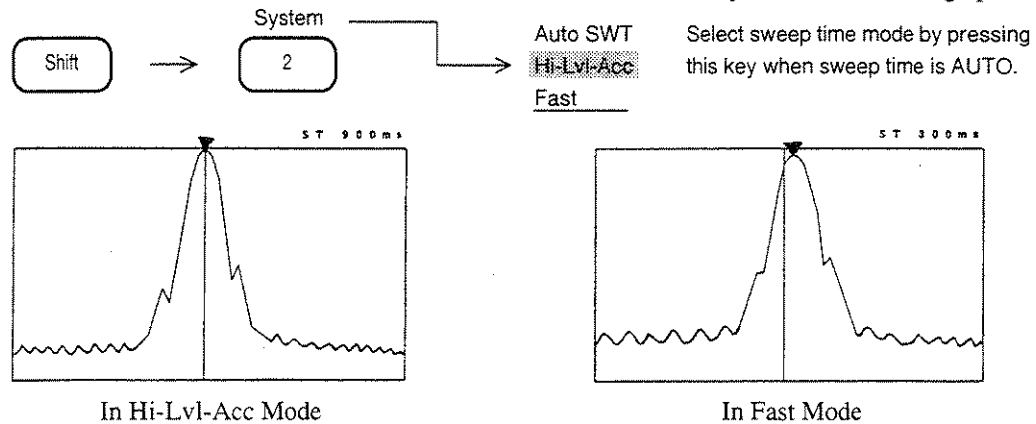

## Setting Date/Time

Set the date and time by performing the following key operations.

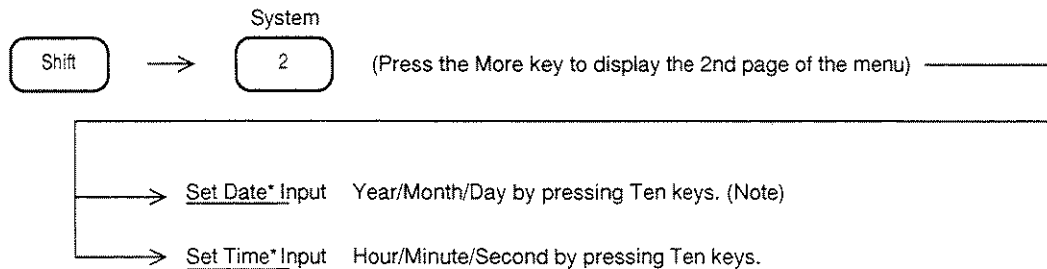

Note: For an example, when inputting 1st January 1996,

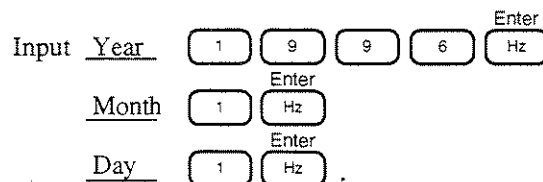

## Erasing Warm up Message

"Warm up" message is indicated on the top right of the display for about 3 minutes after turning on the power. This message is indicated because it is necessary to wait for frequency to stabilize when a frequency span is 200kHz or less. This message can be erased.

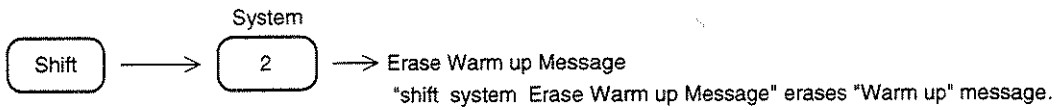

## Switching "X-out, Z-out" output specification in a zero span sweep

Using Option 15, sweep signal output, image signals of spectrum analyzer (X, Y, Z:Y-out is the standard, and X-out/Z-out is an option) can be output and observed by an oscilloscope or the like.

When indicated waveforms are the traces A and B (frequency axes), each signal is output by the following timing.

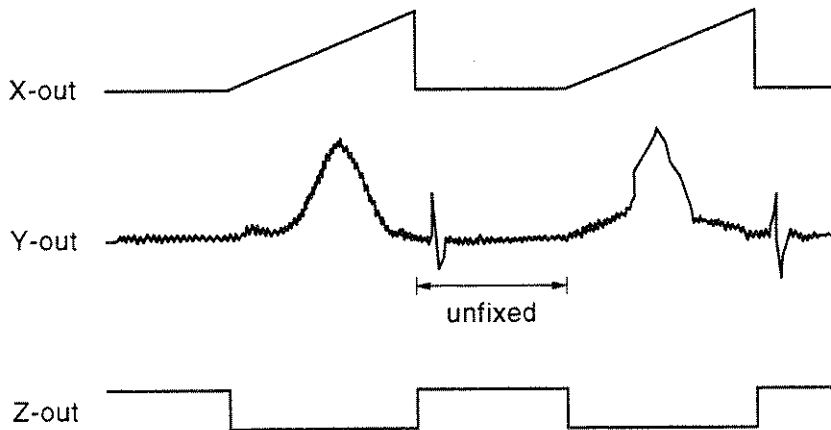

Zero Span Sweep: When trace "Time" (time axis), normally Y-out only is output, and X-out and Z-out are not output. The mode in a zero span sweep is usually set at "Digital". When X-out and Z-out signals are necessary in a zero span sweep, set the zero-span mode at "Analog".

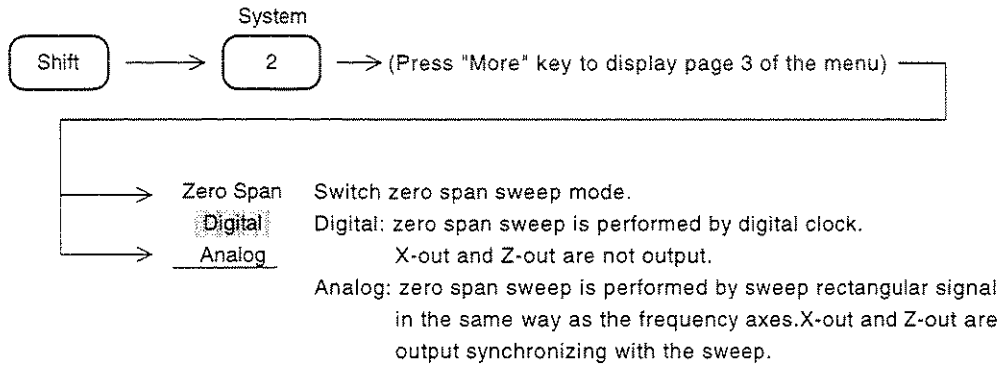

*Note:* When switching the zero span sweep mode to "Analog", a sweep duration is limited to 20ms or more. Even if Option 04 high speed time domain sweep, is mounted, the duration cannot be set at less than 20ms.

## Setting Domein Sweep

Refer the section 6 "Selecting Sweep Method" "Skipping Sweep".

# SECTION 10

## SAVE/RECALL FUNCTION

This section describes saving and recalling of the waveform and parameter data to and from internal register and memory card, respectively.

It also describes memory card file management.

### TABLE OF CONTENTS

Internal Register .....	10-4
Memory Card .....	10-4
Saving Register .....	10-5
Recalling Register .....	10-7
Selecting Recall Item .....	10-10
Memory Card File Management .....	10-11
File Deletion and Write Protect .....	10-12



# SECTION 10 SAVE/RECALL FUNCTION

The spectrum analyzer can save the setting conditions (Parameter) and waveform data (Trace) to internal register and memory card. These data can be recalled and used later.

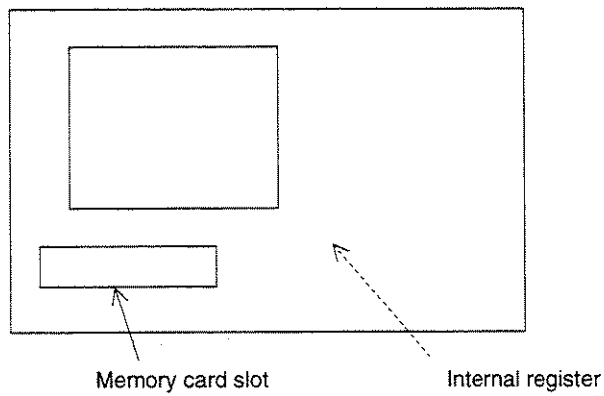

## Internal Register

The internal register uses the RAM backed-up by a battery in the spectrum analyzer.

Up to 12 parameters and waveform data can be saved. Parameters and waveform data, or parameters only, can be recalled.

## Memory Card

The memory card is an interface that corresponds to JEIDA Ver.4/4.1 type 2, and PCMCIA Rel.2.0, 2 slots.

Memory capacity can be selected from among 256kB, 512kB, 1024kB, and 2048kB.

Parameters and waveform data can be saved and parameter and waveform data, or parameters only, can be recalled.

(A 256kB memory can save more than 50 files.)

PTA programs created by external controller, etc. can also be uploaded and downloaded.

## Saving Parameter and Waveform Data

To save the current parameters and waveform data and title to internal register or memory card, perform the following key operations.

When a title is necessary, enter it in advance. (See SECTION 12.)

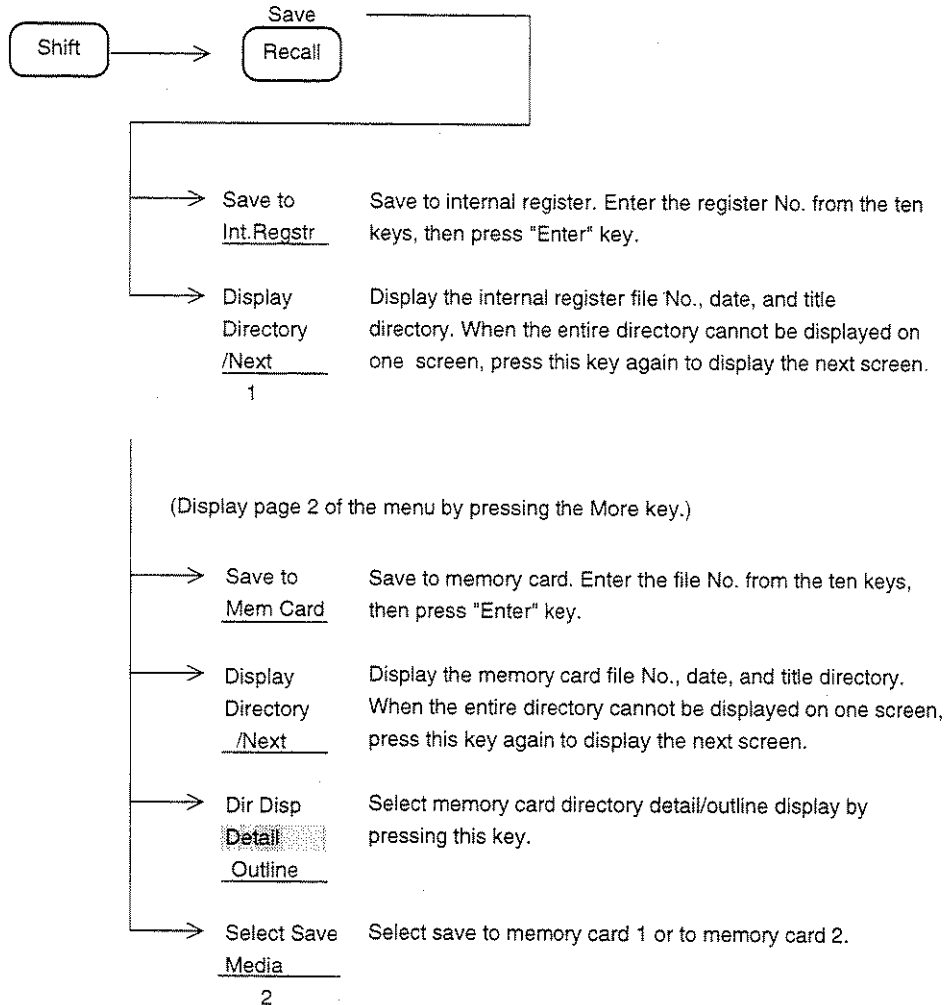

**Note:** Since the Save operation overwrites the data written using the same register/file number, check the directory before doing any saving.

<Memory Directory>			<u>save</u>
No.	Date	Title	
01	95-09-15	Noise Level Measurement	
02	95-09-23	FALL 0923	
10	95-10-10	SPRT 1010	
12	95-11-03	CLTR	

Save Int. Reg. NO=

Internal Register Directory Display Screen

## Recalling Parameter and Waveform Data

To recall the saved parameters and waveform data or parameters only from internal register or memory card, perform the following key operations.

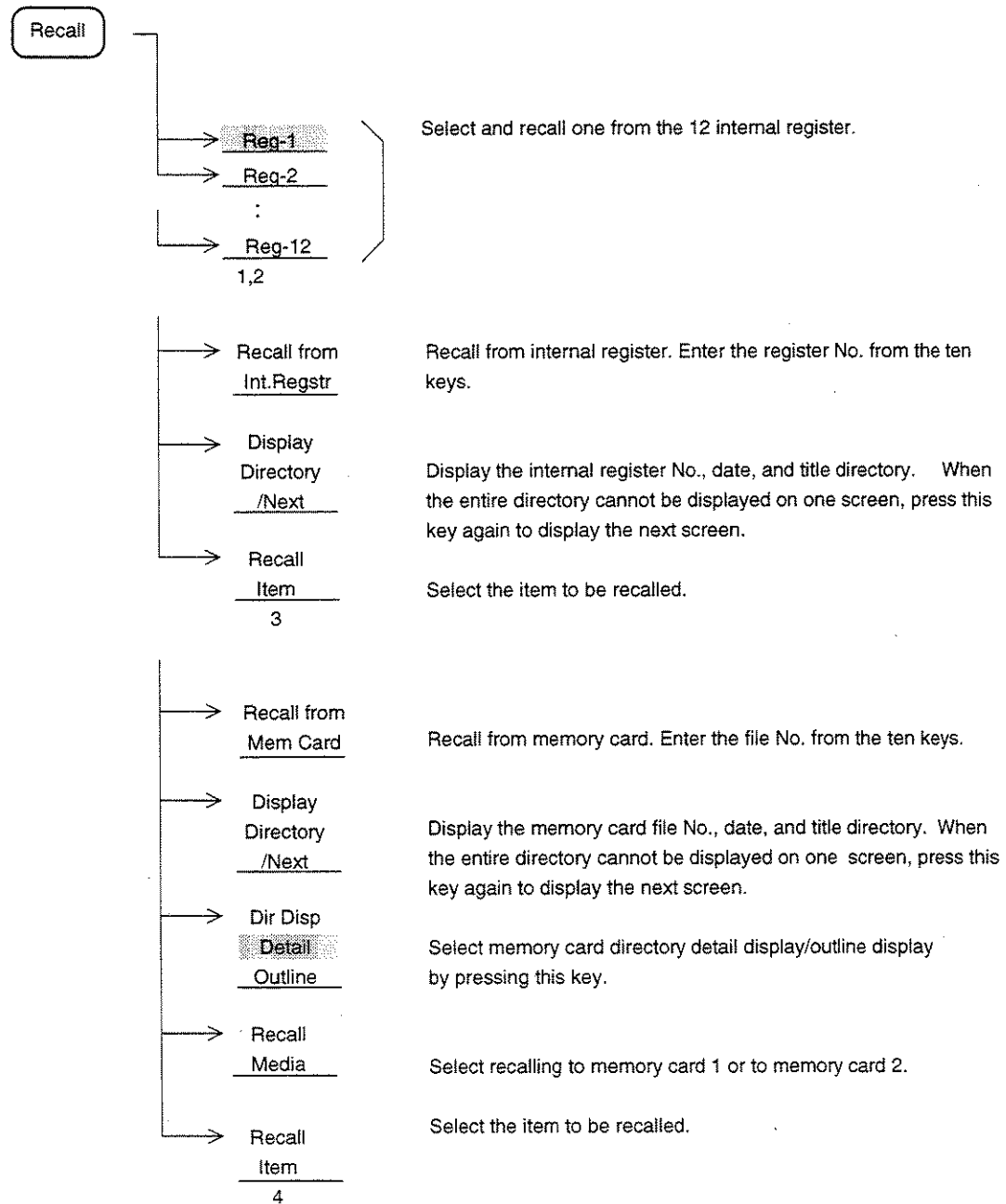

- Notes:
- ① Waveform data should be saved in the View storage mode or in the state while stopped after a single sweep. Resweep immediately after recall clears from the screen display the data saves during continuous sweep.
  - ② The Cumulative and Overwrite storage modes allow the last-swept waveform data to be saved.
  - ③ Since the system settings described in SECTION 9 MEASUREMENT SYSTEM SETTING (Coupled Mode) are included in the parameters to be saved, they may have changed when recalled.

<File Directory>		Recall
Media: Mem Card-1		
Unused Area: 205 824 byte		
31 Files in \P-2110\TRACE		
Name	Title	Bytes Date Protect
TRACE001	DAT Carrier	Power Measure
2608	96-05-16	09:04 Off
TRACE002	DAT Power steps	Measure
2608	96-05-16	09:04 Off
TRACE003	DAT PvsT full frame	Measure
2608	96-05-16	09:04 Off
TRACE004	DAT PvsT full slot	Measure
2608	96-05-16	09:04 Off
TRACE005	DAT PvsT top 10dB	Measure
2608	96-05-16	09:04 Off
Recall File No =		

(Detail)

<File Directory>		Recall
Media: Mem Card-1		
Unused Area: 205 824 byte		
31 Files in \P-2110\TRACE		
No.	Date	Title
001	96-05-16	Carrier Power Measure
002	96-05-16	Power steps Measure
003	96-05-16	PvsT full frame Measure
004	96-05-16	PvsT full slot Measure
005	96-05-16	PvsT top 10dB Measure
006	96-05-16	PvsT Rising edge Measure
007	96-05-16	PvsT Falling edge Measur
008	96-05-16	Intermod measure (carr
009	96-05-16	BS Tx band(800kHz abov
010	96-05-16	BS Tx band(800kHz belo
011	96-05-16	BS Rx band(3rd) measure
Recall File No =		

(Outline)

Memory Card Directory Display Screen

**CAUTION** 

---

This notice relates to revision of software of ROM (0 to 3) from version (1.0 to 1.49) to version (1.50 & above).

The data saved on a spectrum analyzer with a newer version can not be recalled on an analyzer with an older version.

However the data saved on an older version analyzer can be recalled on an analyzer with a newer version.

The version of the analyzer's ROM is displayed on the screen when the instrument is turned on.

---

## Selecting Recall Item

Select the item to be recalled by performing the following key operations.

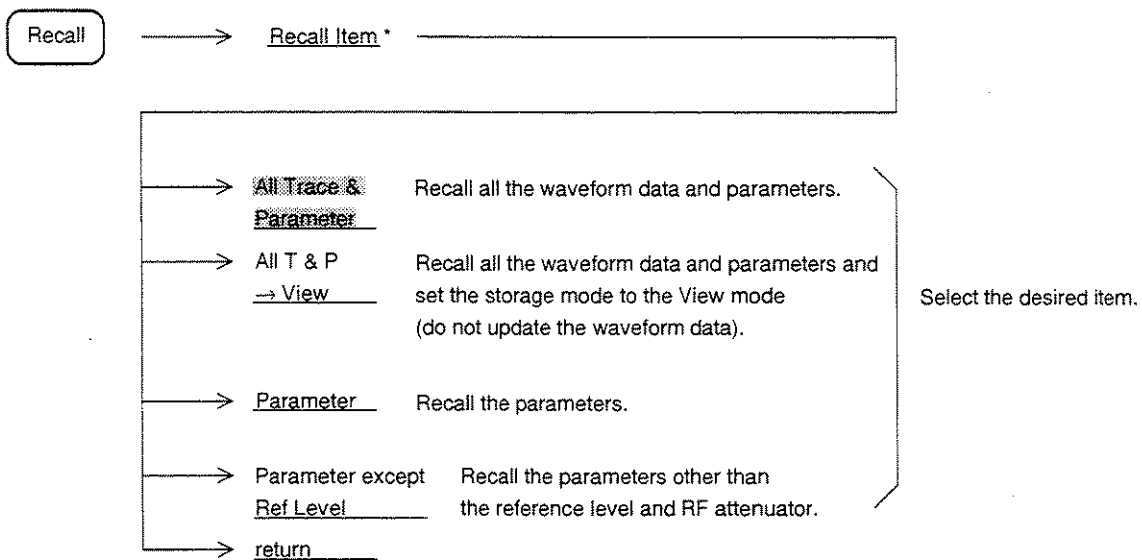



## Memory Card File Management

This parameter describes the memory card format, file deletion, and write protect key operation.

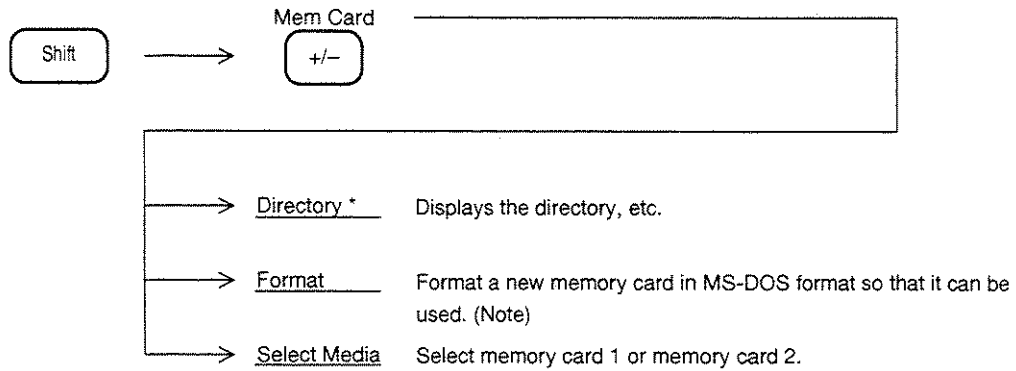

**Note:** When a memory card is formatted, all the file contents are deleted even if they are write-protected as described below.

MS-DOS is a registered trade mark of the Microsoft Corporation.

## File Deletion and Write Protect

To delete a file and set write protect, perform the following key operations.

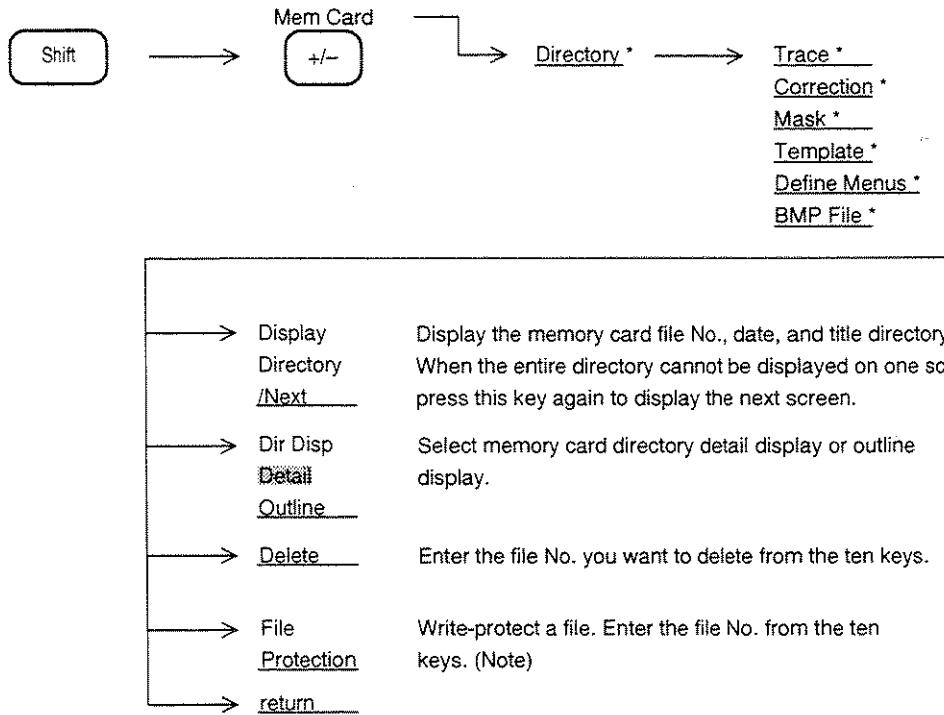

**Note:** The operation above releases write protection of the protected file.  
Write-protected files are displayed with "protect" in the memory card directory displayed set to "on" and cannot be saved or deleted.  
Note that the formatting deletes the protected file.

# SECTION 11

## COPY/SOUND MONITOR/TV IMAGE MONITOR

This section describes the COPY function for hard-copying the contents displayed on the screen, the SOUND function for monitoring an AM or FM modulated sound signal, and the TV-image monitor function for displaying a TV screen.

### TABLE OF CONTENTS

Direct Plotting .....	11-3
Connecting to Printer and Plotter .....	11-3
Selecting a Printer/Plotter .....	11-4
Selecting a Printer .....	11-5
Setting the Plotter .....	11-6
Setting Interface .....	11-7
Executing Hard Copy .....	11-8
Saving Screen Image Data to Memory Card .....	11-9
Selecting Memory Card .....	11-9
Executing Save .....	11-9
Executing Save by Specifying File Number .....	11-10
Displaying the Screen Image Data on PC .....	11-10
Displaying a Title .....	11-11
SOUND Monitor .....	11-12
AM Wave Sound Monitor .....	11-13
FM Wave Sound Monitor .....	11-13
TV Image Monitor .....	11-14

# SECTION 11 COPY/SOUND MONITOR/TV IMAGE MONITOR

## Direct Plotting

The spectrum analyzer can output a hard copy of the screen as follows:

- ① Using a printer via RS-232C interface.
- ② Using a printer via GPIB interface.
- ③ Using a printer via Centronics (Option) interface.
- ④ Output to a plotter in the specified format via RS-232C interface.
- ⑤ Output to a plotter in the specified format via GPIB interface.

However, the printer is limited to HP dot image and EPSON dot image types.

The plotter is limited to HPGL and GPKL types.

## Connecting to Printer and Plotter

Connect the spectrum analyzer and printer/plotter as shown below.

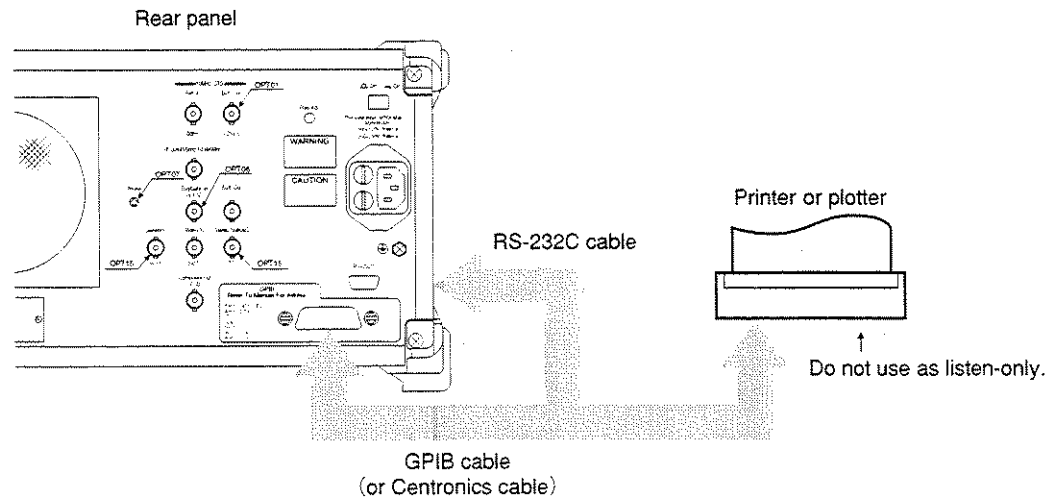

## Selecting a Printer/Plotter

To select printer/plotter, set-up the printer/plotter, feed the paper, stop printing, etc., perform the following key operations.

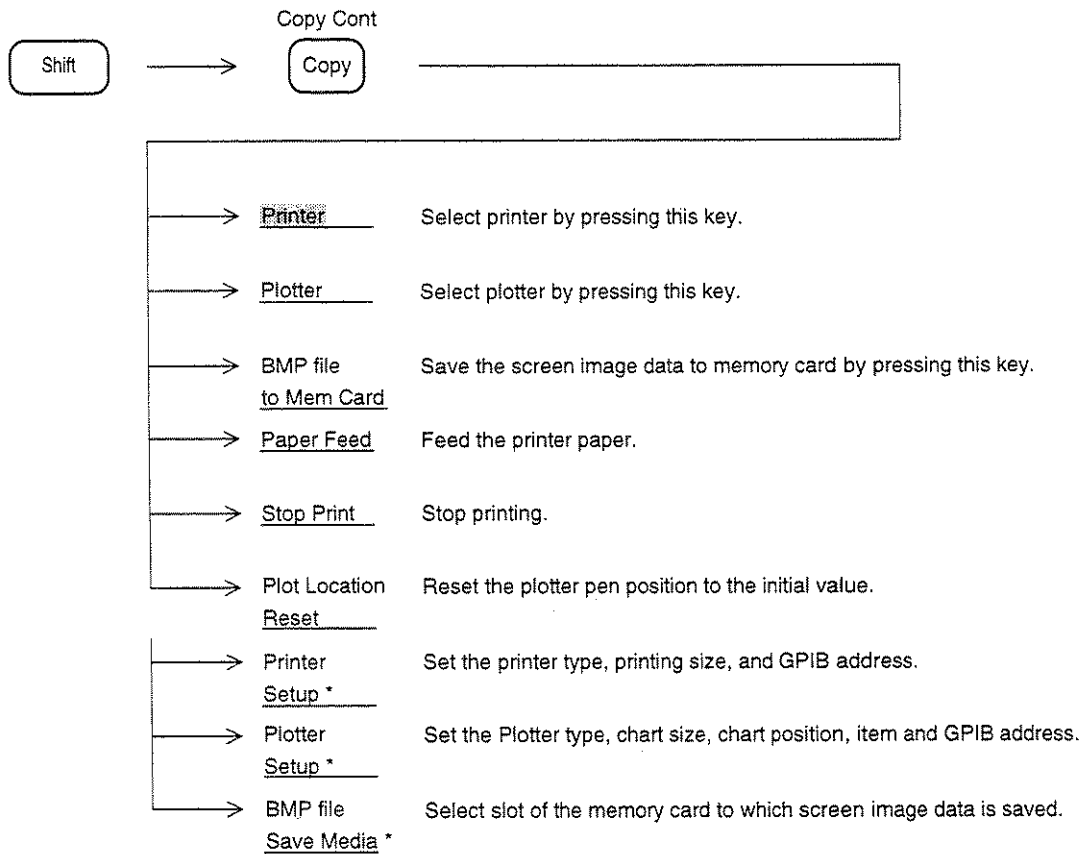

## Selecting a Printer

To select the printer to use and to set its GPIB address, perform the following key operations.

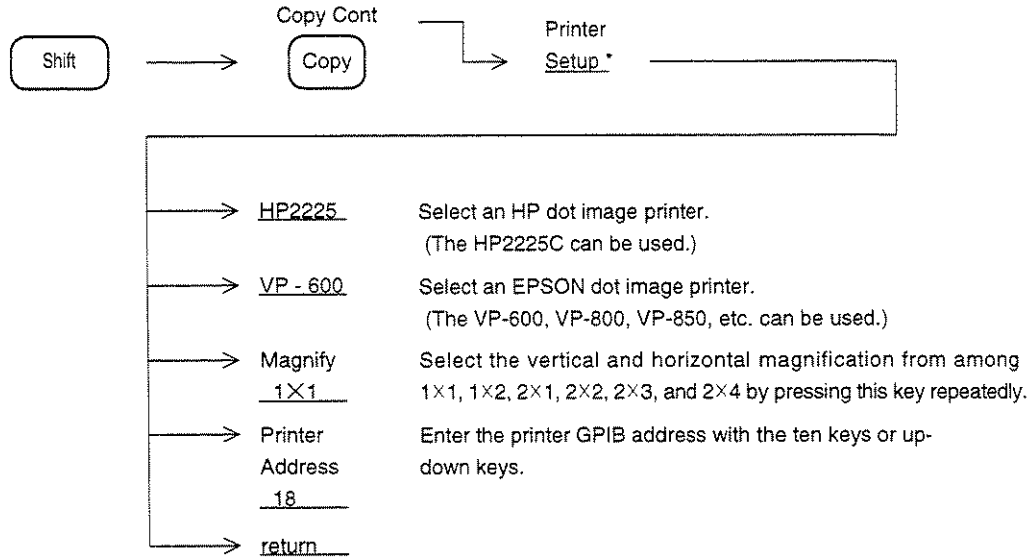

1×1      1×2

2×1      2×2

2×3

2×4

Print Magnification Selection

## Setting the Plotter

To select the plotter to use and to set its GPIB address, perform the following key operations.

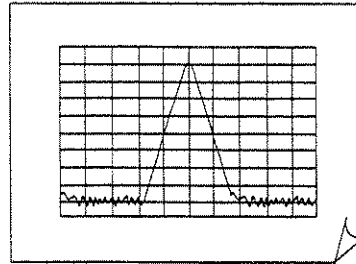
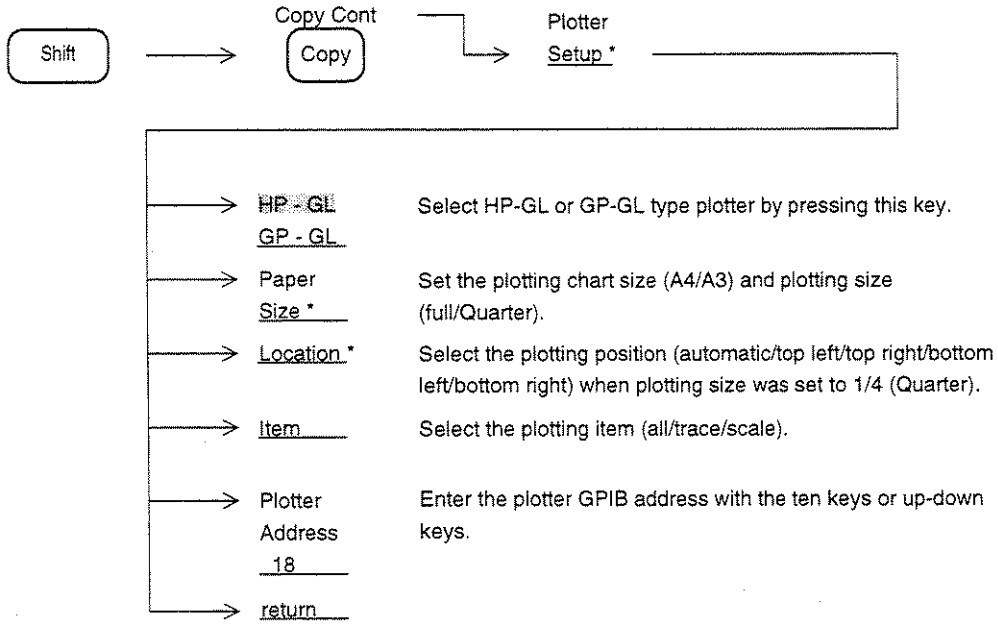

When Full Size is Specified for Plotting

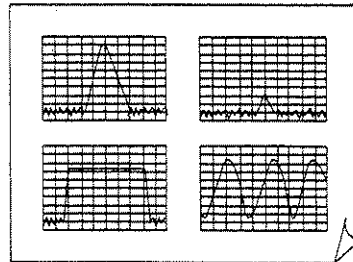

When Quarter Size is Specified for Plotting

## Setting Interface

To set the RS-232C baud rate and interface with external devices, perform the following key operations.

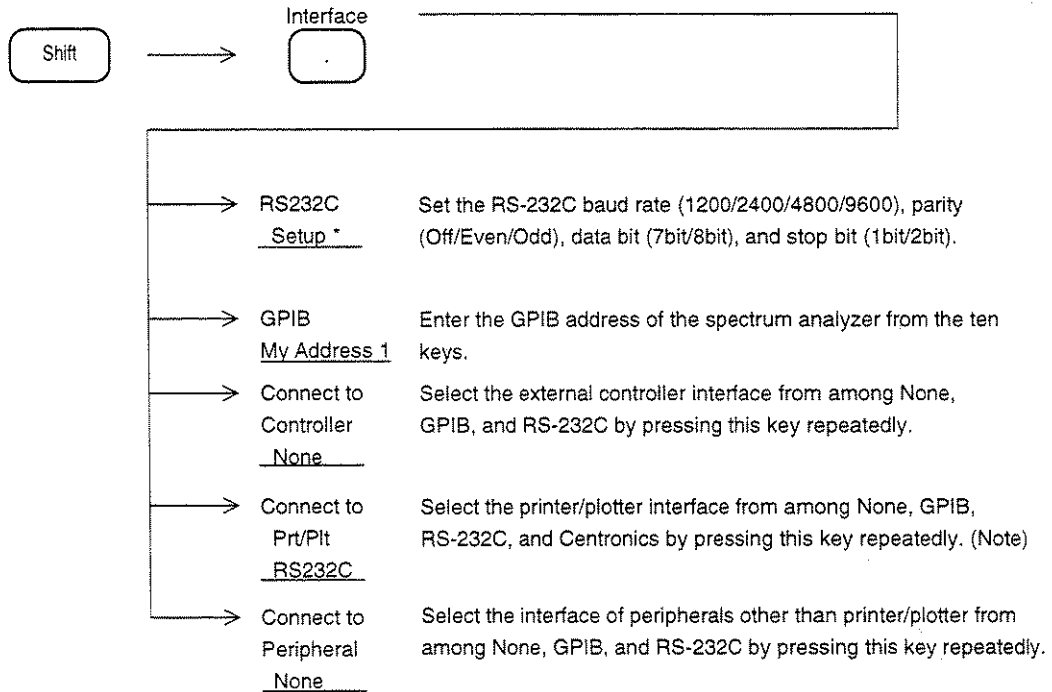

Note: When GPIB is selected as the external controller, for Prt/Plt, select from None and RS-232C.



## Executing Hard Copy

Start hard copy by pressing the  key. When the screen-image data saving is selected, saves the data to the memory card.

Note: Set the printer or plotter to the ON LINE mode.

Notes: • Some printer and plotter models take a considerable time to output a hard copy. This may cause a time-out error in the spectrum analyzer and the hard copy operation may be interrupted. In this case, modify the time-out setting value via GPIB using an external controller.

```
N88-BASIC ..... PRINT Δ@ 1; "GTOUT Δ 60"
```

```
PTL ..... PUT Δ "GTOUT Δ 60"
```

Integer represented in units of second(s)

- Immediately after setting the copy execution, the sweep stops for a few seconds because of editing process of the data. After restarting the sweep, and beginning the printing at printer/plotter; the parameters etc. can be set. After completion of the current copying, perform the next copying.

## Saving Screen Image Data to Memory Card

The screen display contents can be saved to a memory card as a BMP-format(standard image data format of the Windows) file. After saving, the file in the memory card can be opened on the Windows of PC.

### Selecting Memory Card

To select the screen-image-data saving function and the memory-card slot at the front panel, perform the following key operations.

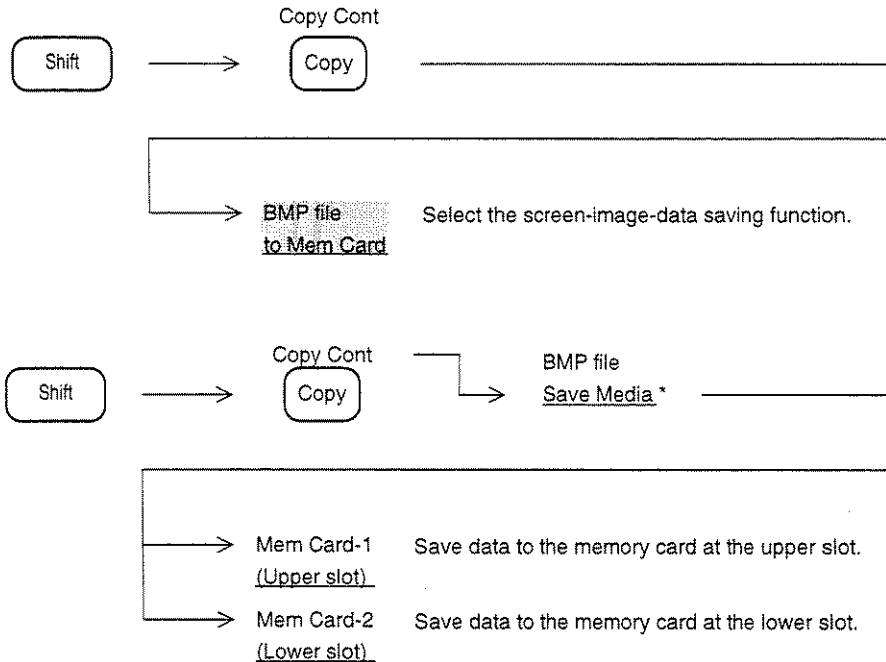

### Executing Save

Saves the screen-image data to a memory card by pressing the **Copy Cont** **Copy** key.

File name to be saved is automatically numbered.

When the menu is displayed in this saving mode, it is also saved as it is.

Use the memory card which is formatted by the spectrum analyzer.

## Executing Save by Specifying File Number

To save the screen-image data to a memory card by specifying a file number to be saved, perform the following key operations..

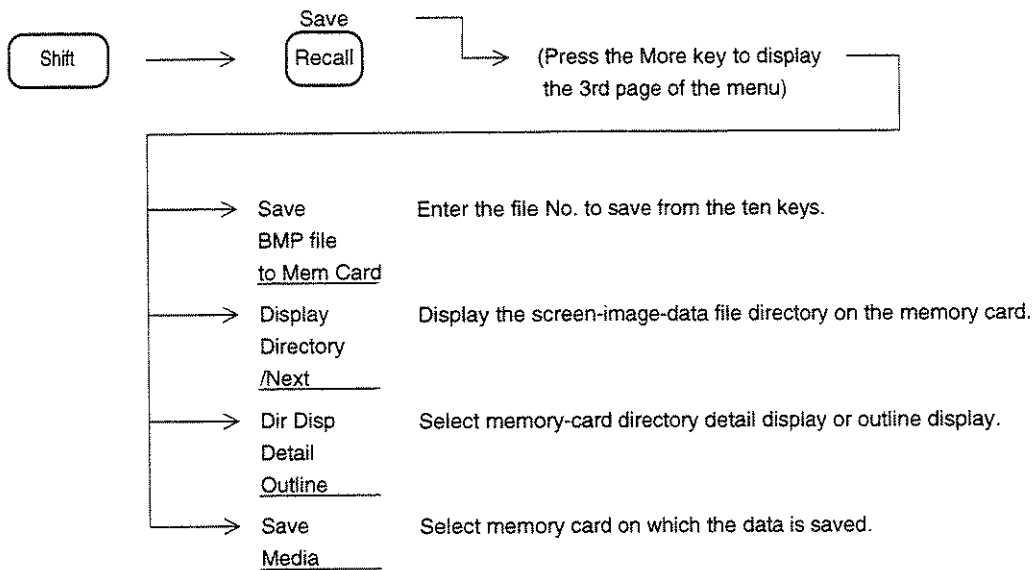

After deleting the menu and data input in this saving mode, only the screen-image-data is saved. Use the memory card which is formatted by the spectrum analyzer.

## Displaying the Screen Image Data on PC

The saved screen image data can be displayed on a personal computer(PC) with a tool on PC (ex. the paint brush of Windows).

The saved files on a memory card are in the directory as shown below.

¥P-2110¥COPY¥COPY001.BMP

↑  
File No.

## Displaying a Title

A character string of up to 19 letters can be displayed in the title display field at the top of the screen. To display a title character string, perform the following key operations.

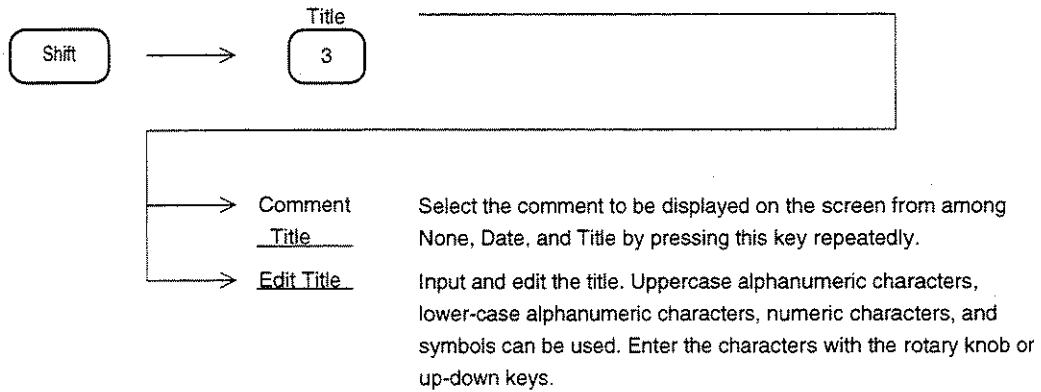

Title: Meas Fre <u>q</u>	Count On	Edit	
<div style="border: 1px solid black; padding: 5px; margin-bottom: 5px;">           ABCDEFGHIJKLMNOPQRSTUVWXYZ            abcdefghijklmnopqrstuvwxyz            0123456789-+*/=!"#%&amp;'()_.            /!@[ ]{}:;.,&lt;&gt;?_         </div> <p>Select the characters by turning the rotary knob. After setting the title, press the [Return] key.</p>		←	Move Title cursor to the left.
		→	Move Title cursor to the right.
		Insert	Insert one character.
		Delete	Delete one character.
		Clear	Clear Title.
		return	

Title Edit Screen

# SOUND Monitor

The spectrum analyzer has a SOUND monitor function which demodulates an AM or FM modulated signal so that the sound can be listened to using the built-in speaker.

To listen to the sound, first set the center frequency to the receiving frequency, then set the display mode to the time domain mode. Second, perform the following key operations, depending on the modulation system.

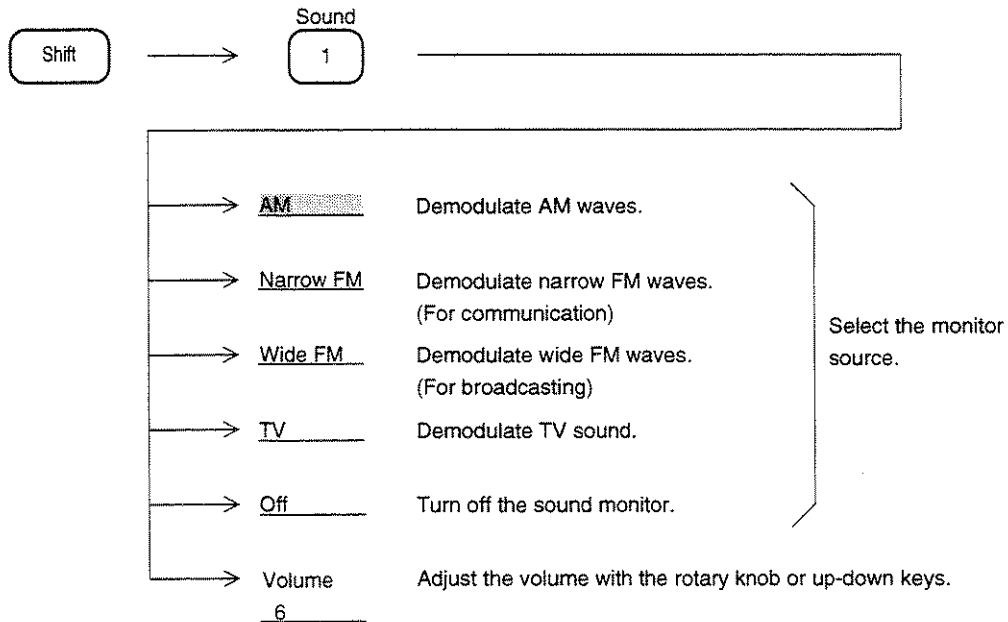

**Note:** In spite of setting the center frequency to the desired receive frequency, the sound may not be able to be monitored, correctly, because of the RBW center-frequency error calibration. In this case, turn off the RBW center-frequency error calibration, as shown below.

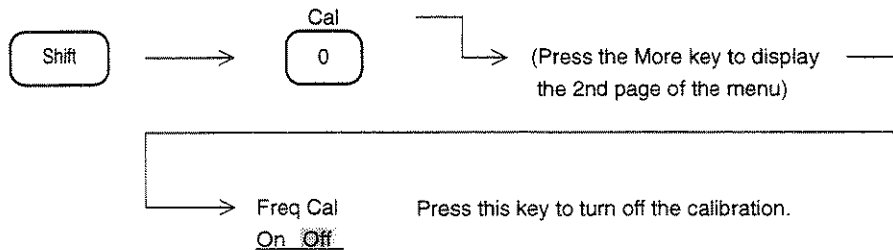

When Freq Cal turned Off, the displayed waveform moves by the error amount. When the Sound Monitor is not used, turn On the Freq Cal.

## AM Wave Sound Monitor

Since the spectrum analyzer is not equipped with the AGC circuit that is used in general AM receivers, the reference level must first be set to the optimum value depending on the receiving level.

In the time domain display (linear scale) mode, set the reference level so that the waveform shown below is displayed.

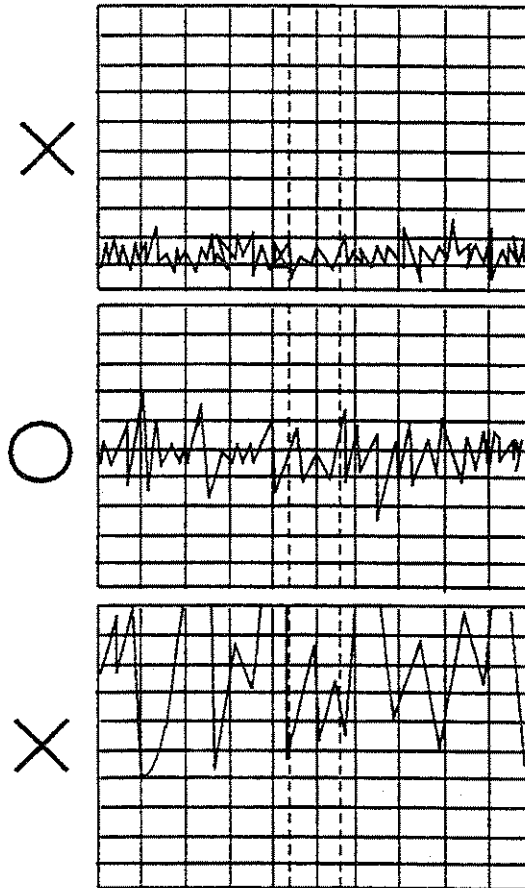

## FM Wave Sound Monitor

An FM wave is different from an AM wave in that the sound output level is not changed by the input level. When compared to the reference level, a too low input level results in deterioration of the S/N ratio. Therefore, the input level should be set so that it is preferably equal to the reference level.

## TV Image Monitor

The received TV picture by TV antenna dec. can be monitored on the screen by performing the following key operations.

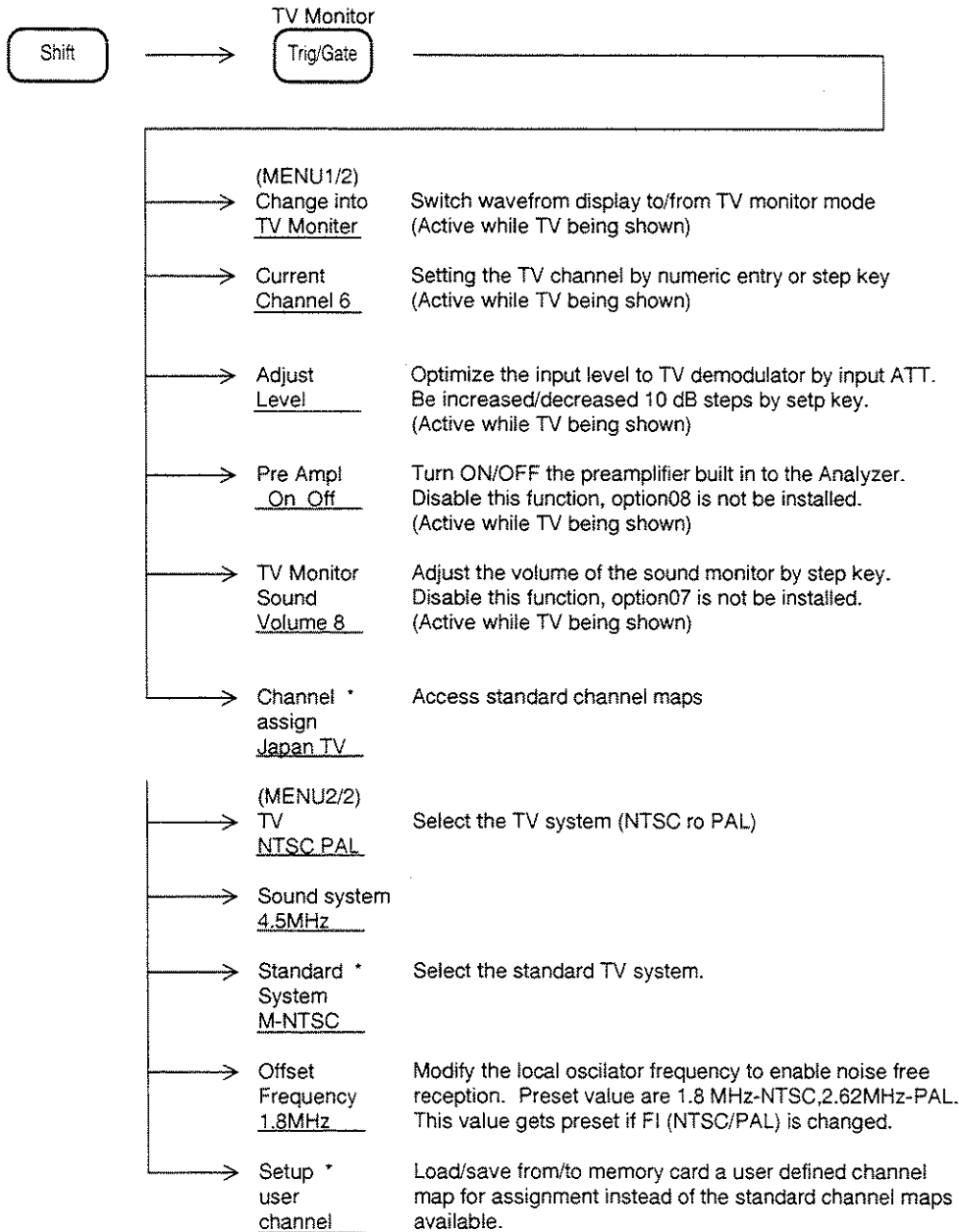

Note of key operation of the TV image monitor

- 1) An asterisk (\*) sign at the right extreme of the menu item title indicates existence of a sub-menu under the item. It may or may not be accessible depending on the selection of other menu items.
- 2) Function keys other than the ones indicates as "(Active while TV being shown) are inactive after the display is switched to TV Monitor mode.
- 3) While display is in TV monitor mode **Frequency** key followed numeric entry can set channel directly and when followed by step key allows single channel increment/decrement.
- 4) While display is in TV monitor mode **Amplitude** key followed by step key allows signal level to be raised or lowered by taking input, attenuator and preamplifier though a pre-programmed sequence. (Preamplifier ON and 0 dB ATT, Preamplifier ON and 10 dB ATT, Preamplifier ON and 20 dB ATT, Preamplifier OFF and 0 dB ATT, Preamplifier OFF and 10 dB ATT, Preamplifier OFF and 20 dB ATT, Preamplifier OFF and 30 dB ATT etc. with attenuator changing in 10 dB steps.)

■ Channel map and countries covered by them

MS2650/MS2660 Channel assign	TV System	Countries
CCIR TV CCIR CATV	B/G/H PAL	Austria, Belgium, Denmark, Finland, Germany, Netherlands, Norway, Portugal, Spain, Sweden, Switherland, X-yugo, Afganistan, Algeria, Bahrain, Bangaladesh, Brunei, Cyprus, Ethiopia, India, Israel, Kuwait, Malta, Malaysia, Moldives, Oman, Pakisthan, Sierra-Leone, Singapore, Srilanka, Sudan, Tanzania, Thailand, Ugande, UAE, Yemen, Zimbabwe
US TV US CATV	M-NTSC	USA, Canada, Bahamas, Barbados, Bermuda, Bolivia, Mymmar, Cambodia, Chile, Colombia, Costa_Rica, Cuba, El_salvador, Equador, Greenland, Guam, Guatemala, Haiti, Hawaii, Honduras, S_Korea, Mexico, Micronesia, Midway_island, Netherlands_antilles, Panama, Phillippines, Puerto_Rico, Saint_Lucia, Samoa, Venezula, Vergin_islands
UK TV	IPAL	UK, Hong_Kong
ITALY TV	B/G/H PAL	Italy, Albania, San_Marino
CHINA TV	DPAL	China
JAPAN TV JAPAN CATV	M-NTSC	Japan

Transmission standard of TV can be selected by the "Standard System" button of the software menu.



### ■ "USER" Channel

Following is a sample internal program for generating a table of channel numbers and their corresponding picture frequency to enable the user adapt the system to show only the channels in actual use at his place by defining them in to User defined TV/User defined CATV. It can be also be used to set channel assignment others than the standard charts provided. Please note that it is possible to SAVE/LOAD this table to memory card.

```

10 DIM FREQ$(20)
20 DIM CMD$(50)
30 *START
40 INPUT"SELECT 1:USER-TV OR 2:USER-CATV",SYS
50 IF SYS=1 GOTO *USERTV
60 IF SYS=2 GOTO *USERCATV
70 GOTO *START
80 *USERTV
90 PRINT"INPUT CH.NO,PICTURE FREQ(MHZ)(0,0,IS STOP)"
100 INPUT CH$,FREQ$
110 IF CH$="0" GOTO *EXIT
120 IF VAL(CH$)<1 GOTO *ERRDISP
130 IF VAL(CH$)>99 GOTO *ERRDISP
140 IF VAL(FREQ$)<40.0000 GOTO *ERRDISP
150 IF VAL(FREQ$)>900.0000 GOTO *ERRDISP
160 CMD$="USRTVDEF"+CH$+", "+FREQ$+"MHZ"
170 PUT CMD$
180 GOTO *USERTV
190 *USERCATV
200 PRINT "INPUT" CH,NO,PICTURE FREQ(MHZ)(0,0 IS STOP)"
210 INPUT CH$,FREQ$
220 IF CH$="0" GOTO EXIT
230 IF VAL(CH$)<1 GOTO *ERRDISP
240 IF VAL(CH$)>99 GOTO *ERRDISP
250 IF VAL(FREQ$)<40.0000 GOTO *ERRDISP
260 IF VAL(FREQ$)>900.0000 GOTO *ERRDISP
270 CMD$="USRCATVDEF"+CH$+", "+FREQ$+"MHZ"
280 PUT CMD$
290 GOTO *USERCATV
300 *ERRDISP
310 PRINT "Data out of range"
320 IF SYS=1 GOTO *USERTV
330 IF SYS=2 GOTO *USERCATV
340 *EXIT
350 STOP

```

### ■ Adjusting Brightness of display for comfortable viewing

It should be noted that degree brightness for comfortable viewing varies with the vertical angle of viewing for LCD typw displays.

Refer section 9 for details.

# SECTION 12

## PTA/DEFINE FUNCTIONS

This section describes the PTA function which uses the spectrum analyzer as the controller and the define function which allows definition of PTA automatic measurement program execution, etc. by user key.

### TABLE OF CONTENTS

PTA Program Editing and Loading .....	12-3
Setting PTA Program .....	12-3
Loading and Executing PTA Program .....	12-4
Loading and Executing Library Program .....	12-5
User-Definition Function .....	12-6
Defining User Menu .....	12-7
Example of User-Definition Operation .....	12-8

# SECTION 12 PTA/DEFINE FUNCTIONS

## PTA Program Editing and Loading

Input and edit the PTA program by external computer editor by PTL language (BASIC-like interpreter). For further details, refer to the operating instructions of the PTA Control part.

Load the edited program to the spectrum analyzer program memory (192 kilobytes) via the RS-232C/GPIB interface or a memory card.

The measurement data can be directly accessed as variables by system variable, system subroutine, and system function.

### Setting PTA Program

To set a PTA program and library, perform the following key operation.

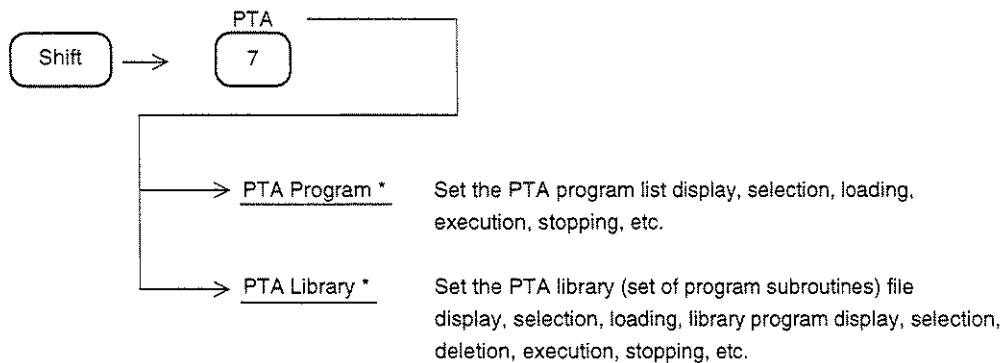

## Loading and Executing PTA Program

To load and execute a PTA program, perform the following key operations.

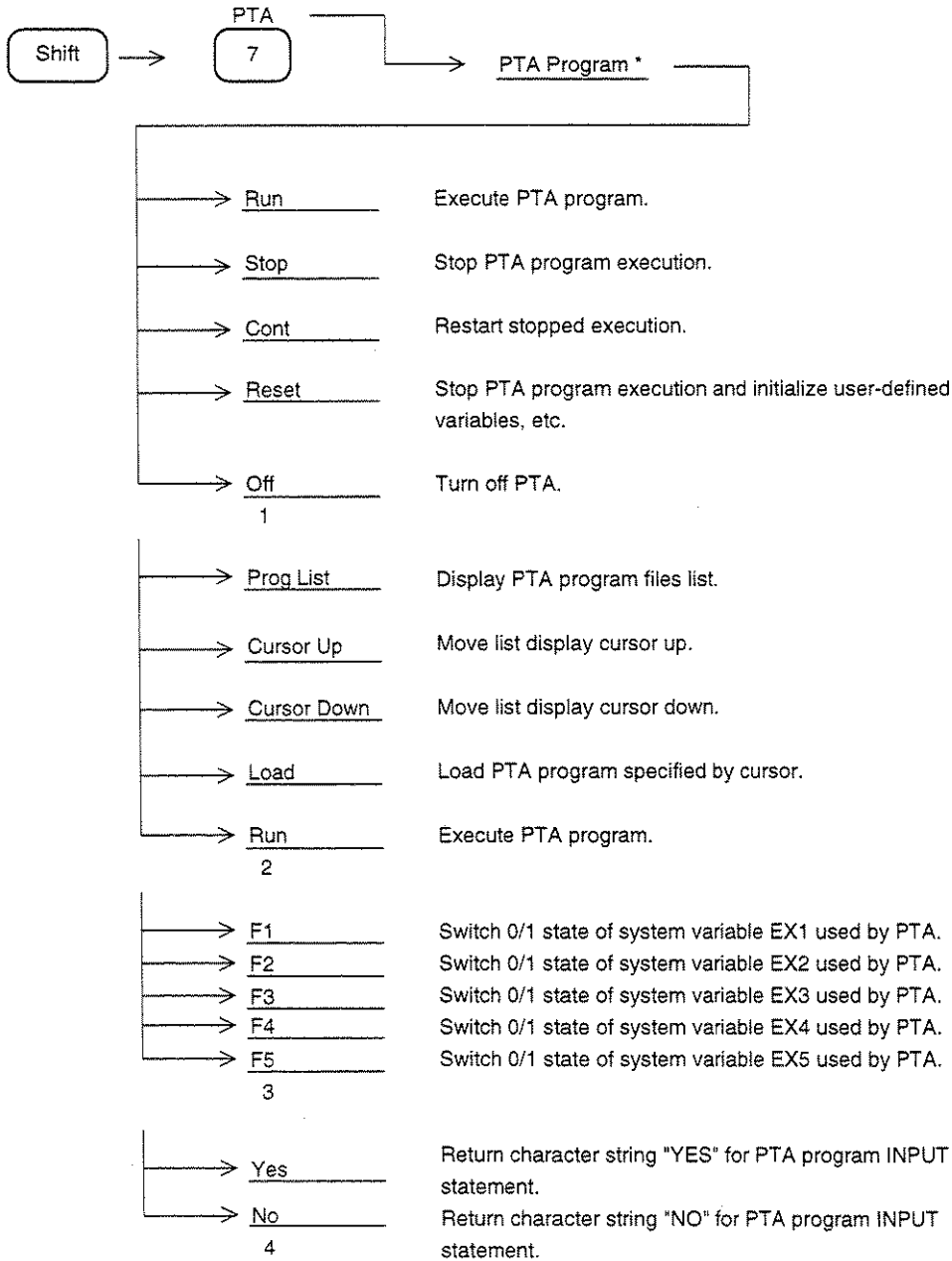

# Loading and Executing Library Program

To load and execute a library program, perform the following key operations.

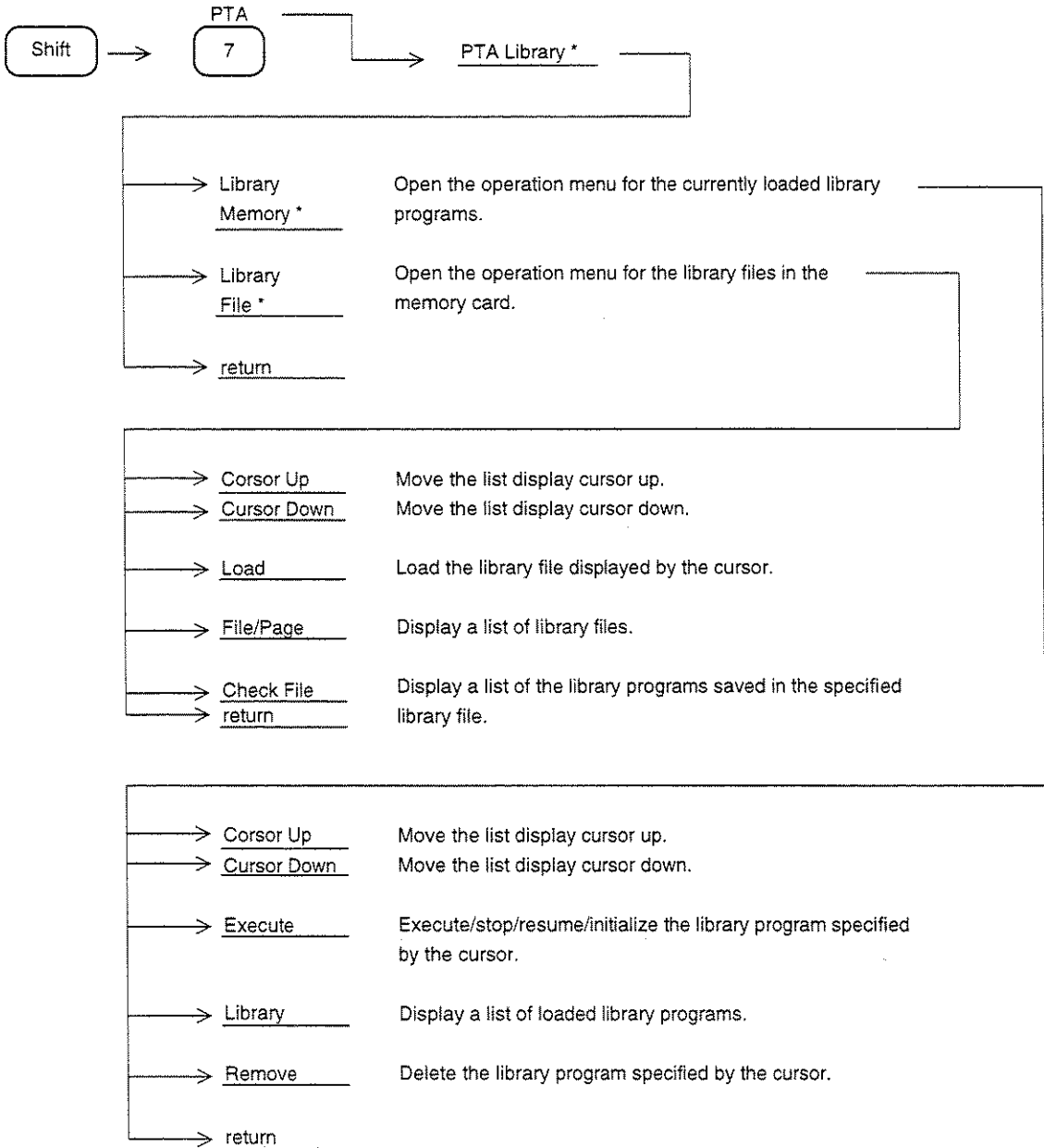

## User-Definition Function

This paragraph describes the define function that allows definition of library program execution or normal key operation, etc. by user key.

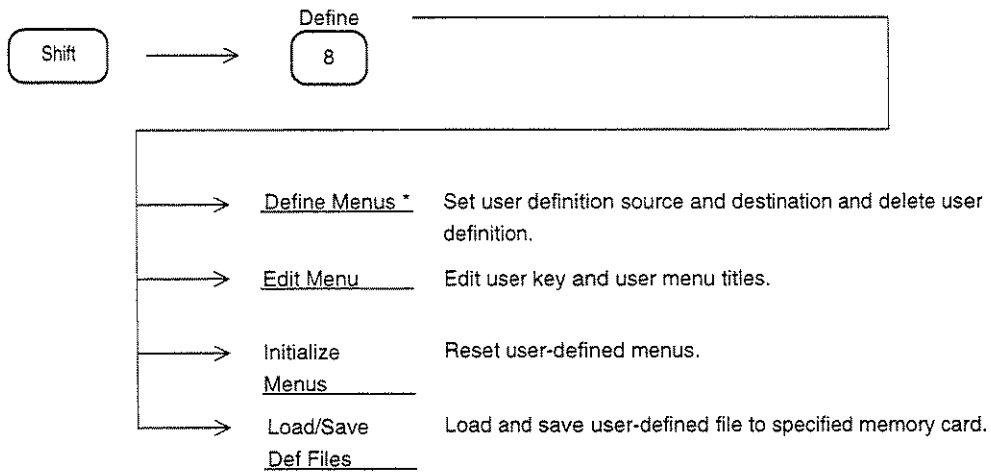

# Defining User Menu

To select the library programs or normal key operations, etc. that are frequently used and to define their function in the user keys, perform the following key operations.

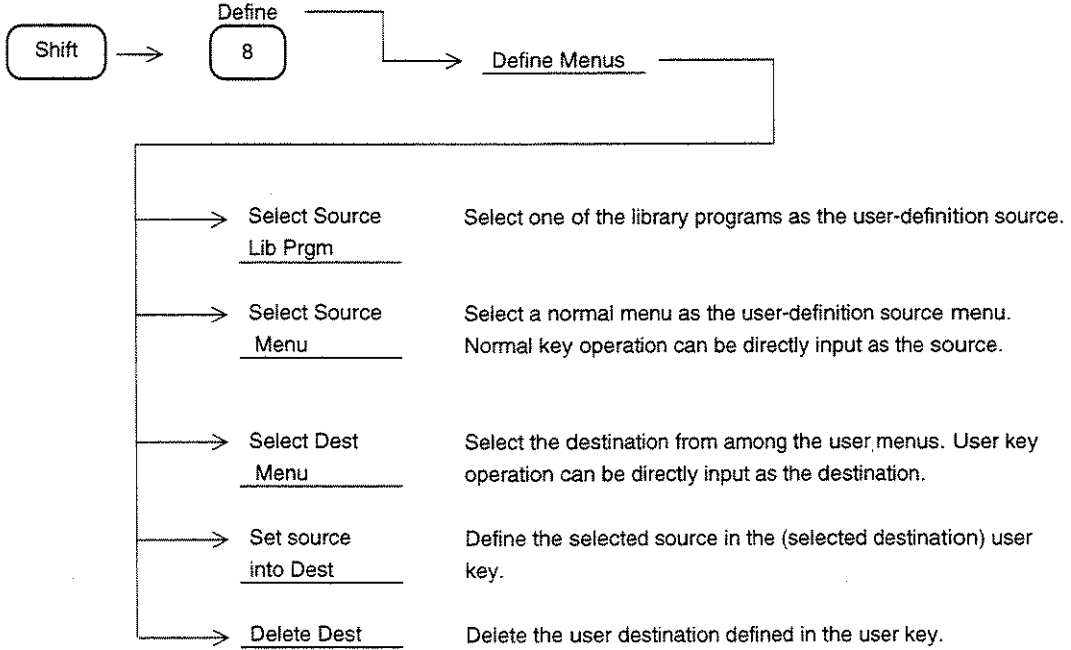

## Example of User-Definition Operation

To define the frequency count measurement function in the User1 F1 key, perform the following key operations.

The following also explains an example of key operation which makes the title of that key "Meas Freq".

- ① Select the source by " **Shift** **Define** Define Menu Select Source Menu" key operation.
- ② Set frequency count measurement start at the source by " **Measure** Frequency Count Count On" key operation.
- ③ Select the destination by " **Shift** **Define** Define Menu Select Dest Menu" key operation.
- ④ Set the User1 F1 key as the destination by " **User** **F1** " key operation.

Source	<b>Destination</b>
F1-Key	F1-Key
Freq Count	User-1
Count On	---

User Definition Screen Display

- ⑤ Execute user key definition by " **Shift** **Define** Define Menu Set source into Dest" key operation.
- ⑥ Perform " **Shift** **Define** Edit Menu Select Source" key operation and select the User1 F1 key by " **User** **F1** " key operation.



- ⑦ Perform **Shift** **Define** **Edit Menu** **Edit F-key menu** key operation and enter "Meas Freq" at the title edit screen shown below by rotary knob and soft key operation.

<p>Title: Meas Freq</p> <div style="border: 1px solid black; padding: 5px; margin: 10px 0;"> <p>ABCDEFGHIJKLMNOPQRSTUVWXYZ  abcdefghijklmnopqrstuvwxyz  0123456789-+*/=!"#\$\$%&amp;'()~  /   @ [ ] ( ) : ; , . &lt; &gt; ? _</p> </div> <p>Select the characters by turning the rotary knob.  After setting the title, press the [Return] key.</p>	<table border="1"> <thead> <tr> <th>Count On</th> <th>Edit</th> </tr> </thead> <tbody> <tr> <td>←</td> <td>Move Title cursor to the left.</td> </tr> <tr> <td>→</td> <td>Move Title cursor to the right.</td> </tr> <tr> <td>Insert</td> <td>Insert one character.</td> </tr> <tr> <td>Delete</td> <td>Delete one character.</td> </tr> <tr> <td>Clear</td> <td>Clear Title.</td> </tr> <tr> <td>return</td> <td></td> </tr> </tbody> </table>	Count On	Edit	←	Move Title cursor to the left.	→	Move Title cursor to the right.	Insert	Insert one character.	Delete	Delete one character.	Clear	Clear Title.	return	
Count On	Edit														
←	Move Title cursor to the left.														
→	Move Title cursor to the right.														
Insert	Insert one character.														
Delete	Delete one character.														
Clear	Clear Title.														
return															

Title Edit Screen

- ⑧ Press the **User** key and check if the following is displayed at the F1 function key. Also press the **User1** **F1** key and check if frequency measurement is performed.

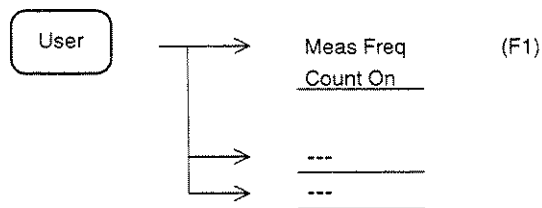

# SECTION 13

## MEASUREMENT

This section describes the Measure key and the operating procedure for actual measurement examples.

### TABLE OF CONTENTS

Measure Measurement Function .....	13-3
Frequency Measurement Function .....	13-4
Measuring Noise Power .....	13-4
Measuring C/N Ratio .....	13-4
Channel Power .....	13-5
Measuring Occupied Bandwidth .....	13-5
Measuring Adjacent Channel Leakage Power .....	13-6
Pass/Fail Judgment by Mask .....	13-6
Pass/Fail Judgment by Time Template .....	13-7
Measuring Burst Average Power .....	13-7
Measurement Examples .....	13-8
Example of C/N Ratio Measurement .....	13-8
Example of Power (Noise) Measurement (Frequency Domain, Continuous Wave) .....	13-10
Example of Channel Power Measurement .....	13-12
Example of Power Measurement (Time Domain) .....	13-14
Example of Time Domain Peak Detection .....	13-17
Example for Occupied Frequency Bandwidth (Burst Wave) .....	13-18
Example of Spurious Radiation Strength Measurement (Burst Wave) .....	13-20
Examples of Carrier-Off Leakage Power Measurement (Time Gate Spectrum Analysis) .....	13-23
Example of Measurement of Adjacent Channel Leakage Power .....	13-28
Example of Memory Card Use .....	13-30
Example of Time Template Creation (PHS Transmit Signal) .....	13-31
MASK Creation in Frequency Domain Mode .....	13-36

# SECTION 13 MEASUREMENT

## Measure Measurement Function

Various application measurements can be selected by performing the following key operations.

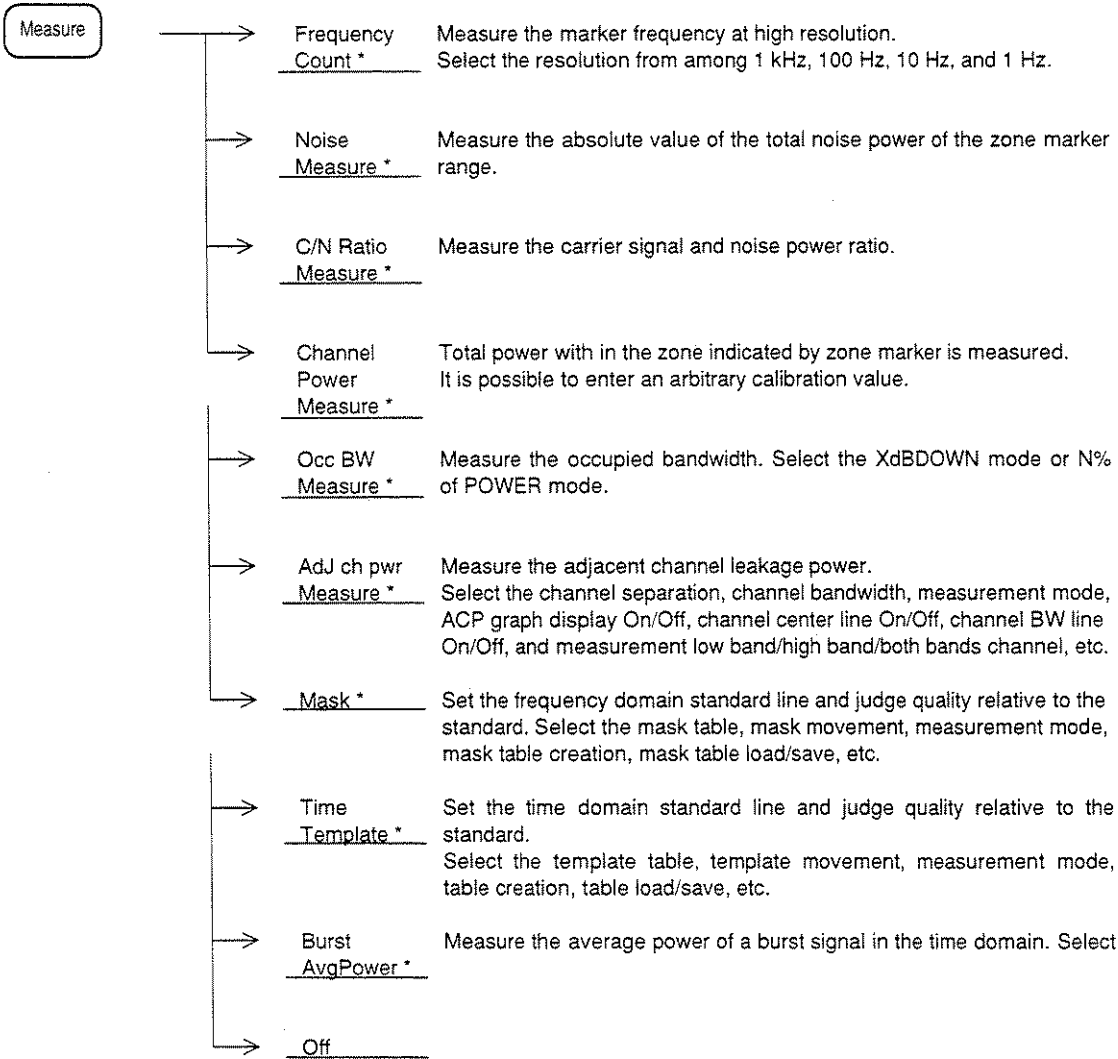

## Frequency Measurement Function

To measure the marker frequency at high resolution, perform the following key operations.

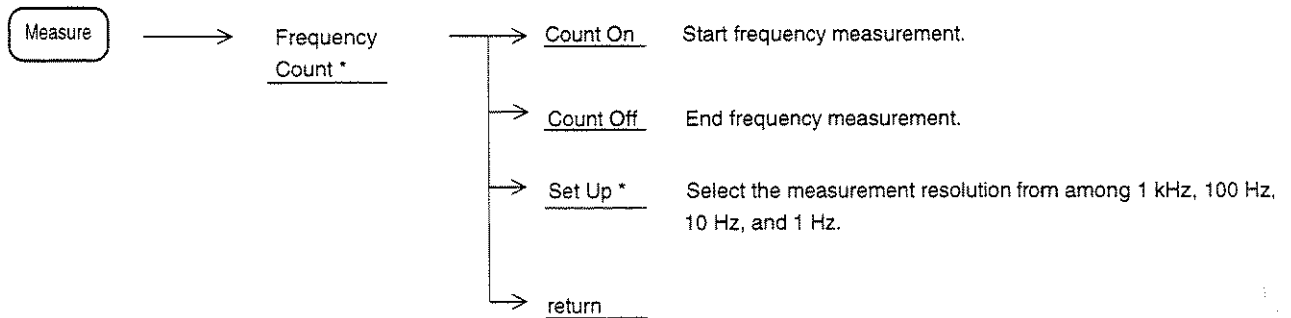

- Note:
- If the RBW is too small compared to frequency span, it takes more times to count because of the internal automatic tuning operation.  
Conversely, if the RBW is too large and another signal exists near the measurement signal (within the 20 multiple of the RBW), the automatic operation may catch it. So, select the appropriate RBW value.
  - In the following cases, the frequency may not be counted correctly because of the undesired adjacent noise.
    - ① Signal level is less than -30 dB from reference level.
    - ② Level difference between signal and noise is less than 20 dB.

## Measuring Noise Power

To measure the total noise power of the zone marker range, perform the following key operations.

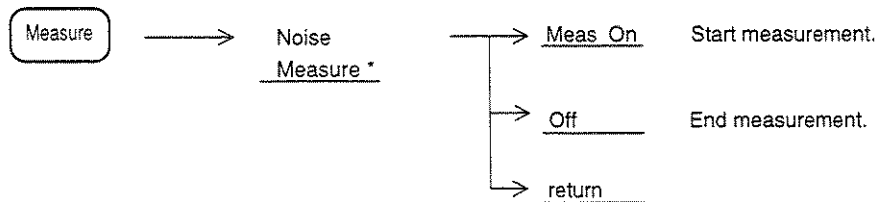

## Measuring C/N Ratio

To measure the C/N ratio, perform the following key operations.

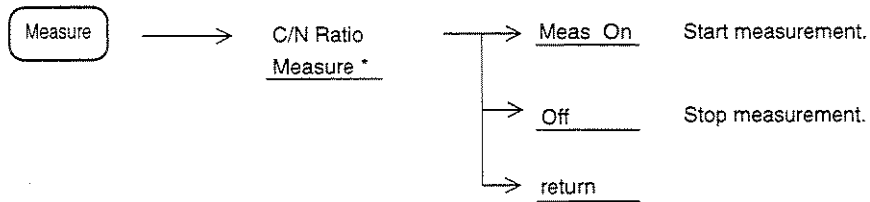

## Channel Power

Total power with in the channel specified by zone marker is measured.  
It is possible to set an arbitrary calibration value.

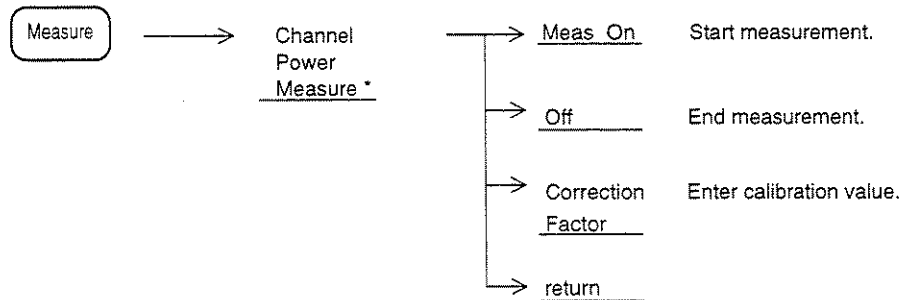

## Measuring Occupied Bandwidth

To measure the occupied bandwidth, perform the following key operations.

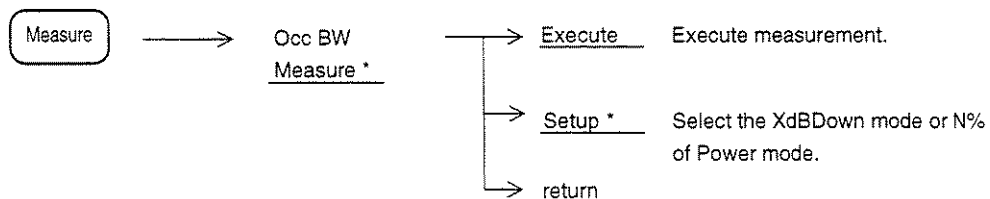

## Measuring Adjacent Channel Leakage Power

To measure the adjacent channel leakage power, perform the following key operations.

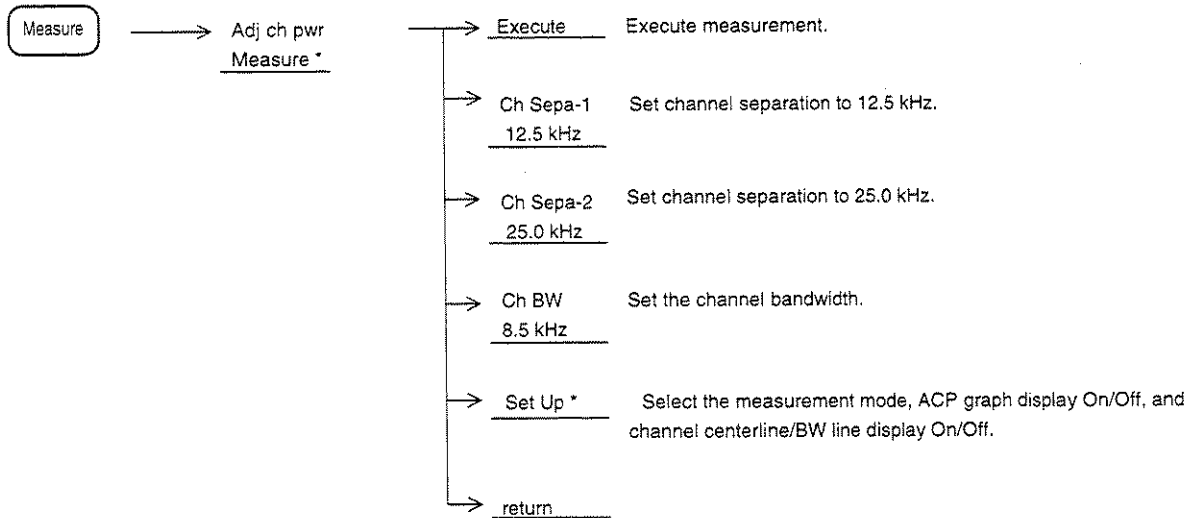

## Pass/Fail Judgment by Mask

To perform pass/fail judgment relative to the frequency domain standard line (mask), perform the following key operations.

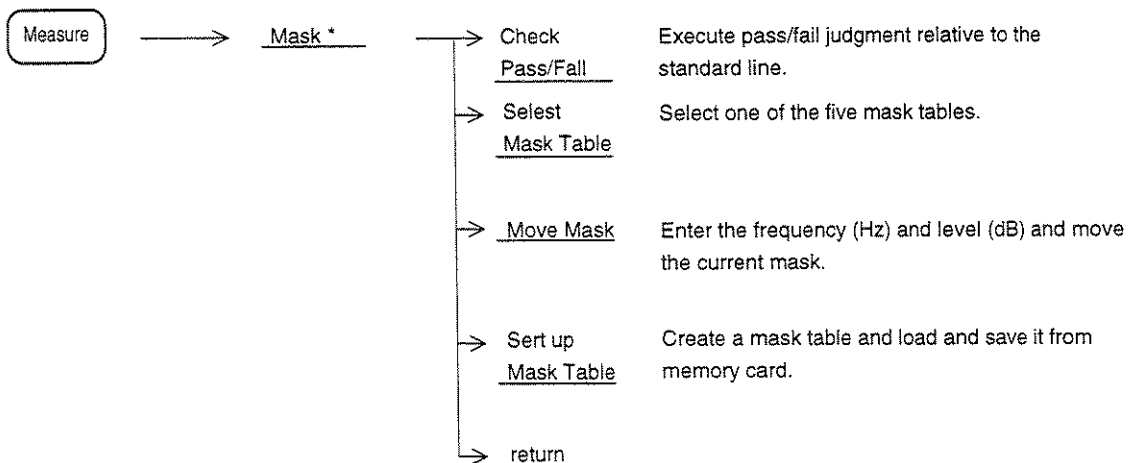

## Pass/Fail Judgment by Time Template

To perform pass/fail judgment by time domain template, perform the following key operations.

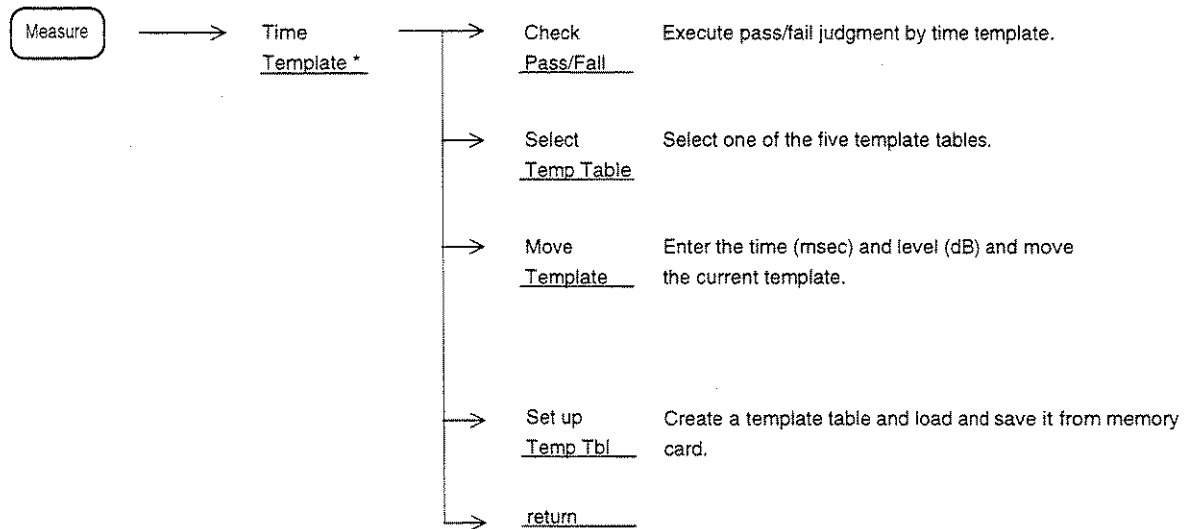

## Measuring Burst Average Power

To measure the average power of a burst wave in the time domain mode, perform the following key operations.

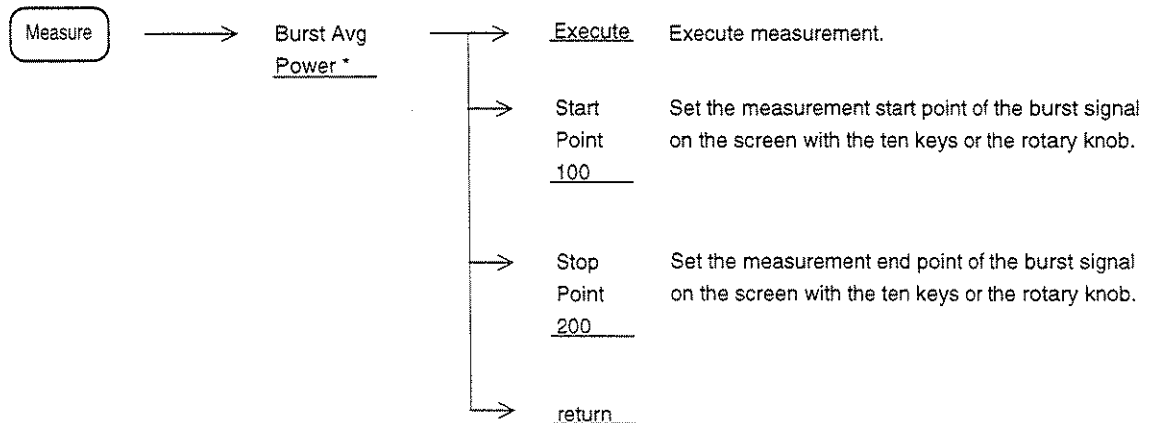

## Measurement Examples

The following describes the measurement block diagram and measurement operating procedure of actual measurement examples.

In the measurement examples, [ ] indicates a panel key and F\*: << >> indicates a soft key.

### Example of C/N Ratio Measurement

- In C/N measurement, set the detection mode set to the Sample mode, unless specified otherwise. (Pressing [A,B] until F1: <<Trace A>> is displayed, then set the mode by pressing F1: <<Trace A>>, F6: <<Detection>>, and F3: <<Sample>>.)

#### (1) Measurement block diagram

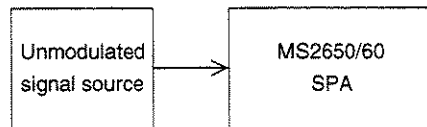

- Center frequency : 1.9 GHz
- Offset frequency : 100 kHz

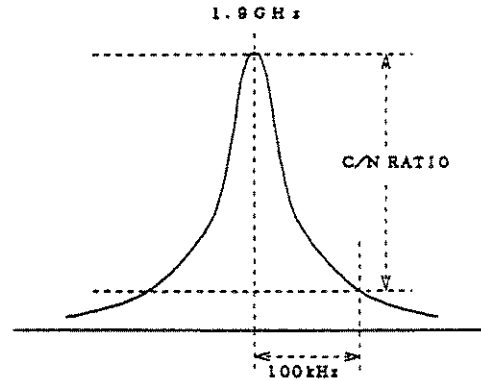

#### (2) Measurement procedure

Step	Procedure
1	[Preset], F1: <<Preset All>>
2	Span frequency setting : [Span], [4]m [0], [0], [kHz] Set to 3 or 4 times the offset frequency. (Here, the span frequency was set to 400 kHz.)
3	Reference level setting : [Amplitude], [2], [0], [dBm]
4	Center frequency setting: [Frequency], [1], [.] [9], [GHz]
5	RBW setting : [RBW], [3], [kHz]
6	Marker setting : [Marker], F5: <<Zone Width>>, F1: <<Spot>>
7	Peak (frequency, level) setting: After 1 sweep, press [→CF] and [→RLV].
8	Marker position setting : [Marker], F2: <<Delta Marker>>, [1], [0], [0], [kHz] (Becomes the offset frequency.)
9	C/N ratio measurement: : Press [Measure] until F3: <<C/N Ratio Measure>> is displayed, then press F3: <<C/N Ratio Measure>> and F1: <<Meas On>>. Each time sweep is refreshed, the measurement result is displayed at the upper left-hand corner of the screen.



- ★ Measurement result example:  $-119.14$  dBc/Hz
- ★ When wanting to change the offset frequency and make measurement: Press [Marker], then set the offset frequency with the rotary knob or ten keys.
- ★ Change the RBW value and select the best C/N measurement value. Also make the ATT value minimum.

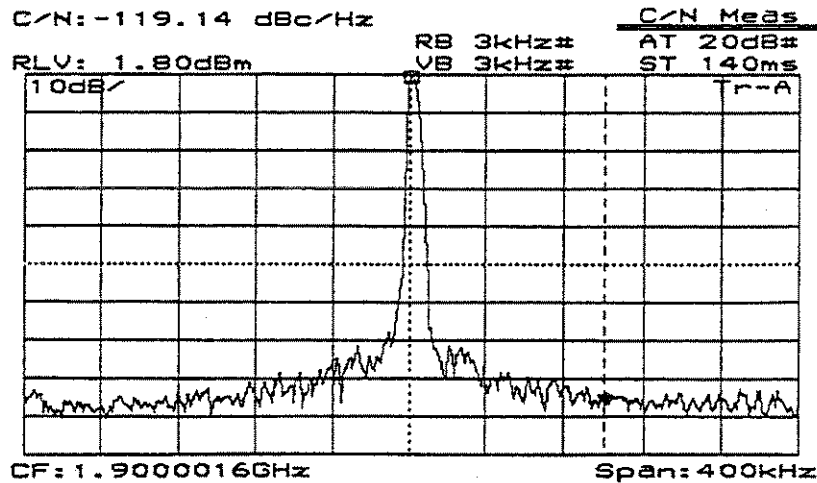

Example of C/N Ratio Measurement

- Note:
- When the marker frequency is moved at the reference marker point(peak point of the carrier signal), the measurement result does not become 0 dB.  
This is because the carrier signal(on which the reference marker is positioned) is considered as a noise, and the detector adds the correction value to the carrier.

## Example of Power (Noise) Measurement (Frequency Domain, Continuous Wave)

- When making power measurements, set the detection mode to the Sample mode, unless specified otherwise. When measuring the carrier-off leakage power and adjacent channel leakage power of Japan digital cordless telephone systems (burst wave), set the detection mode to the Pos Peak mode.

### (1) Measurement block diagram

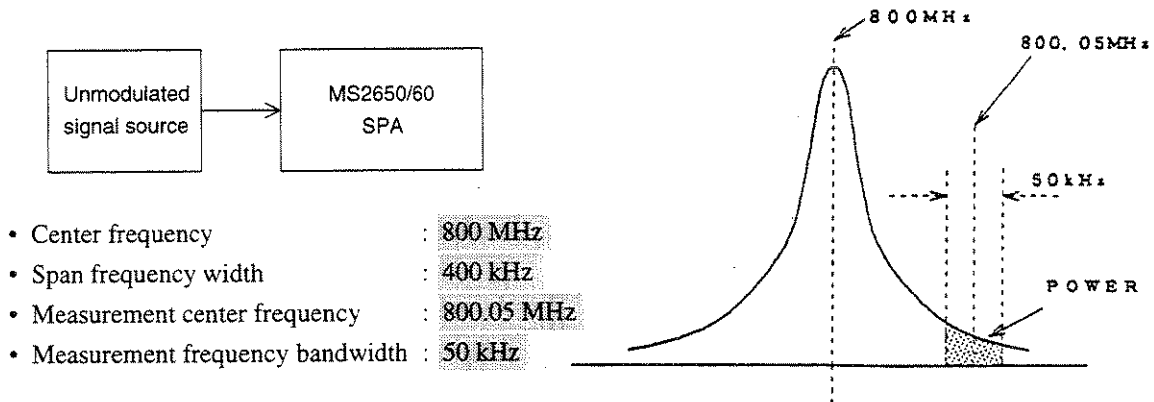

### (2) Measurement procedure

Step	Procedure
1	[Preset], F1: <<Preset All>>
2	Span frequency setting : [Span], [4], [0], [0], [kHz]
3	Reference level setting : [Amplitude], [2], [0], [dBm]
4	Center frequency setting : [Frequency], [8], [0], [0], [MHz]
5	RBW setting : [RBW], [3], [kHz]
6	Peak(frequency, level) setting: After 1 sweep, press [→CF] and [→RLV].
7	Zone center position setting : [Marker], F5: <<Zone Width>>, F1: <<Spot>>, [Marker], F1: <<Normal Marker>>, [8], [0], [0], [1], [0], [5], [MHz]
8	Zone marker width setting : [Marker], F5: <<Zone Width>>, [5], [0], [kHz]
9	Measure power(noise) : Press [Measure] until F2<< Noise Measurement>> is displayed, then press F2: <<Noise Measure>> and F1: <<Meas On>>. Each time sweep is refreshed, <u>the total power value of the zone marker range</u> (measured value) is displayed at the upper left-hand corner of the screen.

- ★ Measurement result example: -70.81 dBm/ch
- ★ When wanting to change the zone marker position and make measurements: After pressing [Marker], set the position (frequency) with the ten keys.
- ★ Applications: \* Carrier-off leakage power (PHS) measurement  
\* Adjacent channel leakage power (PHS) measurement

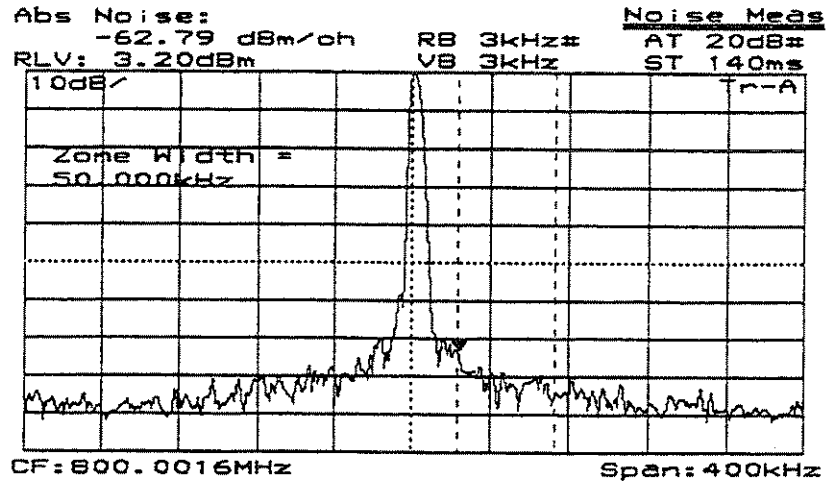

Example of Power (Noise) Measurement

## Example of Channel Power Measurement (Frequency Domain, Continuous Wave)

- When making power measurements, set the detection mode to the Sample mode, unless specified otherwise. When measuring the carrier-off leakage power and adjacent channel leakage power of Japan PHS systems (burst wave), set the detection mode to the Pos Peak mode.

### (1) Measurement block diagram

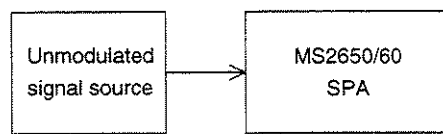

- Center frequency : 800 MHz
- Span frequency width : 400 kHz
- Measurement center frequency : 800.05 MHz
- Measurement frequency bandwidth : 50 kHz

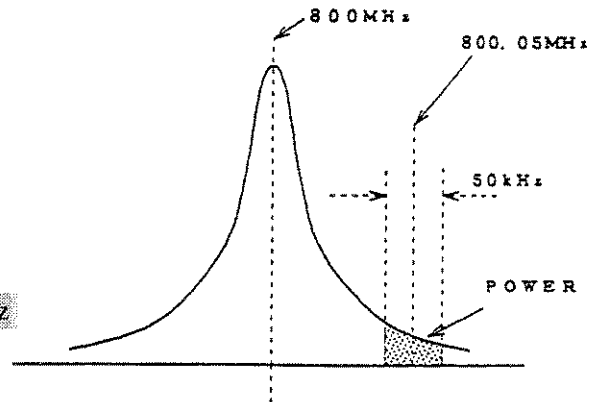

### (2) Measurement procedure

Step	Procedure
1	[Preset], F1: <<Preset All>>
2	Span frequency setting : [Span], [4], [0], [0], [kHz]
3	Reference level setting : [Amplitude], [2], [0], [dBm]
4	Center frequency setting : [Frequency], [8], [0], [0], [MHz]
5	RBW setting : [RBW], [3], [kHz]
6	Peak(frequency, level) setting: After 1 sweep, press [→CF] and [→RLV].
7	Zone center position setting : [Marker], F5: <<Zone Width>>, F1: <<Spot>>, [Marker], F1: <<Normal Marker>>, [8], [0], [0], [1], [0], [5], [MHz]
8	Zone marker width setting : [Marker], F5: <<Zone Width>>, [5], [0], [kHz]
9	Measure Channel Power : Press [Measure] until F4<< Channel Power measure>> is displayed, then press F4: <<Noise Measure>> and F1: <<Meas On>>.

Each time sweep is refreshed, the total power value of the zone marker range (measured value) is displayed at the upper left-hand corner of the screen.

F5: <<correction factor>> , an arbitrary calibration value can be entered.

- ★ Measurement result example:  $-70.81$  dBm,  $-152.72$  dBm/Hz
- ★ When wanting to change the zone marker position and make measurements: After pressing [Marker], set the position (frequency) with the ten keys.

## Example of Power Measurement (Time Domain)

- Find the effective average value of the zone set by the two cursors on the screen.

### (1) Measurement block diagram

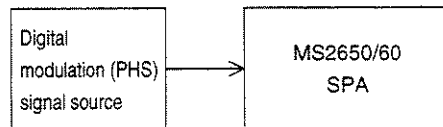

- Center frequency : 1.9 GHz
- Time span : 1 ms

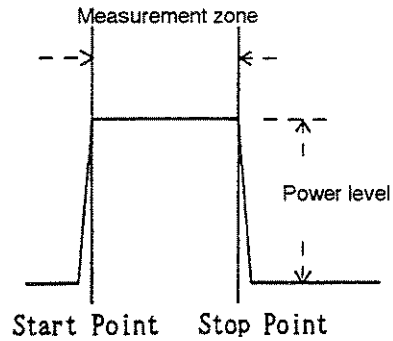

### (2) Measurement procedure

Step	Procedure
1	[Preset], F1: <<All>>.
2	Time domain : [Time] or [Span], [0], [Hz]
3	Reference level setting : [Amplitude], [2], [0], [dBm]
4	Center frequency setting : [Frequency], [1], [1], [9], [GHz]
5	RBW setting : [RBW], [1], [MHz]
6	VBW setting : [VBW], [1], [MHz]
7	Time span setting : [Time], F2: <<Time Span>>, [5], [msec]
8	Reference level setting : After one sweep, press [->RLV] and [Amplitude] and raise the reference level about 3 dB with the rotary knob.
9	Time span setting : [Time], F2: <<Time Span>>, [1], [msec]
10	Trigger setting : Select Triggered with [Trig/Gate], F1: <<Trigger>>. F2: <<Trigger Source>>, F1: <<Video>> (Apply <u>video trigger</u> ) Select rise with F5: <<Trig Slope>>. Press F1: <<Trig Level>>, then set the trigger level with the rotary knob.
11	Time delay setting : Press [Trig/Gate], F5: <<Delay Time>>, then set the signal waveform to the left of center of the screen with the rotary knob.

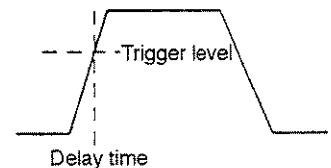

Step	Procedure
12	Single sweep : [Single]
13	Measurement preparation : Press [Measure] until F2: <<Burst Avg Power>> is displayed, then press F2: <<Burst Avg Power>>. Measurement zone setting : Press F3: <<Start Point>>, then set the measurement zone start position with the rotary knob. Press F2: <<Stop Point>>, then set the measurement zone stop position with the rotary knob.
14	Power measurement : F1: <<Execute>>. The measured value is displayed at the top left-hand corner of the screen.

★ Example of measurement result: -16.84 dBm, 20.7 μ W

★ When finding the average power between burst frames, measurement should be performed by setting the measurement zone to the burst frame time.

- ★ Applications: \* Spurious radiation strength measurement (PDC, PHS)
- \* Antenna power measurement (PDC, PHS)

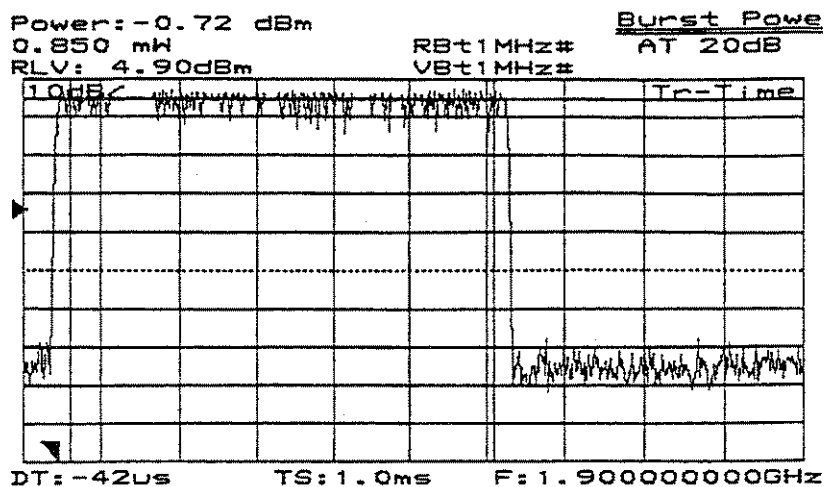
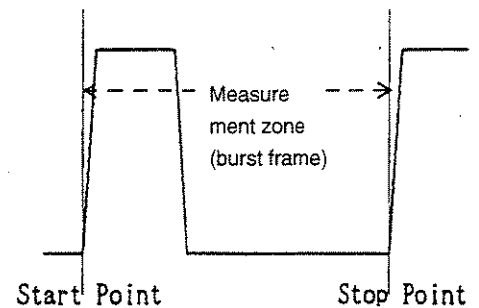

Power Measurement (Time Domain) Example 1

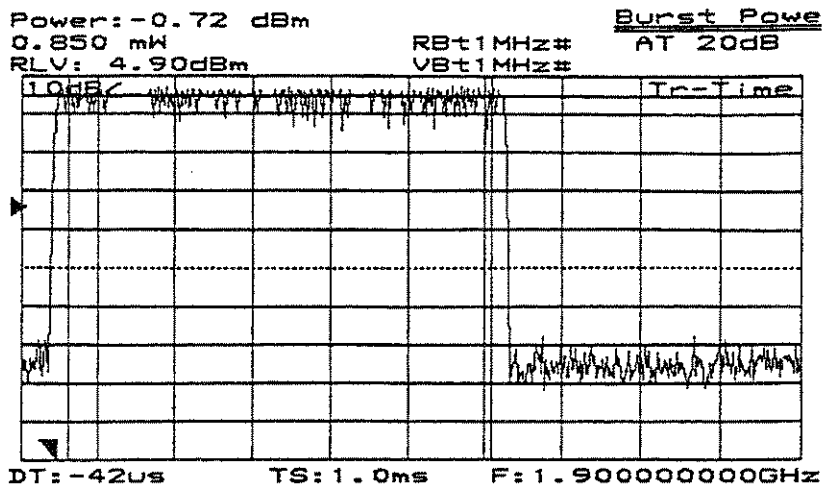

Power Measurement (Time Domain) Example 2



## Example of Time Domain Peak Detection

- The time domain detection mode is initially set to the sample detection mode. When the time axis sweep time was set to more than 20 ms, the positive peak detection mode can be selected.

### (1) Measurement block diagram

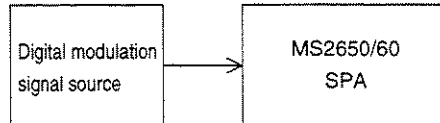

- Center frequency : 1.9 GHz
- Time span : 20 ms

### (2) Measurement procedure

Step	Procedure
1	Set in accordance with steps 1 to 9 of the power measurement procedure of paragraph 5 Power Measurement (Time Domain). Set <<Time Span>> of step 7 to 20 ms.
2	DET MODE menu display : Press [Time] until F6: <<Detection>> is displayed. Select F6: <<Detection>>, F2: <<Pos Peak>>.

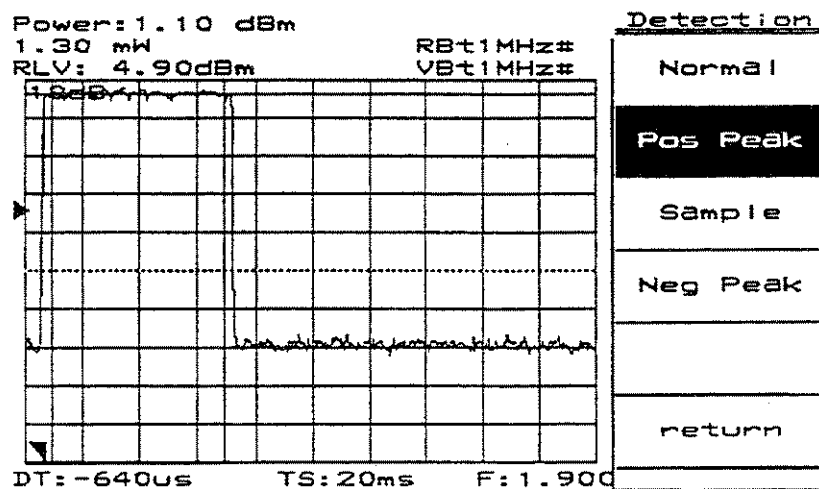

Example of Positive Peak Detection Mode

## Example for Occupied Frequency Bandwidth (Burst Wave)

- For burst waves, set the detection mode to the Pos Peak mode.

### (1) Measurement block diagram

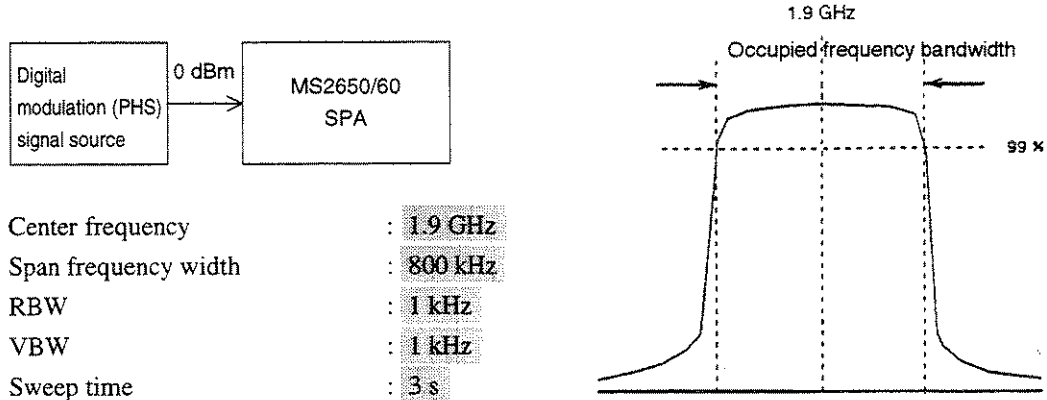

- Center frequency : 1.9 GHz
- Span frequency width : 800 kHz
- RBW : 1 kHz
- VBW : 1 kHz
- Sweep time : 3 s

### (2) Measurement procedure

Span	Procedures
1	[Preset], F1: <<Preset All>>
2	Span frequency setting : [Span], [8], [0], [0], [kHz]
3	Reference level setting : [Amplitude], [0], [dBm]
4	Center frequency setting : [Frequency], [1], [1], [9], [GHz]
5	RBW setting : [RBW], [1], [kHz]
6	VBW setting : [VBW], [1], [kHz]
7	Sweep time setting : [Sweep Time], [3], [s]
8	Single sweep : [Sweep]
9	Measurement preparation : Press [Measure] until F1: <<Occ BW Measure>> is displayed, then press F1: <<Occ BW Measure>>.
10	99% method setting : Select N% of Pwr with F5: <<Setup>>, F1: <<Method>>. F2: <<N% Ratio>>, [9], [9], [Enter]
11	Occupied frequency bandwidth method: F6: <<Return>>, F1: <<Execute>>. The measured value is displayed at the top left-hand corner of the screen.

- ★ Example of measurement result: OccBW: 245 kHz, CTR: 1.899996 GHz
- ★ Application: Occupied frequency bandwidth (PDC, PHS, etc.)

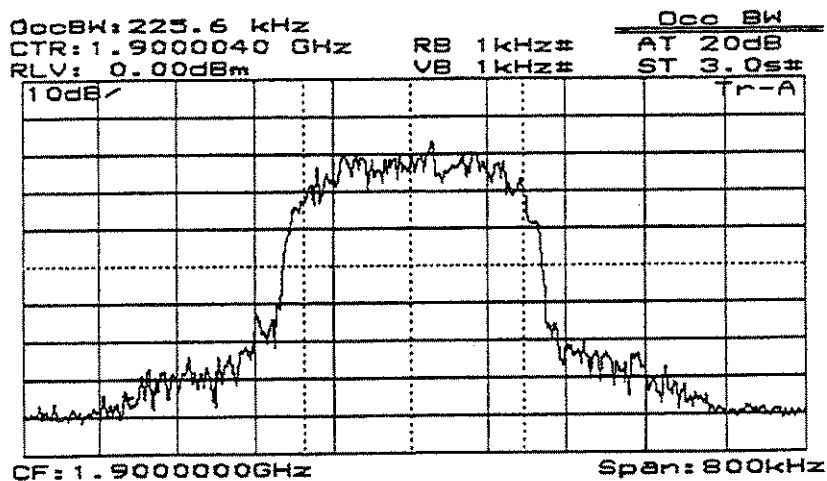

Example of Occupied Frequency Bandwidth Measurement

## Example of Spurious Radiation Strength Measurement (Burst Wave)

- For burst waves, set the detection mode to the Pos Peak mode.

### (1) Measurement block diagram

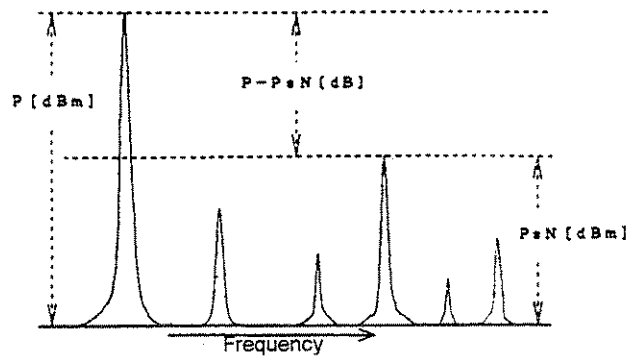
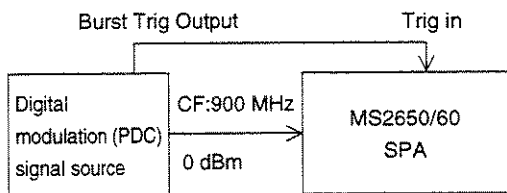

#### Detection:

- Sweep frequency range : 10 MHz to 3 GHz
- RBW : 1 MHz
- VBW : 1 MHz
- Sweep time : 60 s

#### Power measurement:

- Span frequency width : 0 Hz
- RBW : 100 kHz
- VBW : 10 kHz
- Sweep time : 20 ms

### (2) Measurement procedure

Step	Procedure
(A) Spurious detection	
1	[Preset], F1: <<Preset All>>.
2	Sweep frequency range setting : [Frequency], F3: <<Start Freq>>, [1], [0], [MHz], F3: <<Stop Freq>>, [3], [GHz]
3	Reference level setting : [Amplitude], [5], [dBm]
4	RBW setting : [RBW], [1], [MHz]
5	VBW setting : [VBW], [1], [MHz]
6	Sweep time setting : [Sweep Time], [6], [0], [s]
7	Single sweep : [Single]

Step	Procedure
8	Multimarker setting : [Shift], [Marker] (Multi Mkr), F2: <<Highest 10>>, F5: <<Marker List>>. Main and spurious lists (frequency and level of each) are displayed.
	(B) Spurious radiation strength measurement (Example: Assume that the frequency obtained from the list is 1.8 GHz.)
9	Time domain: [Marker], F3: <<Marker Off>>, [Time]  <u>The following measures the power by the same procedure as power measurement (time domain).</u>
10	Center frequency setting : [Frequency], [1], [.] , [8], [GHz]
11	RBW setting : [RBW], [1], [0], [0], [kHz]
12	VBW setting : [VBW], [1], [0], [kHz]
13	Press pressing : [Time] until F2: <<Time Span>> is displayed, then press F2: <<Time Span>>, [2], [0], [ms].
14	Trigger setting : Select Triggered with [Trig/Gate], F1: <<Trigger>>. Select Rise with F2: <<Trigger Slope>>, F3: <<External>>, F1: <<-10 to 10V>>, F5: <<Trig Slope>>. F4: <<Trig Level>>, [2], [V]
15	Press : [Trig/Gate], F5: <<Delay Time>>, then set Delay Time with the rotary knob so that the signal waveform moves to the left of center of the screen.
16	Single sweep : [Single]
17	Measurement preparation : Press [Measure] until F2: <<Burst Avg Power>> is displayed, then press F2: <<Burst Avg Power>>.
18	Measurement zone setting : Press F3: <<Start Point>>, then set the measurement zone start position with the rotary knob. Press F4: <<Stop Point>>, then set the measurement zone stop position with the rotary knob.
19	Power measurement : F1: <<Execute>>. The measured value ( $P_{SN}$ ) is displayed at the top left-hand corner of the screen.

★Example of measurement result: -57.05 dBm, 1.97  $\mu$  W

Step	Procedure
	(C) Spurious ratio strength ratio (relative to carrier power)
20	Set the center frequency to the carrier frequency and measure the carrier power (P) by executing steps 15, 16, 17, and 18.
	Spurious radiation strength ratio: $(P_{SN}) - (P)$ [dB]

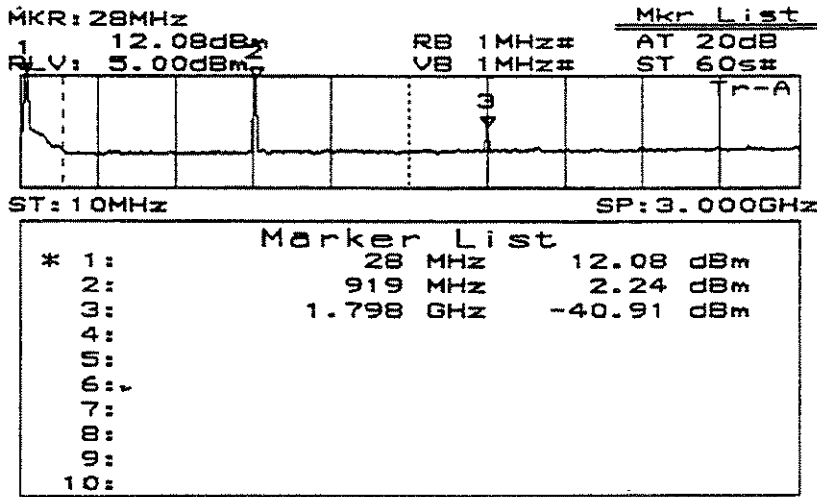

Example of Spurious Detection

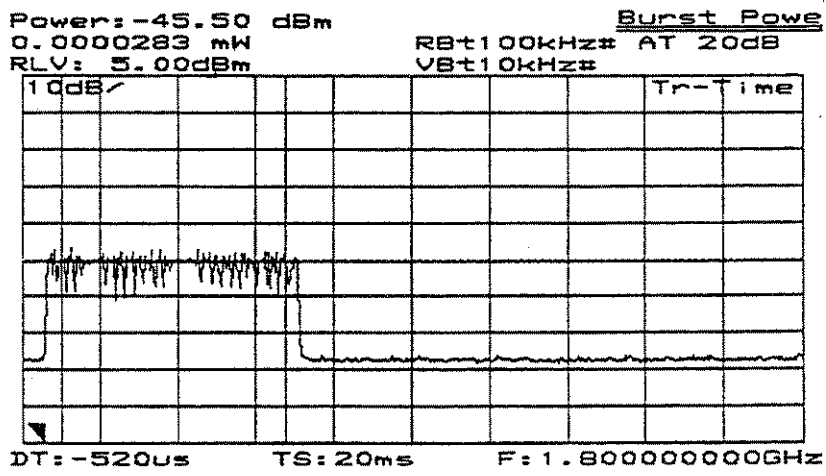

Example of Spurious Strength measurement

## Examples of Carrier-Off Leakage Power Measurement (Time Domain Spectrum Analysis)

Example 1 When external trigger used

- Set the detection mode to the Pos Peak mode.

(1) Measurement block diagram

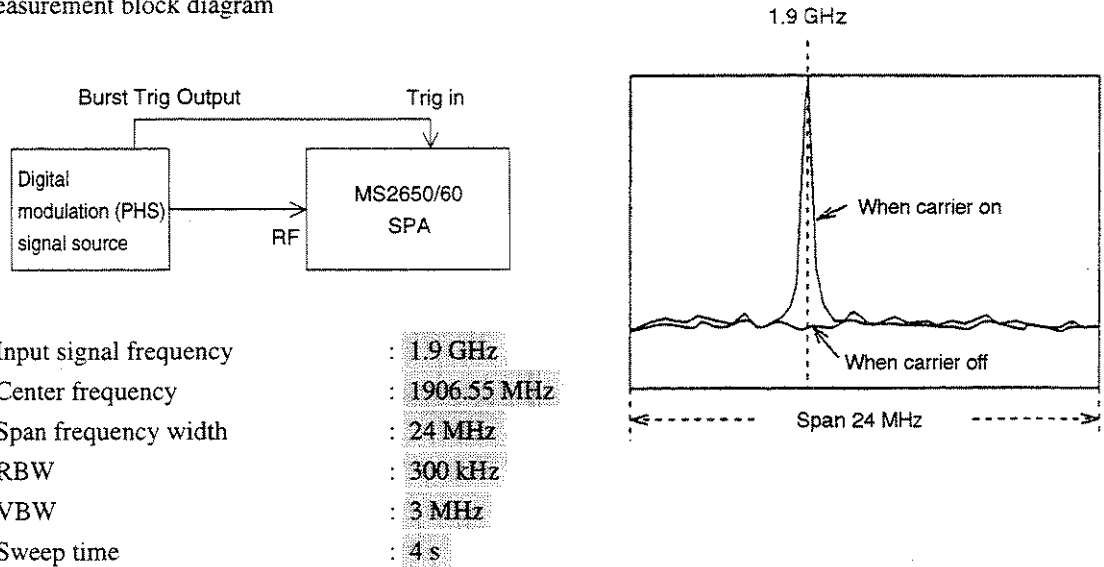

(2) Measurement procedure

Step	Procedure
1	[Preset], F1: <<Preset All>>
2	Time domain setting : [Time]
3	Reference level setting : [Amplitude], [2], [0], [dBm]
4	Center frequency setting : [Frequency], [1], [.] , [9], [GHz]
5	RBW setting : [RBW], [1], [MHz]
6	VBW setting : [VBW], [1], [MHz]
7	Time domain setting : [Time], F2: <<Time Sweep>>, [5], [msec]
8	Reference setting : After one sweep, press [→ RLV].
9	Trigger setting : Select Triggered with [Trig/Gate], F1: <<Trigger>> and select Rise with F2: <<Trigger Source>>, F3: <<External>>, F4: <<-10 to 10>>, and F5: <<Trig Slope>>, F4: <<Trig Level>>, [2], [V]

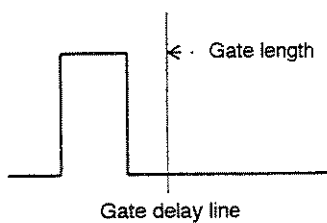
Step	Procedure
10	RBW setting : [RBW], [3], [0], [0], [kHz]
11	VBW setting : [VBW], [3], [MHz]
12	Gate setting : Press [Trig/Gate] until F1: <<Gate Sweep> is displayed. Select On with F1: <<Gate Sweep>>. F2: <<Gate Setup>>, F1: <<Gate Delay>>, and set the gate delay line to the carrier-off region with the rotary knob. F2: <<Gate Length>>, and set the gate length as shown at the right.
	
13	Span frequency setting : [Span], [2], [4], [MHz]
14	Center frequency setting : [Frequency], [1], [9], [0], [6], [.] , [5], [5], [MHz]
15	Sweep time setting : [Sweep Time], [4], [s], [Single]
	(A) Carrier-off leakage power value P(OFF)
16	Multi Mkr setting : [Shift], [Marker] (Multi Mkr), F2: <<Highest 10>>, F5: <<Marker List>> A carrier-off leakage power list (frequency and level of each) is displayed. At this time, if the message "Can not search" is displayed, press [Peak Search].
	★Example of measurement result: -82.57 dBm
	(B) Carrier-on leakage power value P(ON)
17	Turn off the gate : Press [Trig/Gate] until F1: <<Gate Sweep>> is displayed. Select Off with F1: <<Gate Sweep>, then press [Single].
18	Marker setting : [Peak Search] The power when the carrier is on is displayed.
	★Example of measurement result: -15.57 dBm.
	Carrier off/on power ratio: P(L)-P(O)



## Example 2 When Wide IF Video trigger used

- Set the detection mode to the Pos Peak mode.

## (1) Measurement block diagram

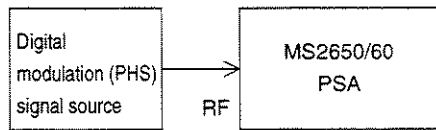

- Input signal frequency : 1.9 GHz
- Center frequency : 1906.55 MHz
- Span frequency width : 24 MHz
- RBW : 300 kHz
- VBW : 3 MHz
- Sweep time : 4 s

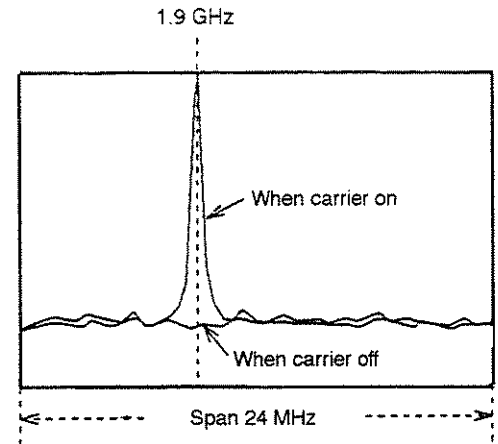

## (2) Measurement procedure

Step	Procedure
1	Select Independent with [Preset], F1: <<Preset All>>, [Shift], [1] (System), F1: <<Couple>>.
2	Reference level setting : [Amplitude], [2], [0], [dBm]
3	Center frequency setting : [Frequency], [1], [.] , [9], [GHz]
4	RBW setting : [RBW], [1], [MHz]
5	VBW setting : [VBW], [1], [MHz]
6	Time span setting : [Time], F2: <<Time Span>>, [5], [msec]
7	Reference level setting : After 1 sweep, press [→RLV].
8	Trigger setting : Select Triggered with [Trig/Gate] and F1: <<Triggered>> and set to the level at which the trigger is to be applied by changing F1: <<Trigger Level>> to High, Middle, or Low. (Use Low as much as possible.)
9	RBW setting : [RBW], [3], [0], [0], [kHz]
10	VBW setting : [VBW], [3], [MHz]

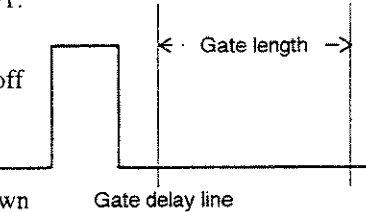
Step	Procedure
11	<p data-bbox="378 302 1325 369">Gate setting : Press [Trig/Gate] until F1: &lt;&lt;Gate Sweep&gt;&gt; is displayed. Select On with F1: &lt;&lt;Gate Sweep&gt;&gt;.</p> <p data-bbox="703 380 1040 531">Press F2: &lt;&lt;Gate Setup&gt;&gt;, F1: &lt;&lt;Gate Delay&gt;&gt; and set the gate delay line to the carrier-off region with the rotary knob.</p> <p data-bbox="703 541 1040 688">Press F2: &lt;&lt;Gate Length&gt;&gt; and set the gate length as shown in the figure at the right with the rotary knob.</p> 
12	Span frequency setting : [Span], [2], [4], [MHz]
13	Center frequency setting : [Frequency], [1], [9], [0], [6], [1], [5], [5], [MHz]
14	Sweep time setting : [Sweep Time], [4], [s]
	(A) Carrier-off leakage power value P(L)
15	<p data-bbox="378 940 1344 1096">Multimarker setting : [Shift], [Marker] (Multi Mkr), F2: &lt;&lt;Highest 10&gt;&gt;, F5: &lt;&lt;Marker List&gt;&gt; A carrier-off leakage power list (each frequency and level) is displayed. At this time, if the message "Can not search" is displayed, press [Peak Search].</p> <p data-bbox="378 1129 896 1159">★Example of measurement result: -82.57 dBm</p>
	(B) Carrier-on leakage power value P(ON)
16	<p data-bbox="378 1184 1334 1306">Turn off the gate : Press [Trig/Gate] until F1: &lt;&lt;Gate Sweep&gt;&gt; is displayed. Select Off with F1: &lt;&lt;Gate Sweep&gt;&gt;, then press [Single].</p>
17	Marker setting : [Peak Search] The power when the carrier is on is displayed.
	★Example of measurement result: -15.57 dBm
	Carrier off/on power ratio: P(L)-P(O)

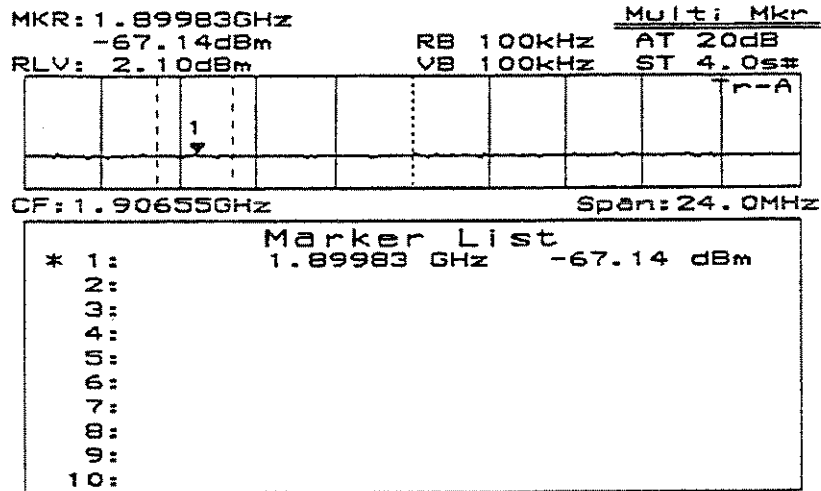

Example of Carrier-Off Leakage Power P(L) Measurement

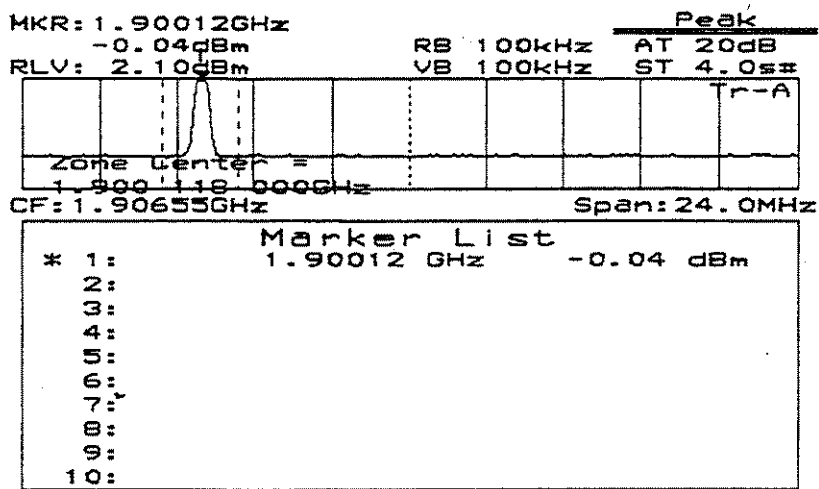

Example of Carrier-On Leakage Power P(O) Measurement

## Example of Measurement of Adjacent Channel Leakage Power

(1) Measurement block diagram

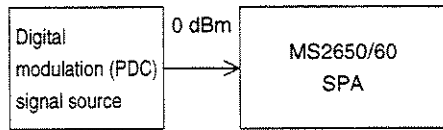

- Center frequency : 900 MHz
- Span frequency width : 250 kHz
- RBW : 1 kHz
- VBW : 3 kHz
- Sweep time : 10 s

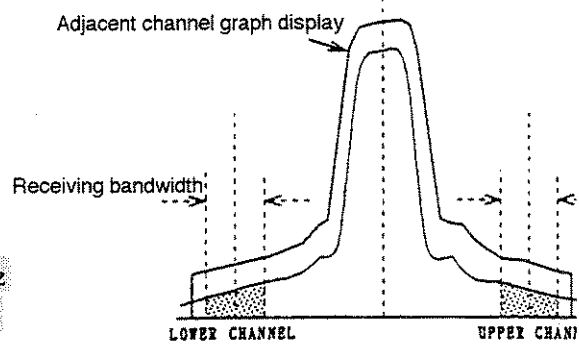

(2) Measurement procedure

Step	Procedure
1	[Preset], F1: <<Preset All>>
2	Span frequency setting : [Span], [2], [5], [0], [kHz]
3	Center frequency setting : [Frequency], [9], [0], [0], [MHz]
4	RBW setting : [RBW], [1], [kHz]
5	VBW setting : [VBW], [3], [kHz]
6	Reference level setting : [Amplitude], [0], [dB]
7	Sweep time setting : [Sweep Time], [1], [0], [s]
8	ATT setting : Press [ATTEN], then set to the minimum value with the rotary knob.
9	Single sweep : [Single]
10	Measurement preparation : Press [Measure] until F2: <<Adj Ch Pwr Measure>> is displayed, then press F2: <<Adj Pwr Measure>>.
11	Adjacent channel setting : F2: <<Ch Sepa-1>>, [5], [0], [kHz] F3: <<Ch Sepa-2>>, [1], [0], [0], [kHz] (*1)
12	Receiving bandwidth setting: F4: <<Ch BW>>, [2], [1], [kHz]

Step	Procedure
13	Method of calculation : Select Total Pwr or Ref Level or Inband with F5: <<Setup>>, F1 to F3 <<Method>>. (*2)
14	Graph display : On page 2 of <<set up>> when On is selected with F1: <<ACP Graph>>, graph display is performed.
15	Channel display method : When On is selected with F2: <<Ch Center Line>>, a line which indicates the adjacent frequency center frequency is displayed. When On is selected with F3: <<Ch BW Line>>, a line which indicates the adjacent channel bandwidth is displayed. When On is selected with F4:<<Inband BW Line>>, a line which indicates the Inband is displayed.
16	Measurement channel setting: [More], F1: <<Both Channel>>, F6: <<return>>
17	Measurement: F1 : <<Execute>> The measured value is displayed at the top left-hand corner of the screen.

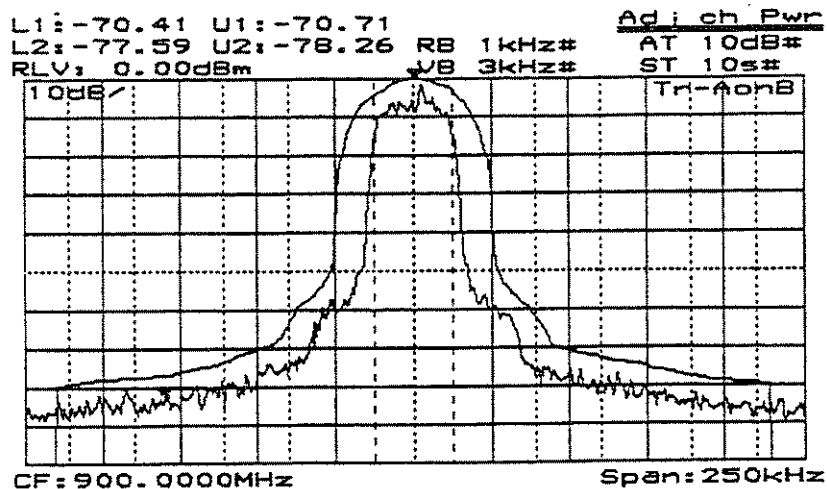

Example of Adjacent Channel Leakage Power Measurement

Note:

- \*1 Reference channel center-In total power method and Inband method, this is defined as the center of zone marker.  
In Reference level method, the display's center is defined as reference channel center.
- \*2 The reference value for each of the calculation method is defined as below.  
Total Power method: The total power of entire waveform displayed.  
Ref Level method: The reference level value of the display.  
Inband method: The total power in the "Inband" defined with marker zone center as reference channel center.

## Example of Memory Card Use

If the measurement screen is stored in a memory card, the same measurement can be performed later by recalling the stored measurement screen. This eliminates troublesome setting of the measurement parameters each time and prevents setting errors. It is designed especially to shorten the measurement time when the setting operation is complex.

Storage method (Assume that the DATA number is 20.)

- 1) Measurement screen single sweep: [Single]
- 2) Press [Shift], [Recall] (save), [More] until F1: <<Save to Mem Card>> is displayed, then press F1: <<Save to Mem Card>>, [2], [0], [Enter].

This completes saving of the screen parameters to Memory Card 20.

Recalling method (Assume that the DATA number is 20.)

- 1) Stored screen display : Press [More] until [Recall], F1: <<Recall from Mem Card>> is displayed, then press F1: <<Recall from Mem Card>>, [2], [0], [Enter].
- 2) Continuous sweep : [Continuous]

## Example of Time Template Creation (PHS Transmit Signal)

### 1) Burst wave screen setting (time domain)

Time span : 1 ms  
 Trigger : -200 us  
 RBW : 1 MHz  
 VBW : 1 MHz  
 RLV : +15 dBm

### 2) Template data overwrite method

- Template scale number setting (No. 1 here):  
 Press [Time], [Measure] until F1: <<Time Template>> is displayed, then press F1: <<Time Template>>, F5: <<Setup Temp Table>>, F1: <<Select Temp Table>>, F1: <<Temp-1>>, F6: <<return>>.
- Data write preparation: Select Relative with F2: <<Level>>.  
 F3: <<Make Up Temp Table>>, [More], F2: <<Select Line>>, F1: <<Limit1 Upper>>, F6: <<return>>, [More] (Here, Limit1 Upper is specified.)
- Data write: Sequentially write the coordinates (time, level) of the template to be created in ascending order of time value.  
 Write data by alternately repeating time setting and level setting.
  - \* Time setting (example: -200 us) : [+/-], [2], [0], [0], [us]
  - \* Level setting (example: -65 dB) : [+/-], [6], [5], [dB]
- Limit1 Lower write: Press [More], F2: <<Select Line>>, F2: <<Limit 1 Lower>>, F6: <<return>>, [More], then write the template coordinate data.

MKR: 300us  
 7.84dBm  
 RLV: 15.00dBm

RBt1MHz#  
 VBt1MHz#

20dB/

DT: -200us TS: 1.0ms F: 1.900

1	-200.000us	-65.00
2	-4.600us	-65.00

Edit  
 ←  
 →  
 Insert/  
**Replace**  
 Delete  
 Graph/  
**List**  
 return  
 | | |

TEMPLATE Creation Screen (Graph)

No.	Time	Level ( dB )
1	-200.000us	-65.00
2	-4.600us	-65.00
3	-4.600us	-1.00
4	594.320us	-1.00
5	594.320us	-65.00
6	1.000000ms	-65.00
7		
8		
9		
10		
11		
12		

1	-200.000us	-65.00
2	-4.600us	-65.00

Edit  
 ←  
 →  
 Insert/  
**Replace**  
 Delete  
 Graph/  
**List**  
 return  
 | | |

TEMPLATE Creation Screen (List)



## 3) Template coordinates (PHS: RCR STD-28)

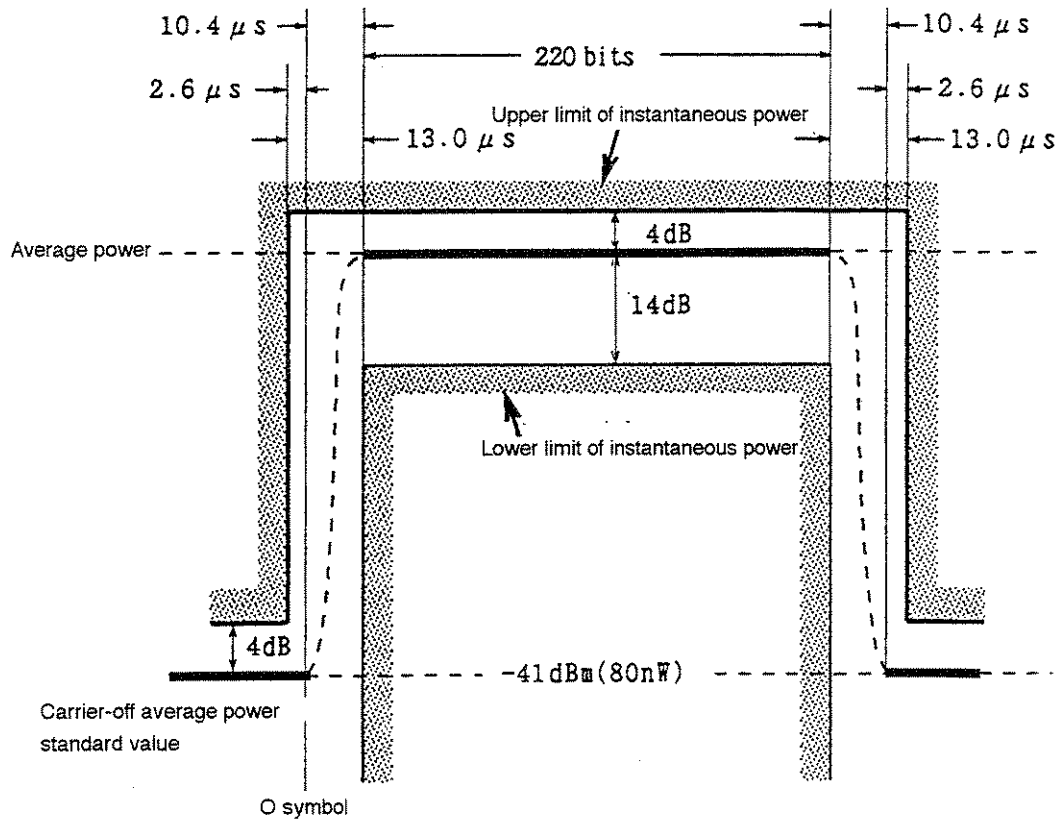

Coordinate reference line (Trigger position  $\rightarrow$  left end of screen:  $-200 \mu\text{s}$ )

When average power in burst of input signal is 19 dBm and SPA REF LEVEL is 24 dBm

• Limit I Upper coordinates

(1)	$-200 \mu\text{s}$ ,	$-65 \text{ dB}$
(2)	$-4.6 \mu\text{s}$ ,	$-65 \text{ dB}$
(3)	$-4.6 \mu\text{s}$ ,	$-1 \text{ dB}$
(4)	$594.32 \mu\text{s}$ ,	$-1 \text{ dB}$
(5)	$594.32 \mu\text{s}$ ,	$-65 \text{ dB}$
(6)	$1 \text{ ms}$ ,	$-65 \text{ dB}$

• Limit I Lower coordinates

(1)	$8.40 \mu\text{s}$ ,	$-100 \text{ dB}$
(2)	$8.40 \mu\text{s}$ ,	$-19 \text{ dB}$
(3)	$581.32 \mu\text{s}$ ,	$-19 \text{ dB}$
(4)	$581.32 \mu\text{s}$ ,	$-100 \text{ dB}$

4) Template coordinates (PDC-RCR STD-27B)

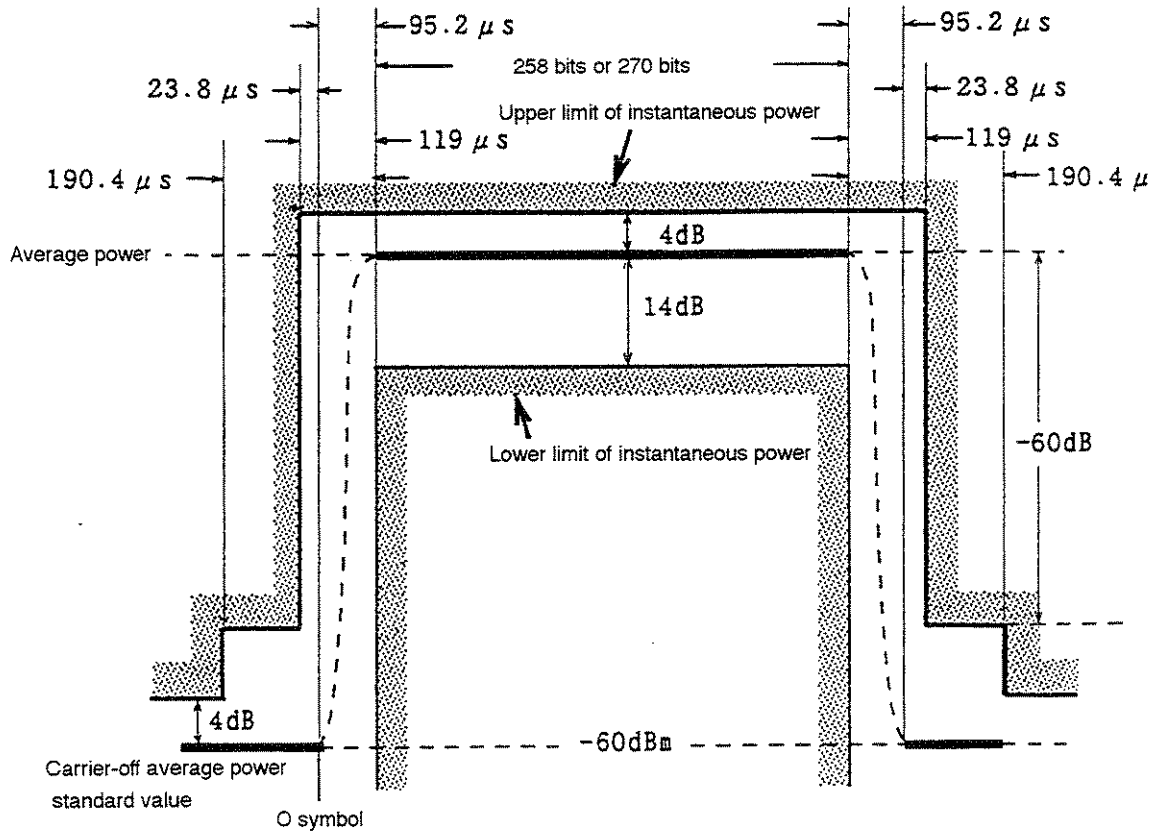

Coordinates standard line (Trigger position → screen left end: -1 ms)

When average power in burst of input signal is 10 dBm and SPA REF LEVEL is 15 dBm

• Limit1 Upper coordinates

(1)	-1.7 ms,	-71 dB
(2)	-114.21 μ s,	-71 dB
(3)	-114.21 μ s,	-65 dB
(4)	42.81 μ s,	-65 dB
(5)	42.81 μ s,	-1 dB
(6)	6.6238 ms,	-1 dB
(7)	6.6238 ms,	-65 dB
(8)	6.6952 ms,	-65 dB
(9)	6.6952 ms,	-71 dB
(10)	8.3 ms,	-71 dB

• Limit1 Lower coordinates

(1)	76.19 μ s,	-100 dB
(2)	76.19 μ s,	-19 dB
(3)	6.5048 ms,	-19 dB
(4)	6.5048 ms,	-100 dB

## 5) Template coordinates (GSM, DCS1800)

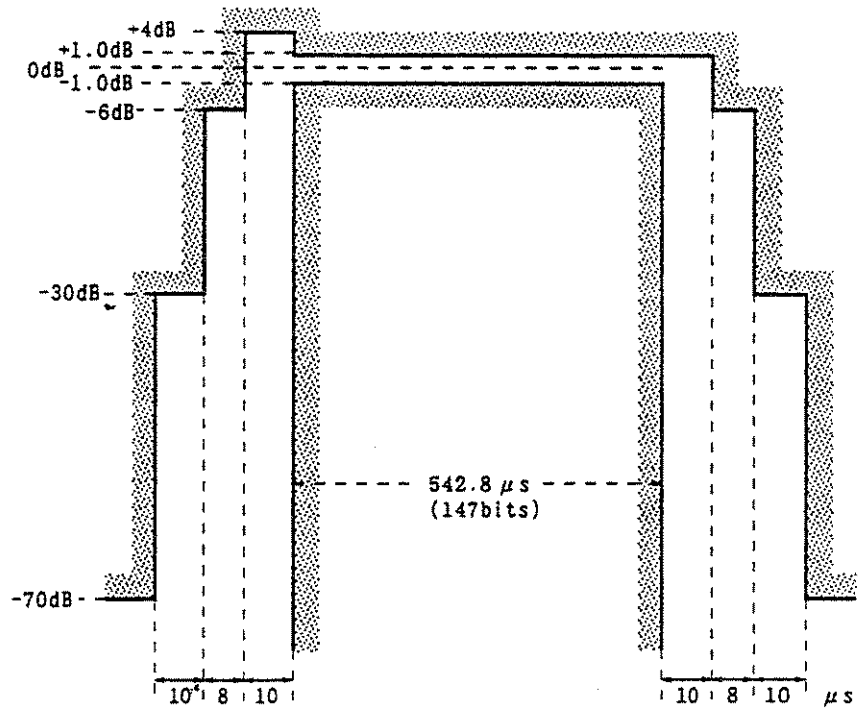

Coordinates standard line (Trigger position → left end of screen:  $-75.0 \mu s$ )

## • Limit 1 Upper coordinates

(1)	$-75.0 \mu s$ ,	$-75 \text{ dB}$
(2)	$-25.0 \mu s$ ,	$-75 \text{ dB}$
(3)	$-25.0 \mu s$ ,	$-35 \text{ dB}$
(4)	$-15.0 \mu s$ ,	$-35 \text{ dB}$
(5)	$-15.0 \mu s$ ,	$-11 \text{ dB}$
(6)	$-7.0 \mu s$ ,	$-11 \text{ dB}$
(7)	$-7.0 \mu s$ ,	$-1 \text{ dB}$
(8)	$3.0 \mu s$ ,	$-1 \text{ dB}$
(9)	$3.0 \mu s$ ,	$-4 \text{ dB}$
(10)	$555.8 \mu s$ ,	$-4 \text{ dB}$
(11)	$555.8 \mu s$ ,	$-11 \text{ dB}$
(12)	$563.8 \mu s$ ,	$-11 \text{ dB}$
(13)	$563.8 \mu s$ ,	$-35 \text{ dB}$
(14)	$573.8 \mu s$ ,	$-35 \text{ dB}$
(15)	$573.8 \mu s$ ,	$-75 \text{ dB}$
(16)	$625.0 \mu s$ ,	$-75 \text{ dB}$

## • Limit 1 Lower coordinates

(1)	$3.0 \mu s$ ,	$-100 \text{ dB}$
(2)	$3.0 \mu s$ ,	$-6 \text{ dB}$
(3)	$545.8 \mu s$ ,	$-6 \text{ dB}$
(4)	$545.8 \mu s$ ,	$-100 \text{ dB}$

## MASK Creation in Frequency Domain Mode

### 1) Mask data write method

- Template scale number setting (Here it is 1.):  
 Press [A, B] and F1: <<Trace A>> and press [Measure] until F3: <<Mask>> is displayed, then press F3: <<Mask>>, F5: <<Setup Mask Table>>, F1: <<Select Mask Table>>, F1: <<Mask-1>>, F6: <<return>>.
- Data write preparation: Select Relative with F2: <<Level>>.  
 F3: <<Make Up Mask Table>>, [More], F2: <<Select Line>>, F1: <<Limit1 Upper>>, F6: <<return>>, [More] (Here, Limit1 Upper is specified.)
- Data write: Write the coordinates (frequency, level) of the template to be created in ascending order of time value.  
 Write the data by alternately repeating time setting and level setting.
  - \* Frequency setting (example: 800 MHz): [8], [0], [0], [MHz]
  - \* Level setting (example: -60 dB): [+/-], [6], [0], [dB]
- Limit1 Lower write: Press [More], F2: <<Select Line>>, F2: <<Limit1 Lower>>, F6: <<return>>, [More], then write the mask data coordinates data.

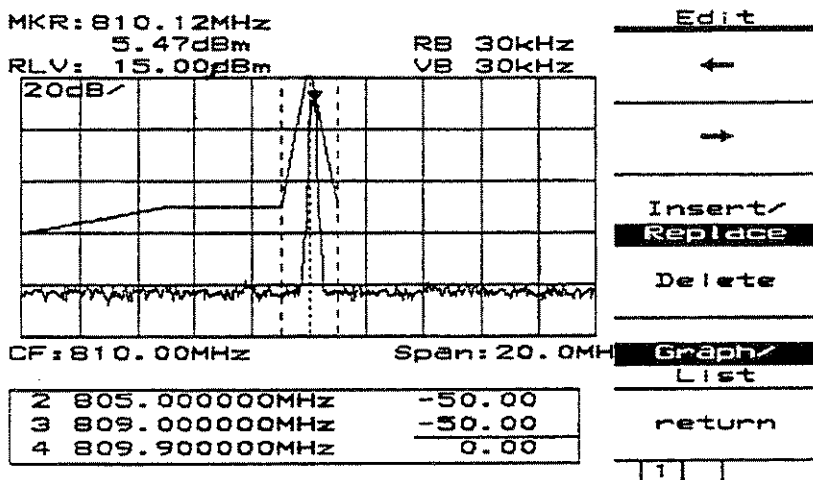

MASK Creation Screen (Graph)

No.	Frequency	Level ( dB )
1	800.000000MHz	-60.00
2	805.000000MHz	-50.00
3	809.000000MHz	-50.00
4	809.900000MHz	0.00
5	810.100000MHz	0.00
6	811.000000MHz	-50.00
7		
8		
9		
10		
11		
12		

2	805.000000MHz	-50.00
3	809.000000MHz	-50.00
4	809.900000MHz	0.00

Edit  
 ←  
 →  
 Insert/  
**Replace**  
 Delete  
 Graph/  
**List**  
 return  
 | | |

MASK Creation Screen (List)

# SECTION 14

## TRACKING GENERATOR

This section describes the Tracking Generator (Option 20/23)'s function-key menus, Normalize/Instant-Normalize functions, measurement example of band-pass-filter transmission-characteristics/reflection-characteristics, and notes on active-device (including amplifier) measurement.

### TABLE OF CONTENTS

Tracking Generator Menus .....	14-3
Normalize/Instant-Normalize Functions .....	14-4
Transmission Characteristics Measurement .....	14-6
Characteristics Outline Measurement .....	14-6
3dB-Bandwidth and Insertion-Loss Accurate Measurement .....	14-9
Reflection Characteristics Measurement .....	14-13
Notes on Active Device Measurement .....	14-17

### CAUTION

---

Measurements using tracking generator at very low frequencies are beating to be affected by the local feed through.

To eliminate the effect of the local feed through on measurements at low frequencies, it is necessary to chose appropriate RBW.

The approximate value of appropriate RBW is less than or equal to 1/10 th of the lowest frequency limit under measurement.

■ TG Output connector

standard (50  $\Omega$ ) : N-J

with Opt.23 (75  $\Omega$ ) : NC-J

Connect the correct type connector to the TG output. If connect the difference type one, output connector may be damaged.

■ Bath the Spectrum Analyzer and the Device Under Test must be earthed.

If the D.U.T or the Spectrum Analyzer is not earthed, tracking generator unit may be damaged.

---

# SECTION 14 TRACKING GENERATOR

## Tracking Generator Menus

The Tracking Generator(TG, Option 20/23) can be installed to the spectrum analyzer to measure the transmission characteristics and reflection characteristics of the passive devices(filters etc.) and active devices(amplifier etc.).

To turn the output On/Off, set the output level, and compensate the insertion loss of the cables/bridges etc.(normalizing function), perform the following key operations.

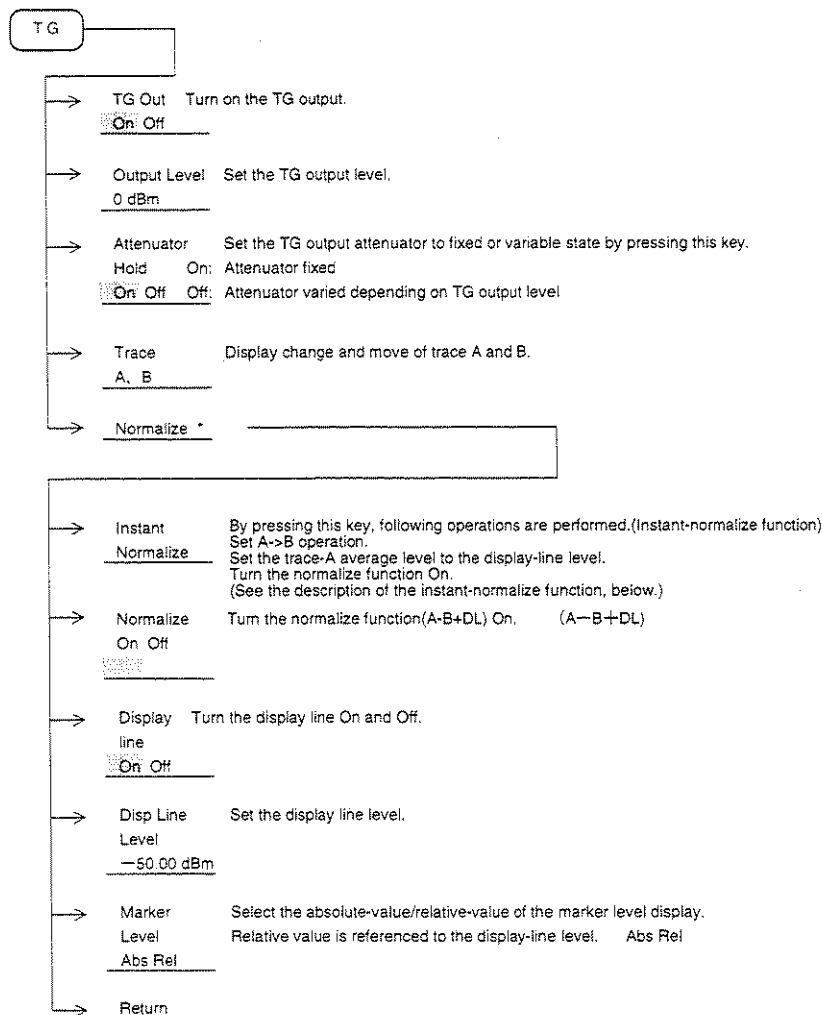

# Normalize/Instant-Normalize Function

For accurate measurement of the transmission characteristics and reflection characteristics by using TG, the insertion-loss frequency characteristics of the cables/bridges etc. must be compensated. The normalize function is used for this purpose.

The following figure shows the frequency characteristics which is not compensated for the coaxial cable connected from the TG Output to RF Input. The figure shows approx. one dB frequency-characteristics ripple.

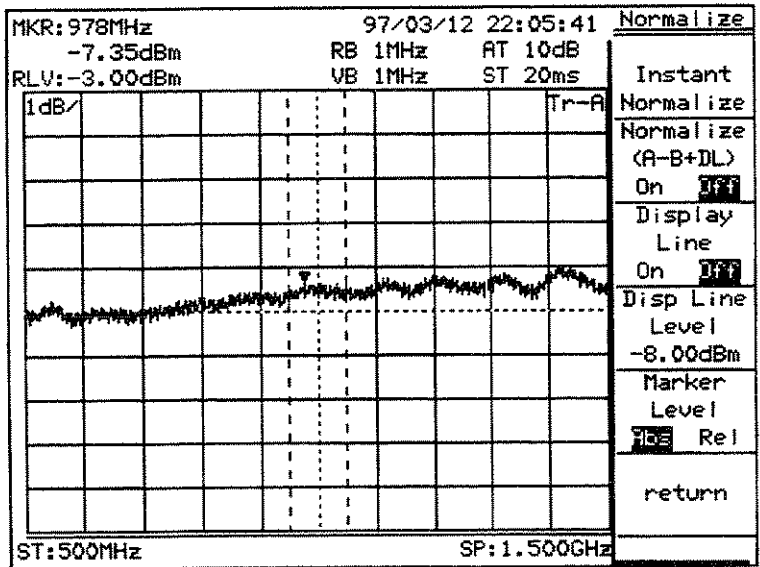

The normalize function compensates this frequency-characteristics ripple.

The following figure shows the frequency characteristics which is compensated by the instant-normalize function.

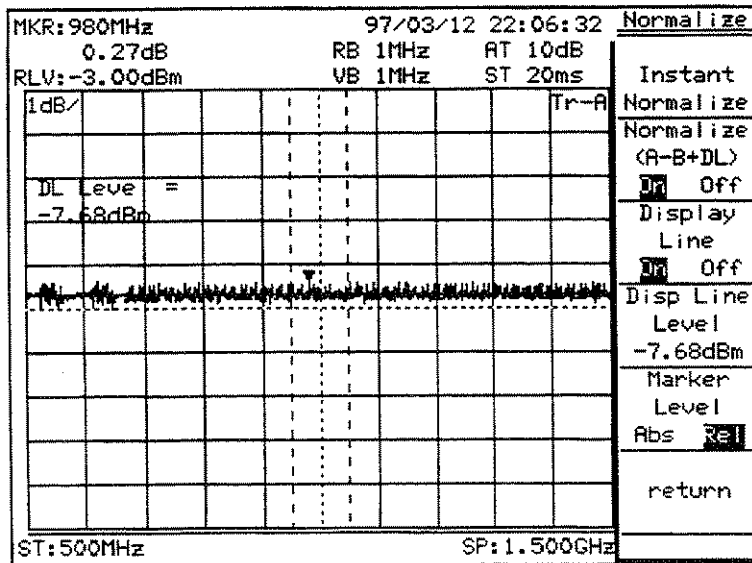



By the instant normalize function, the compensated waveform is displayed at the averaged level of the previous uncompensated waveform. The marker level is displayed with the relative value referenced to the display-line level.

When using the normalize function, the waveform is displayed with reference to the display line. So, by changing the display -line level, the compensated waveform can be displayed at any position.

The following figure shows the waveform moved by one scale division below the top line, by changing the display-line level.

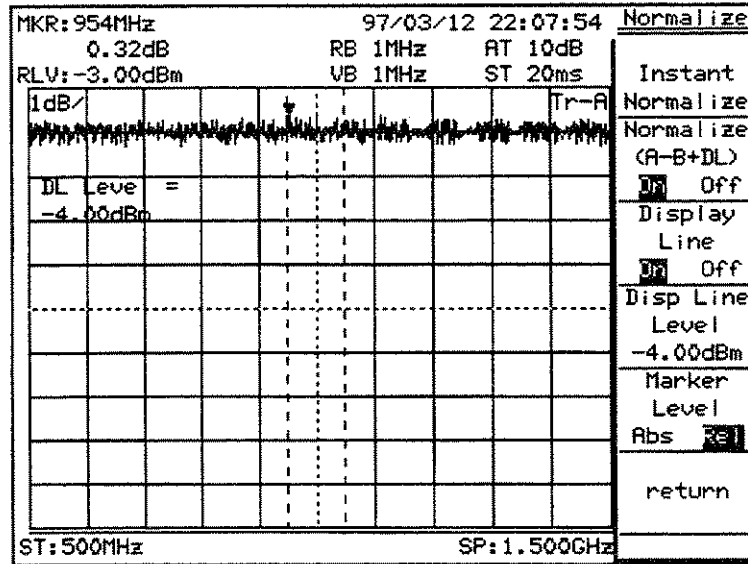

Hereafter, transmission-characteristics/reflection-characteristics measurements of a band-pass filter(BPF) are described below for examples of the TG application.

## Transmission Characteristics Measurement

Typical transmission characteristics measurement of a BPF is described below.

BPF characteristics:

- Center frequency: 500 MHz
- 3dB bandwidth: 27 MHz
- Insertion loss: -0.4 dB
- Input/Output connector: N jack (50  $\Omega$ ) or NC jack (75  $\Omega$ )

## Characteristics Outline Measurement

(1) Setup

Connect the TG Output to BPF input, and BPF output to RF Input with a coaxial cable, respectively.

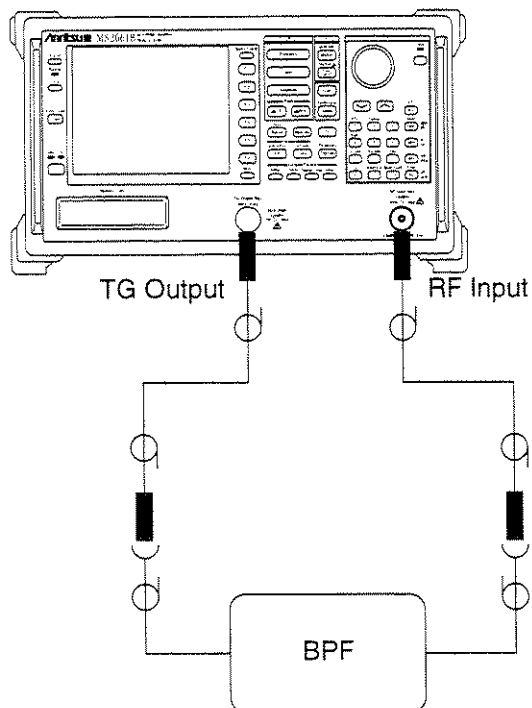

## (2) Setting parameters and measuring characteristics outline

- Setting parameters
  - Initializing the spectrum analyzer  
[Preset]
  - Setting center frequency to 500 MHz  
[Frequency], [5], [0], [0], [MHz]
  - Setting span to 100 MHz  
[Span], [1], [0], [0], [MHz]
  - Setting reference level to 0 dBm  
[Amplitude], [0], [dBm]
  - Setting TG to On  
[TG], F1: <<TG On Off>>

The following figure is obtained as the measurement results.

When accurate results not required, each frequency and level can be read using marker. In this case, the marker unit is dBm and TG output level is 0 dBm, then the marker level indicates the insertion loss, directly.

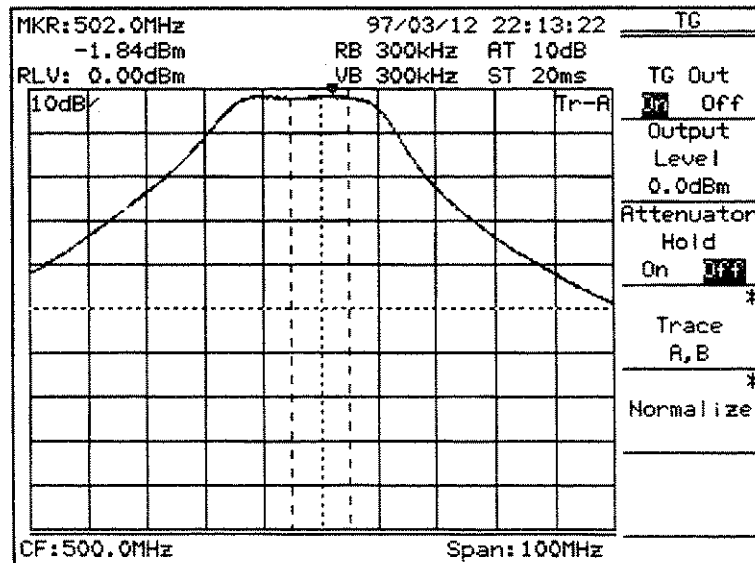

- When the TG output level is set to other than 0 dBm, the insertion loss can be read in dB unit by setting the marker level display to the relative value from the reference level, as the following procedures.
  - Setting the display-line to On. Setting the display-line level to the same as the TG output level. Setting the marker level display mode to the relative value  
Displaying the 2nd page of the TG menu: [TG], F5: <<Normalize>>  
F3: <<Display Line On Off>>  
F4: <<Display Line Level>>, (Setting the display-line level to the same as the TG output level)  
F5: <<Marker Level Abs Rel>>

(3) Measuring center frequency and 3dB bandwidth

Using the measurement function of the occupied bandwidth, measures the center frequency and 3dB bandwidth of the BPF.

- Setting  $x$ dB method and 3dB Down of the Occ BW measurement  
 Displaying the 2nd page of the Measure menu : [Measure], [More], F1:<<Occ BW>>, F5:<<Setup>>, F1:<<Method N% of Pwr  $x$ dB Down>>, F3:<< $x$ dB Value>>, [3], [dBm]
- Executing the Occ BW measurement  
 Displaying the 2nd page of the Measure menu : [Measure], [More], F1:<<Occ BW>>, F1:<<Execute>>

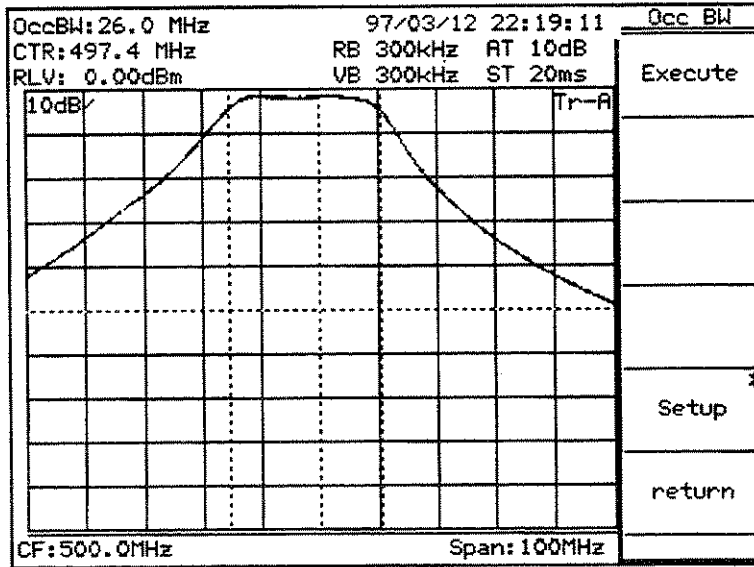

## 3dB-Bandwidth and Insertion-Loss Accurate Measurement

When accurate measurement required, the measurement level accuracy of the spectrum analyzer and insertion loss of the connecting cables must be considered. In this case, use the normalize function to calibrate these error factors.

Accurate 3dB-bandwidth/insertion-loss measurement procedure by using the normalize function, is shown below.

- (1) Measuring and calibrating (normalizing) the compensation factor of measurement system  
Remove the BPF, and connect only the coaxial cables.

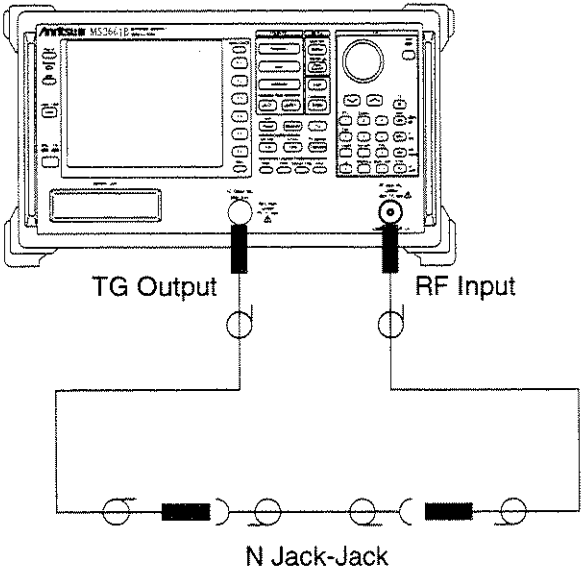

Measuring the compensation factor of the measurement system to calibrate the frequency characteristics, as shown below.

- Initializing the spectrum analyzer  
[Preset]
- Setting center frequency to 500 MHz  
[Frequency], [5], [0], [0], [MHz]
- Setting span to 100 MHz  
[Span], [1], [0], [0], [MHz]
- Setting reference level to 0 dBm  
[Amplitude], [0], [dBm]
- Setting TG to On  
[TG], F1:<<TG On Off>>
- Executing the instant normalize function  
[More], Displaying the 2nd page of the TG menu : F1:<<Instant Normalize>>

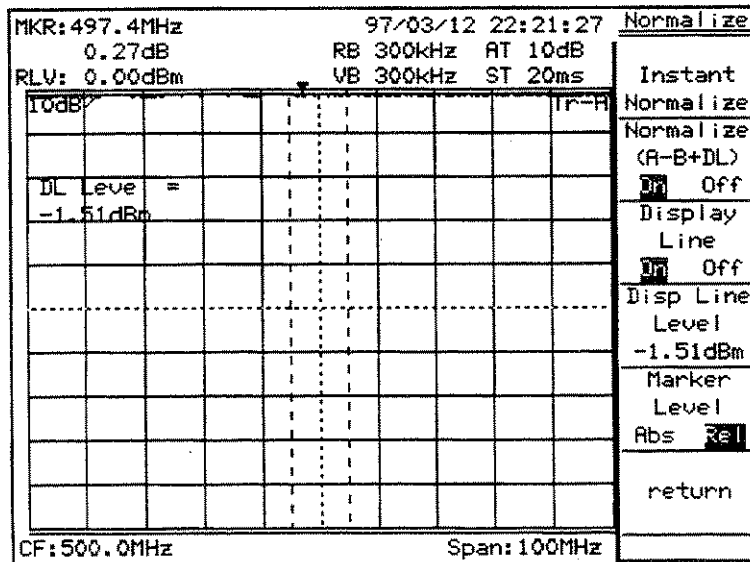

Note: Before executing the instant normalize function, turn the Normalize(A-B+DL) to Off, as shown below.

Displaying the 2nd page of the TG menu: [TG], [More], Turning the normalize(A-B+DL) function to Off : F2:<<Normalize(A-B+DL) On Off>>

The instant normalize function normalizes the current displaying Trace-A waveform.

(2) Setup

Connect the TG Output to BPF input, and BPF output to RF Input with a coaxial cable, respectively.

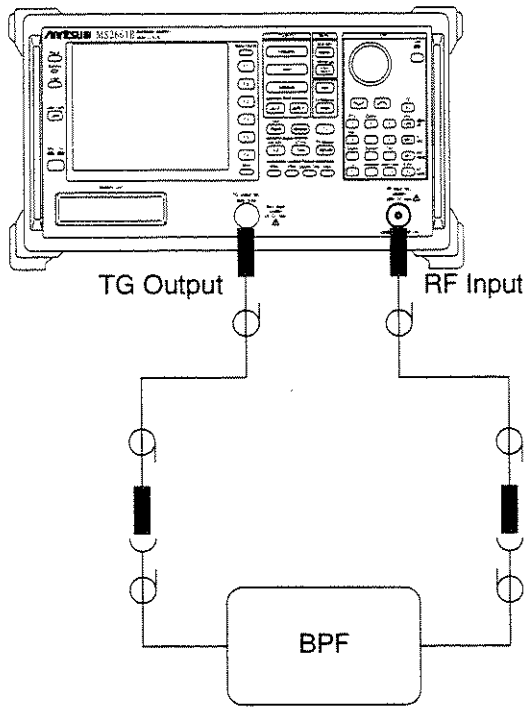

(3) Measuring characteristics

The following figure is obtained as the measurement results.

The marker level is displayed in the relative mode by setting the display-line level(normalized flat level) to the reference value. So, the marker level indicates the insertion loss, directly.

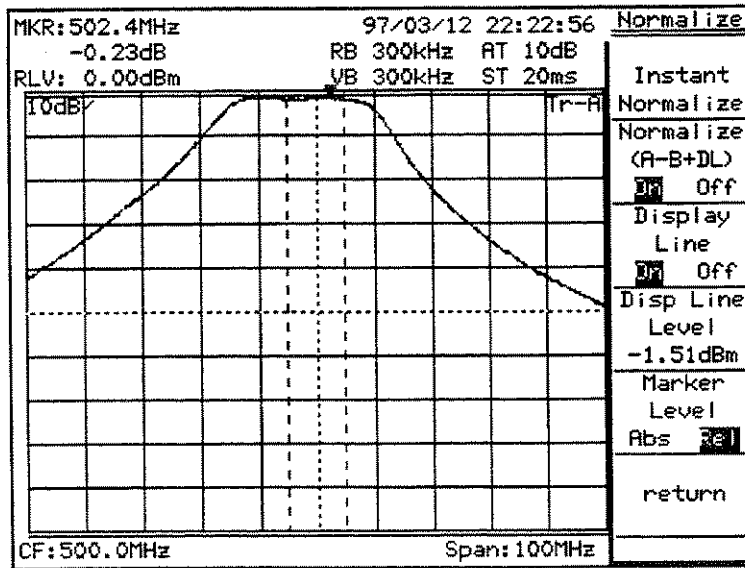

(4) Measuring center frequency and 3dB bandwidth

Using the measurement function of the occupied bandwidth, measures the center frequency and 3dB bandwidth of the BPF.

- Setting  $x$ dB method and 3dB Down of the Occ BW measurement  
 Displaying the 2nd page of the Measure menu : [Measure], [More], F1:<<Occ BW>>, F5:<<Setup>>, F1:<<Method N% of Pwr  $x$ dB DOWN>>, F3:<< $x$ dB Value>>, [3], [dBm]
- Executing the Occ BW measurement

Displaying the 2nd page of the Measure menu : [Measure], [More], F1:<<Occ BW>>, F1:<<Execute>>

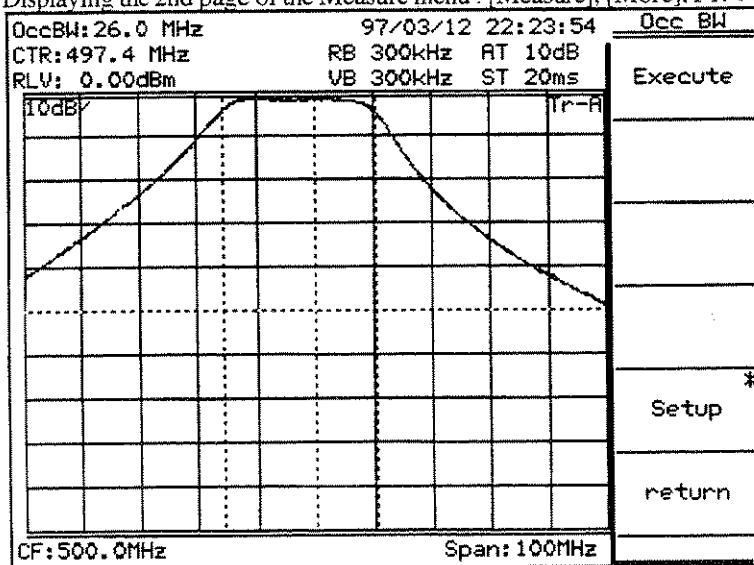

Note: Use the well impedance-matched coaxial cables between the spectrum analyzer and the device under test(BPF).

Especially over 2 GHz frequency, the cable selection becomes important for the accurate measurement.



## Reflection Characteristics Measurement

Reflection characteristics can be measured with a TG and a reflection bridge.

In this paragraph, reflection characteristics measurement of a BPF is described using the reflection bridge of the Wiltron 60NF50-1 or 62NF75.

BPF characteristics:

- Center frequency: 500.9 MHz
- 3dB bandwidth: 26.6 MHz
- Input/Output connector: N plug (50  $\Omega$ ) or NC plug (75  $\Omega$ )

In the reflection characteristics measurement, since the insertion loss of the reflection bridge is large, use the normalize function.

(1) Measuring and calibrating (normalizing) the compensation factor of measurement system

As shown below, connect the TG Output to the Input port of the 60NF50-1 or 62N75, and the RF Input to the Output port of the 60NF50-1 or 62N75, with a coaxial cable, respectively.

Set the Test port of the 60NF50-1 or 62N75 to open or short. Over 2 GHz, short is recommended to reduce the capacitive effect.

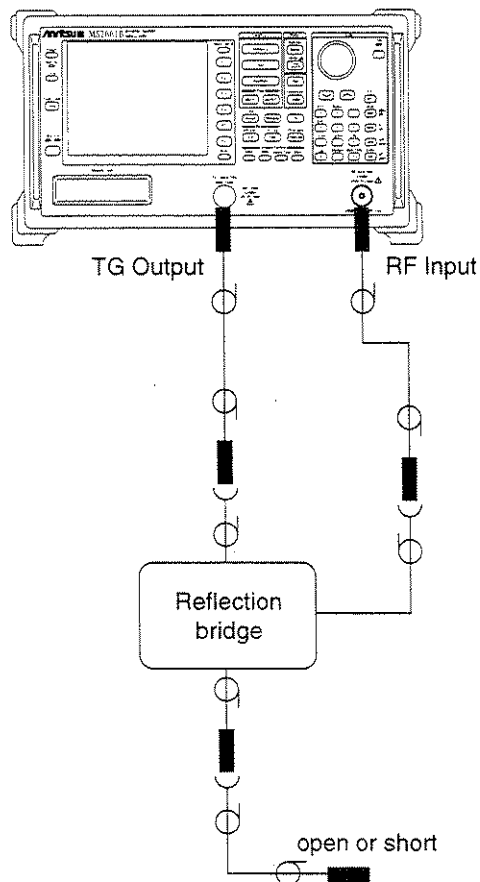

Measuring the compensation factor of the measurement system to calibrate the frequency characteristics, as shown below.

- Initializing the spectrum analyzer  
[Preset]
- Setting center frequency to 500.9 MHz  
[Frequency], [5], [0], [0], [.] , [9], [MHz]
- Setting span to 100 MHz  
[Span], [1], [0], [0], [MHz]
- Setting reference level to 0 dBm  
[Amplitude], [0], [dBm]
- Setting TG to On  
[TG], F1:<<TG On Off>>
- Executing the instant normalize function

Displaying the 2nd page of the TG menu: [More], F1:<<Instant Normalize>>

Note: Before executing the instant normalize function, turn the Normalize(A-B+DL) to Off, as shown below.

Displaying the 2nd page of the TG menu : [TG], [More], Turning the normalize(A-B+DL) function to Off: F2:<<Normalize(A-B+DL) On Off>>

The instant normalize function normalizes the current displaying Trace-A waveform.

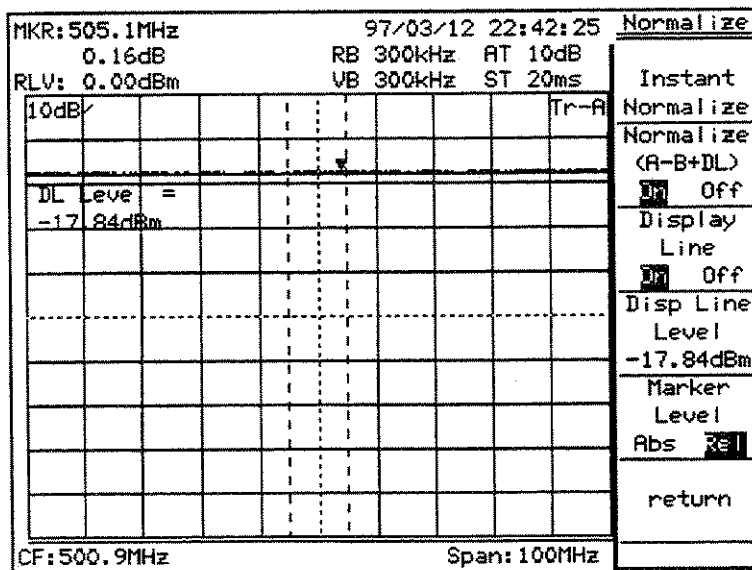

## (2) Setup

Connect the BPF to the Test port of the 60NF50-1 or 62N75.

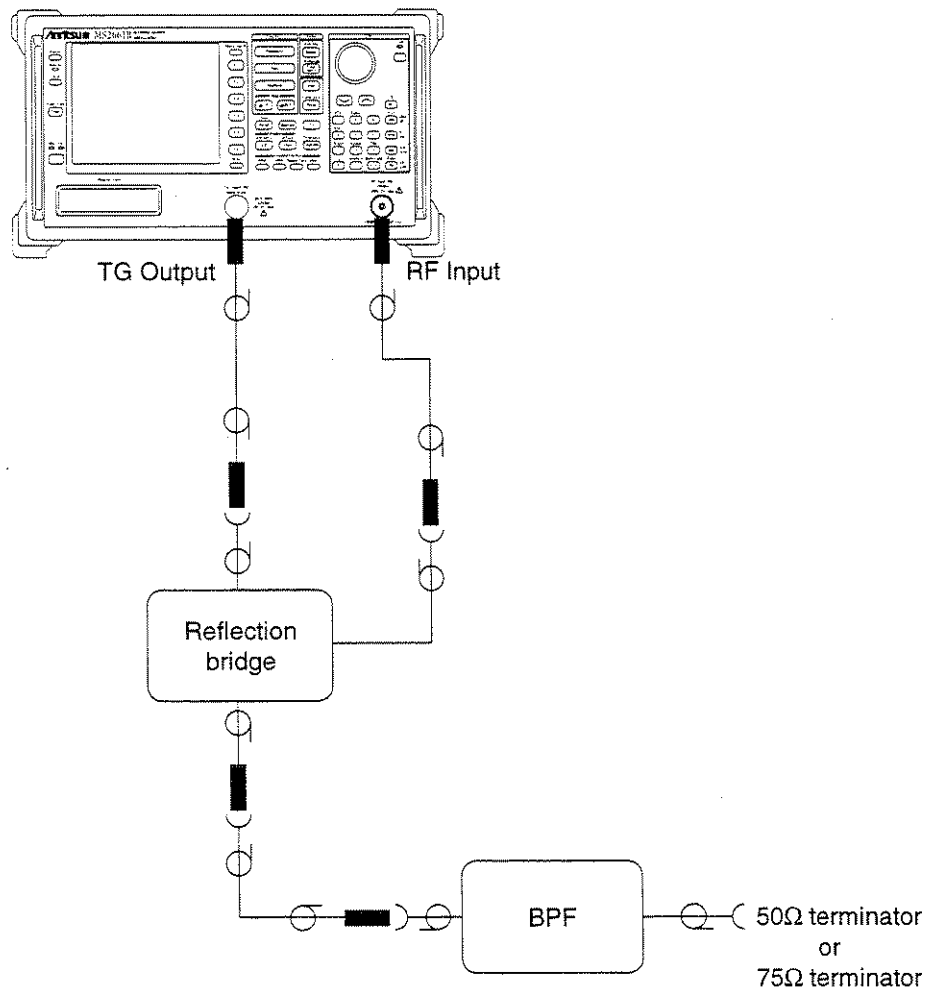

(3) Measuring characteristics

The following figure is obtained as the measurement results.

The marker level is displayed in the relative mode by setting the display-line level(normalized flat level) to the reference value. So, the marker level indicates the refraction loss, directly.

Take the following procedure.

- Turning the marker function to On(Normal mode)  
[Marker]
- Sets the marker zone width to Spot  
[Marker], F5:<<Marker Width>>, F1:<<Spot>>, F6:<<Return>>
- Moving the marker to the desired point to be measured by rotary knob

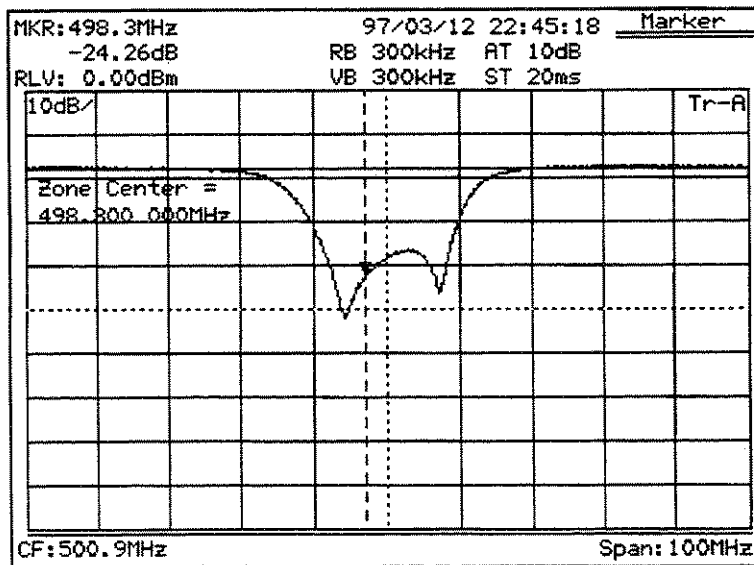

## Notes on Active Device Measurement

When measuring any active device(including an amplifier etc.), notes the following cautions.

### CAUTION

- 
- Maximum DC voltage ratings: RF Input  $\pm 50$  Vdc (standard), or  $\pm 100$  Vdc (with Option 22), TG Output 0 Vdc
  - Maximum AC power ratings: RF Input +30 dBm,  $\pm 10$  dBm, When Option 08 Pre-amplifier is On. TG Output +20 dBm, +25 dBm for Option 22
  - NEVER input a  $>+30$  dBm (+10 dBm for Option 08) and  $>\pm 50$  Vdc power to RF Input.
  - NEVER input a  $>+20$  dBm and  $>0$  Vdc reverse power (reflected power from DUT/power-splitter/directional-coupler) to TG Output.
  - Excessive power may damage the internal circuits.
- 

When measuring the transmission characteristics of any active device including an amplifier, note to decrease the TG output level by the amount of the amplifier gain. The procedures and notes are the same as the BPF, described in the previous paragraphs.

## SECTION 15

### EMC, Measurement of Field Strength

This chapter gives the explanation and cautions on the operation procedure of field strength measurement using MS2650/60B series spectrum analyzer, and EMC measurement by combining the analyzer with Option 12 or 13.

#### TABLE OF CONTENTS

Menu of EMC .....	15-3
Field Strength Measurement .....	15-4
Direct Measurement of Field Strength Using a Designated Antenna .....	15-4
Method to Seek Field Strength by Calculation .....	15-6
User Antenna Factor Setting, Save/Load to /from a Memory Card .....	15-7
User Antenna Factor Setting .....	15-7
Save/Load of User Antenna Factor To/From a Memory Card .....	15-12
Caution: When Performing Field Strength Automatic Measurement .....	15-13
EMC Measurement .....	15-15
Measurement of study .....	15-15
Basic Idea of the Measurement .....	15-16
Radioactive Jammer Measurement .....	15-16
Conductive Jammer Measurement .....	15-22
Items to be Noted in Measurement .....	15-25

# Chapter 15

## EMC, Measurement of Field Strength

### Chapter 15 EMC, Measurement of Field Strength

This chapter gives the explanation and cautions on the operation procedure of field strength measurement using MS2650/60B/C series spectrum analyzer, and EMC measurement by combining the analyzer with Option 12 or 13.

## Menu of EMC

This system is equipped with field strength measuring functions such as an antenna factor correction function or the like. Also, by mounting Option 12 or 13 and QP detector, EMC (conduction jammer, radiation jammer) measurement utilizing a QP/Average detector can be performed.

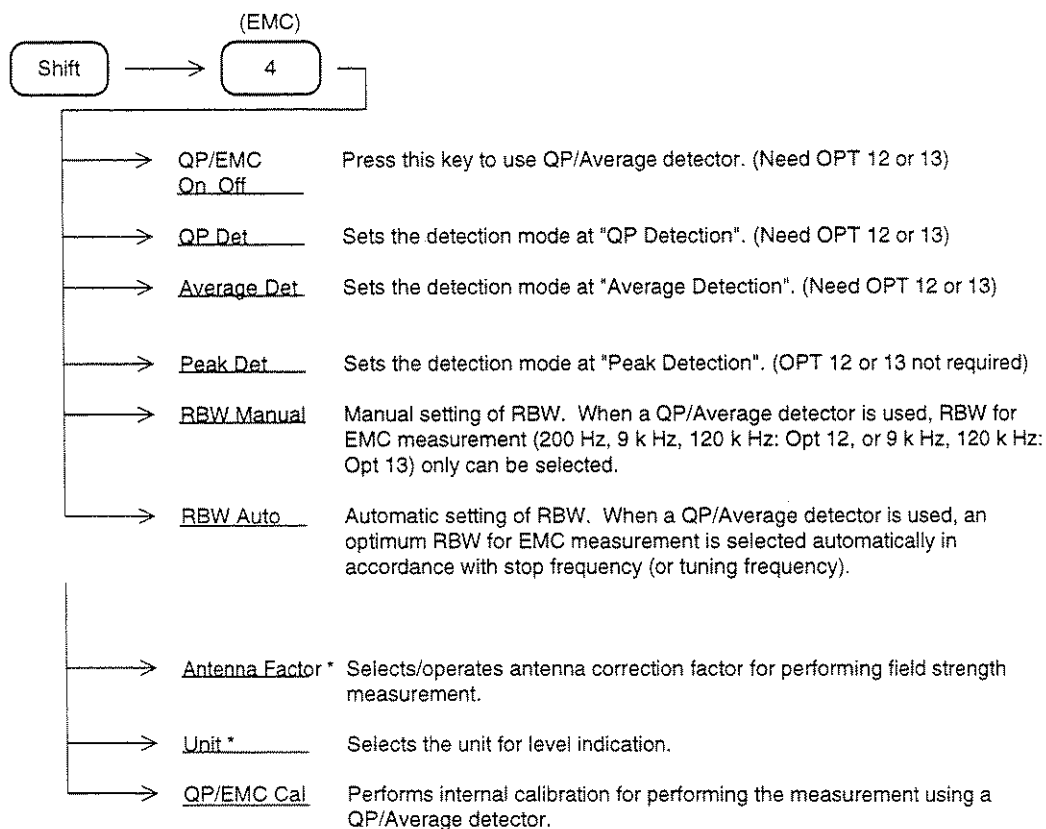

## Field Strength Measurement

In field strength measurement, incoming wave is received and measured by connecting a measuring antenna and RF Input connector of a spectrum analyzer with a coaxial cable as in the illustration below.

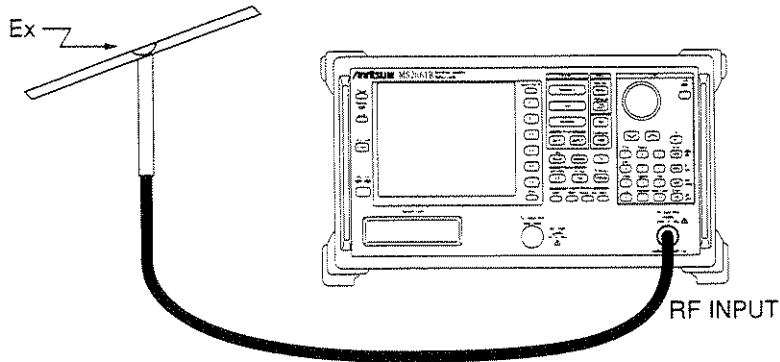

## Direct Measurement of Field Strength Using a Designated Antenna

The system has a built-in antenna factor correction process for the purpose of measurements using antenna. By selecting an antenna to be used from the menu, field strength can be directly indicated.

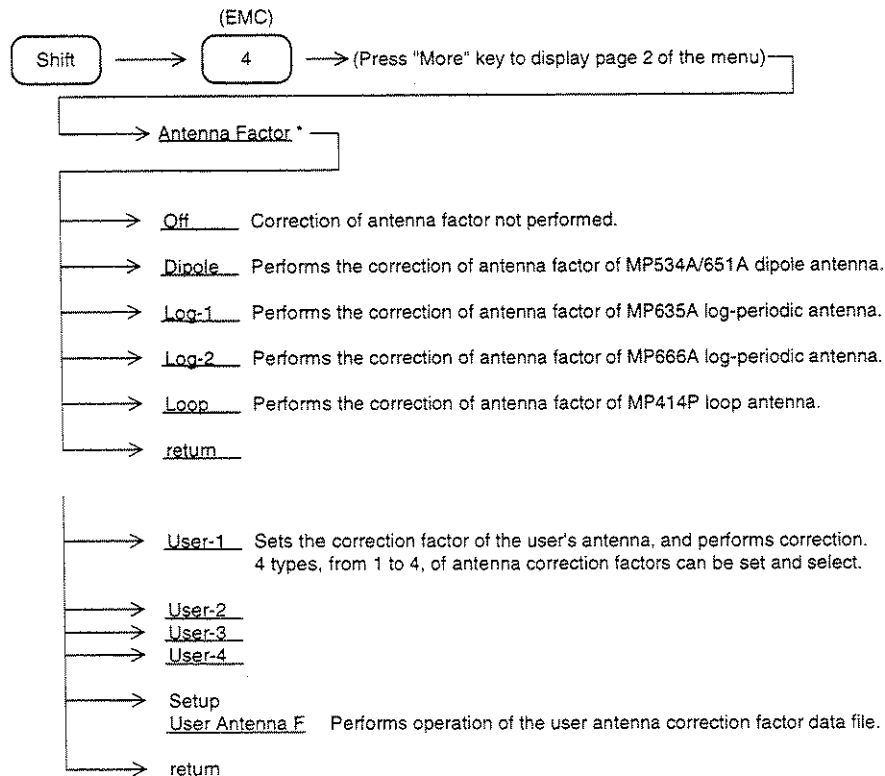



When an antenna to be used is selected, the indication unit of the levels is set to "dBμV/m" automatically. Correction factors of some antennas are defined by open terminal. In that case, set the unit at "dBμV(emf)" (open terminal).

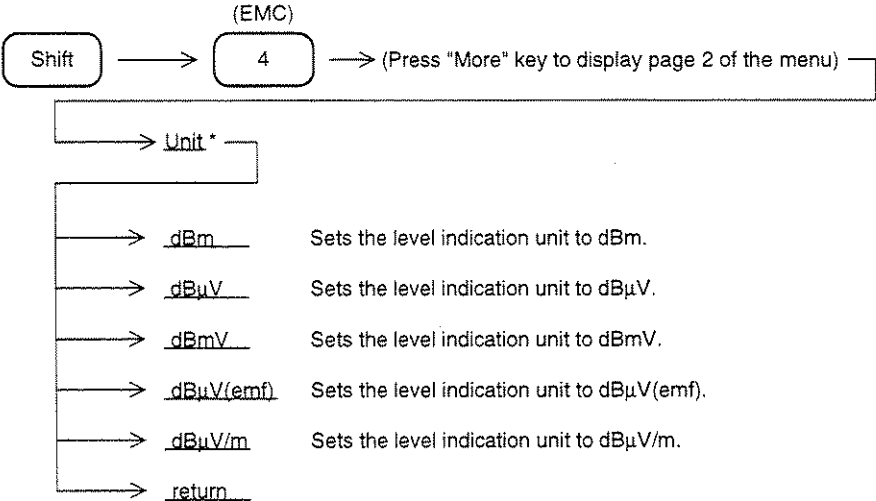

## Method to Seek Field Strength by Calculation

Generally, field strength is given by ( $E_x = P_x + K_0$ ).

$P_x$ : measured value (dB $\mu$ V)

$K_0$ : antenna calibration factor (dB) ..... The factor for converting the measured voltage {dB $\mu$ V (final value)} into field strength (dB $\mu$ V/m)

- a. Set the level indication unit to dB $\mu$ V, and measure the received signal by dB $\mu$ V.
- b. Refer the chart attached to the antenna for the value  $K_0$ , and calculate the appropriate field strength.

### Note

*In some antennas, the antenna calibration factor is defined by the following;*

$$E_x = P_x - K_0$$

*$P_x$ : measured value (dB $\mu$ V (emf))*

*$K_0$ : antenna calibration factor (dB)*

*In this case, press [F6] function key to select UNIT dB $\mu$ e, and measure the received signal by dB $\mu$ V (emf).*

## User Antenna Factor Setting, Save/Load to /from a Memory Card

### User Antenna Factor Setting

An user antenna factor can be programmed from a personal computer using RS232C or GPIB interface, or using PTA program. Following is an example of PTA program when programming from PTA.

```

100 ##### Makeup Antenna Factor table #####
110 '----- MP534A -----
120 '
130 DIM UANTDT(200,2)
140 DIM TMPCFS(15),TMP$(50)
150 DIM ANTLBLS(30)
160 HOME & ERASE
170 LOCATE(2,10) & PRINT "Program running"
180 LOCATE(2,11) & PRINT "Please Wait a minute"
190 GOSUB *DTSET
200 GOSUB *SCRDT
210 HOME & ERASE
220 LOCATE(2,10) & PRINT "Finish"
230 STOP
240 '
250 '
260 ##### AntennaFactor data into table #####
270 *SCRDT
280 LOCATE(2,13) & PRINT ANTLBLS
290 WRITE 1000,"UANTF 1"
300 WRITE 1000,"ANTFCLR"
310 '
320 FOR I=0 TO DTSTP
330 L=DTSTP-I
340 LOCATE(5,14) & PRINT L
350 CFDT=UANTDT(I,0)*1E6
360 CRCDT=UANTDT(I,1)
370 TMPIS=STR$(I)
380 TMPCFS=STR$(CFDT)

```

```

390 TMPDTS=STR$(CRCDT)
400 TMP$=","+TMPCFS+" ," +TMPDTS
410 WRITE 1000,"ANTFACT ",I,TMP$
420 NEXT I
430 TMP$="""+ANTLBS+""
440 WRITE 1000,"ANTLABEL 1," ,TMP$
450 '
460 RETURN
470 '
480 '##### Correction data setting #####
490 *DTSET
500 UANTDT(0,0)=23 & UANTDT(0,1)=-10 '----- Freq & Level
510 UANTDT(1,0)=25 & UANTDT(1,1)=-9.6
520 UANTDT(2,0)=26 & UANTDT(2,1)=-9.2
530 UANTDT(3,0)=27 & UANTDT(3,1)=-8.9
540 UANTDT(4,0)=28 & UANTDT(4,1)=-8.6
550 UANTDT(5,0)=29 & UANTDT(5,1)=-8.3
560 UANTDT(6,0)=30 & UANTDT(6,1)=-8.0
570 UANTDT(7,0)=31 & UANTDT(7,1)=-7.7
580 UANTDT(8,0)=32 & UANTDT(8,1)=-7.4
590 UANTDT(9,0)=33 & UANTDT(9,1)=-7.1
600 UANTDT(10,0)=34 & UANTDT(10,1)=-6.9
610 UANTDT(11,0)=35 & UANTDT(11,1)=-6.6
620 UANTDT(12,0)=36 & UANTDT(12,1)=-6.3
630 UANTDT(13,0)=37 & UANTDT(13,1)=-6.1
640 UANTDT(14,0)=38 & UANTDT(14,1)=-5.9
650 UANTDT(15,0)=39 & UANTDT(15,1)=-5.7
660 UANTDT(16,0)=40 & UANTDT(16,1)=-5.4
670 UANTDT(17,0)=41 & UANTDT(17,1)=-5.1
680 UANTDT(18,0)=42 & UANTDT(18,1)=-5.0
690 UANTDT(19,0)=43 & UANTDT(19,1)=-4.8
700 UANTDT(20,0)=44 & UANTDT(20,1)=-4.6
710 UANTDT(21,0)=45 & UANTDT(21,1)=-4.4
720 UANTDT(22,0)=46 & UANTDT(22,1)=-4.2
730 UANTDT(23,0)=47 & UANTDT(23,1)=-4.0
740 UANTDT(24,0)=48 & UANTDT(24,1)=-3.8
750 UANTDT(25,0)=49 & UANTDT(25,1)=-3.6
760 UANTDT(26,0)=50 & UANTDT(26,1)=-3.3
770 UANTDT(27,0)=52 & UANTDT(27,1)=-3.0
780 UANTDT(28,0)=54 & UANTDT(28,1)=-2.7

```

79Ø UANTDT(29,Ø)=56 & UANTDT(29,1)=-2.3  
 80ØØ UANTDT(30,Ø)=58 & UANTDT(30,1)=-1.9  
 81Ø UANTDT(31,Ø)=60 & UANTDT(31,1)=-1.6  
 82Ø UANTDT(32,Ø)=62 & UANTDT(32,1)=-1.4  
 83Ø UANTDT(33,Ø)=64 & UANTDT(33,1)=-1.2  
 84Ø UANTDT(34,Ø)=66 & UANTDT(34,1)=-Ø.8  
 85Ø UANTDT(35,Ø)=68 & UANTDT(35,1)=-Ø.5  
 86Ø UANTDT(36,Ø)=70 & UANTDT(36,1)=-Ø.2  
 87Ø UANTDT(37,Ø)=72 & UANTDT(37,1)=Ø.Ø  
 88Ø UANTDT(38,Ø)=74 & UANTDT(38,1)=Ø.2  
 89Ø UANTDT(39,Ø)=76 & UANTDT(39,1)=Ø.5  
 90ØØ UANTDT(40,Ø)=78 & UANTDT(40,1)=Ø.8  
 91Ø UANTDT(41,Ø)=81 & UANTDT(41,1)=1.1  
 92Ø UANTDT(42,Ø)=84 & UANTDT(42,1)=1.3  
 93Ø UANTDT(43,Ø)=86 & UANTDT(43,1)=1.6  
 94Ø UANTDT(44,Ø)=88 & UANTDT(44,1)=1.8  
 95Ø UANTDT(45,Ø)=91 & UANTDT(45,1)=2.1  
 96Ø UANTDT(46,Ø)=94 & UANTDT(46,1)=2.3  
 97Ø UANTDT(47,Ø)=96 & UANTDT(47,1)=2.6  
 98Ø UANTDT(48,Ø)=98 & UANTDT(48,1)=2.8  
 99Ø UANTDT(49,Ø)=101 & UANTDT(49,1)=3.1  
 100ØØ UANTDT(50,Ø)=104 & UANTDT(50,1)=3.3  
 101Ø UANTDT(51,Ø)=106 & UANTDT(51,1)=3.5  
 102Ø UANTDT(52,Ø)=108 & UANTDT(52,1)=3.7  
 103Ø UANTDT(53,Ø)=111 & UANTDT(53,1)=3.9  
 104Ø UANTDT(54,Ø)=114 & UANTDT(54,1)=4.1  
 105Ø UANTDT(55,Ø)=116 & UANTDT(55,1)=4.3  
 106Ø UANTDT(56,Ø)=119 & UANTDT(56,1)=4.5  
 107Ø UANTDT(57,Ø)=121 & UANTDT(57,1)=4.9  
 108Ø UANTDT(58,Ø)=127 & UANTDT(58,1)=5.2  
 109Ø UANTDT(59,Ø)=132 & UANTDT(59,1)=5.6  
 110ØØ UANTDT(60,Ø)=137 & UANTDT(60,1)=5.9  
 111Ø UANTDT(61,Ø)=142 & UANTDT(61,1)=6.3  
 112Ø UANTDT(62,Ø)=147 & UANTDT(62,1)=6.6  
 113Ø UANTDT(63,Ø)=152 & UANTDT(63,1)=6.9  
 114Ø UANTDT(64,Ø)=157 & UANTDT(64,1)=7.2  
 115Ø UANTDT(65,Ø)=162 & UANTDT(65,1)=7.5  
 116Ø UANTDT(66,Ø)=167 & UANTDT(66,1)=7.7  
 117Ø UANTDT(67,Ø)=172 & UANTDT(67,1)=8.Ø  
 118Ø UANTDT(68,Ø)=177 & UANTDT(68,1)=8.3

119Ø UANTDT(69,Ø)=182 & UANTDT(69,1)=8.5  
120Ø UANTDT(70,Ø)=187 & UANTDT(70,1)=8.8  
121Ø UANTDT(71,Ø)=192 & UANTDT(71,1)=9.0  
122Ø UANTDT(72,Ø)=197 & UANTDT(72,1)=9.2  
123Ø UANTDT(73,Ø)=202 & UANTDT(73,1)=9.5  
124Ø UANTDT(74,Ø)=207 & UANTDT(74,1)=9.7  
125Ø UANTDT(75,Ø)=212 & UANTDT(75,1)=9.9  
126Ø UANTDT(76,Ø)=217 & UANTDT(76,1)=10.1  
127Ø UANTDT(77,Ø)=222 & UANTDT(77,1)=10.3  
128Ø UANTDT(78,Ø)=227 & UANTDT(78,1)=10.5  
129Ø UANTDT(79,Ø)=232 & UANTDT(79,1)=10.7  
130Ø UANTDT(80,Ø)=237 & UANTDT(80,1)=10.9  
131Ø UANTDT(81,Ø)=242 & UANTDT(81,1)=11.1  
132Ø UANTDT(82,Ø)=247 & UANTDT(82,1)=11.3  
133Ø UANTDT(83,Ø)=252 & UANTDT(83,1)=11.5  
134Ø UANTDT(84,Ø)=257 & UANTDT(84,1)=11.7  
135Ø UANTDT(85,Ø)=262 & UANTDT(85,1)=11.9  
136Ø UANTDT(86,Ø)=267 & UANTDT(86,1)=12.1  
137Ø UANTDT(87,Ø)=272 & UANTDT(87,1)=12.3  
138Ø UANTDT(88,Ø)=277 & UANTDT(88,1)=12.4  
139Ø UANTDT(89,Ø)=282 & UANTDT(89,1)=12.6  
140Ø UANTDT(90,Ø)=287 & UANTDT(90,1)=12.8  
141Ø UANTDT(91,Ø)=292 & UANTDT(91,1)=13.0  
142Ø UANTDT(92,Ø)=297 & UANTDT(92,1)=13.1  
143Ø UANTDT(93,Ø)=302 & UANTDT(93,1)=13.3  
144Ø UANTDT(94,Ø)=307 & UANTDT(94,1)=13.5  
145Ø UANTDT(95,Ø)=312 & UANTDT(95,1)=13.6  
146Ø UANTDT(96,Ø)=317 & UANTDT(96,1)=13.8  
147Ø UANTDT(97,Ø)=322 & UANTDT(97,1)=14.0  
148Ø UANTDT(98,Ø)=327 & UANTDT(98,1)=14.1  
149Ø UANTDT(99,Ø)=332 & UANTDT(99,1)=14.3  
150Ø UANTDT(100,Ø)=337 & UANTDT(100,1)=14.4  
151Ø UANTDT(101,Ø)=342 & UANTDT(101,1)=14.6  
152Ø UANTDT(102,Ø)=347 & UANTDT(102,1)=14.7  
153Ø UANTDT(103,Ø)=352 & UANTDT(103,1)=14.8  
154Ø UANTDT(104,Ø)=357 & UANTDT(104,1)=15.0  
155Ø UANTDT(105,Ø)=362 & UANTDT(105,1)=15.1  
156Ø UANTDT(106,Ø)=367 & UANTDT(106,1)=15.3  
157Ø UANTDT(107,Ø)=372 & UANTDT(107,1)=15.4  
158Ø UANTDT(108,Ø)=377 & UANTDT(108,1)=15.5

159Ø UANTDT(109,Ø)=382 & UANTDT(109,1)=15.7  
 160Ø UANTDT(110,Ø)=387 & UANTDT(110,1)=15.8  
 161Ø UANTDT(111,Ø)=392 & UANTDT(111,1)=15.9  
 162Ø UANTDT(112,Ø)=397 & UANTDT(112,1)=16.1  
 163Ø UANTDT(113,Ø)=402 & UANTDT(113,1)=16.2  
 164Ø UANTDT(114,Ø)=407 & UANTDT(114,1)=16.3  
 165Ø UANTDT(115,Ø)=412 & UANTDT(115,1)=16.4  
 166Ø UANTDT(116,Ø)=417 & UANTDT(116,1)=16.5  
 167Ø UANTDT(117,Ø)=422 & UANTDT(117,1)=16.7  
 168Ø UANTDT(118,Ø)=427 & UANTDT(118,1)=16.8  
 169Ø UANTDT(119,Ø)=432 & UANTDT(119,1)=16.9  
 170Ø UANTDT(120,Ø)=437 & UANTDT(120,1)=17.0  
 171Ø UANTDT(121,Ø)=442 & UANTDT(121,1)=17.1  
 172Ø UANTDT(122,Ø)=447 & UANTDT(122,1)=17.2  
 173Ø UANTDT(123,Ø)=452 & UANTDT(123,1)=17.4  
 174Ø UANTDT(124,Ø)=457 & UANTDT(124,1)=17.5  
 175Ø UANTDT(125,Ø)=462 & UANTDT(125,1)=17.6  
 176Ø UANTDT(126,Ø)=467 & UANTDT(126,1)=17.7  
 177Ø UANTDT(127,Ø)=472 & UANTDT(127,1)=17.8  
 178Ø UANTDT(128,Ø)=477 & UANTDT(128,1)=17.9  
 179Ø UANTDT(129,Ø)=482 & UANTDT(129,1)=18.0  
 180Ø UANTDT(130,Ø)=487 & UANTDT(130,1)=18.1  
 181Ø UANTDT(131,Ø)=492 & UANTDT(131,1)=18.2  
 182Ø UANTDT(132,Ø)=497 & UANTDT(132,1)=18.3  
 183Ø UANTDT(133,Ø)=502 & UANTDT(133,1)=18.4  
 184Ø UANTDT(134,Ø)=507 & UANTDT(134,1)=18.5  
 185Ø UANTDT(135,Ø)=513 & UANTDT(135,1)=18.6  
 186Ø UANTDT(136,Ø)=518 & UANTDT(136,1)=18.7  
 187Ø UANTDT(137,Ø)=520 & UANTDT(137,1)=18.8  
 188Ø DTSTP=137'<----- Number of DATA  
 189Ø ANTLBLS=" MP534A Dipole"<----- Antenna Factor Label  
 190Ø RETURN

By attaching a label to the antenna correction factor, a label such as the name of the antenna can be displayed on the user antenna factor selection menu.

## Save/Load of User antenna factor To/From a Memory Card

The antenna correction factor data programmed from RS232C/GPIB or PTA can be saved in a memory card.  
 The antenna correction factor data saved in the memory card can be reused by loading.

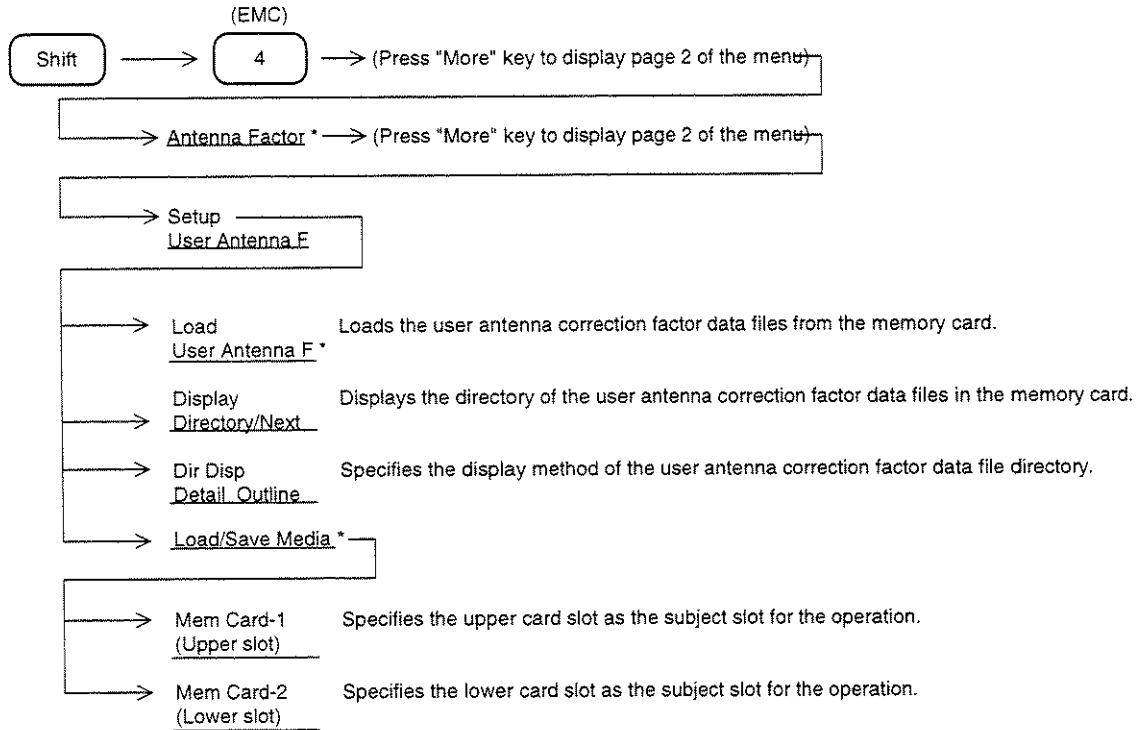



## Caution: When Performing Field Strength Automatic Measurement

When automatically measuring field strength, it is done by RS232C or GPIB control. Since a personal computer is used in such a case, it is necessary to note the following:

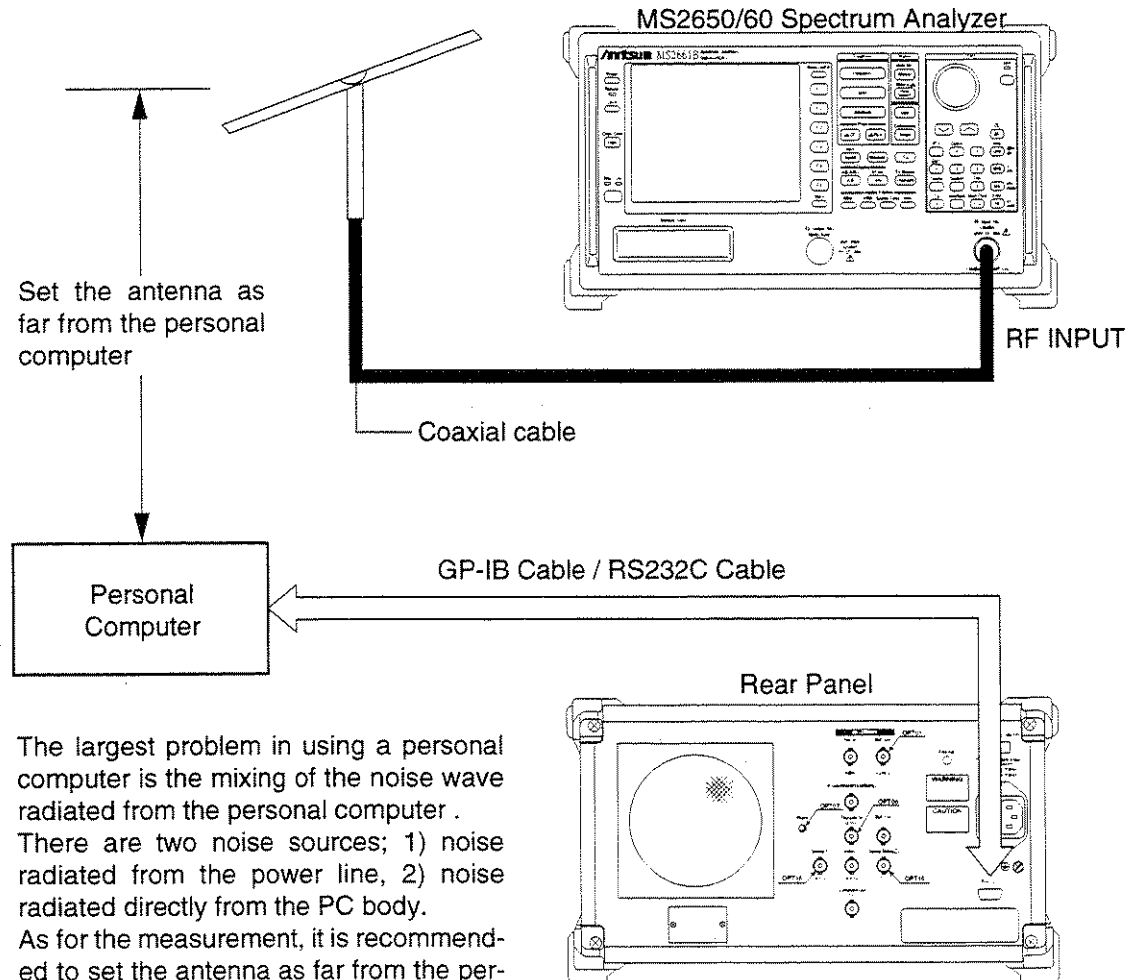

The largest problem in using a personal computer is the mixing of the noise wave radiated from the personal computer. There are two noise sources; 1) noise radiated from the power line, 2) noise radiated directly from the PC body. As for the measurement, it is recommended to set the antenna as far from the personal computer, interface cable, and AC line or the like as possible. Also, utilizing the directivity of antenna, turn the antenna or place the other equipment so as to minimize the reception of the noise.

Caution: When Connecting With a Personal Computer

## EMC Measurement

We often experience difficulties when watching TV or listening radio that the images don't appear properly or the sound is mixed with noise due to electric waves generated by home electrical appliances such as a vacuum cleaner, or information tools such as a personal computer.

Such noise may cause, not only a jam of other equipment, but also a serious accident. Therefore, it has to be controlled EMC (Electro Magnetic Compatibility) by regulations.

As for such regulations, CISPR has made an admonition, and presently, many nations are enforcing the regulations complying this admonition.

This system, by mounting Option 12 or 13, is capable of performing measurements in accordance with this admonition by CISPR.

## Measurement of study

According to its propagation route, jammer is classified into two types, radioactive jammer and conductive jammer. These two types of jammers are measured by QP (Quasi-Peak) value detection and average value detection after selecting measuring frequency range and IF bandwidth as below.

Item	Frequency (IF bandwidth)	Detection mode	Explanation
Radioactive Jammer	10 to 50 kHz (6 dB bandwidth 200 Hz) 150 kHz to 30 MHz(6 dB bandwidth 9 kHz) 30 to 1000 MHz(6 dB bandwidth 120 kHz)	QP Detection	Propagated by radiated into the air, and jams other equipment.
Conductive Jammer	10 to 150 kHz (6 dB bandwidth 200 Hz) 150 kHz to 30 MHz (6 dB bandwidth 9 kHz)	QP Detection Average Detection	Conducted through power lines or connector lines and interferes other equipment.

## Basic Idea of the Measurement

- (1) When combining Peak detection mode and QP (Quasi-Peak) detection mode/Average detection mode to perform an effective measurement of a jammer, there are the following differences between Peak mode and QP/Average mode.

- ① Measured values in QP/Average mode are smaller than that in Peak mode.
- ② Since the charging time constant in QP/Average mode is large, the time required for measurement is much longer than that in Peak mode when performing a frequency sweep.

From the reasons above, it is recommended to combine Peak mode in performing the measurement of jammers.

- (2) Basic Measuring Procedure

- ① Receive the whole aspect of a jammer in Peak mode. (Trace A: frequency axis)
- ② Receive the subject jammer by zero sweep. (Trace Time: time axis)
- ③ Measure the level of the jammer by switching to QP/Average mode.

- (3) Measured Value by Utilizing an Antenna

In measuring a radioactive jammer, the field strength (dB micro/m) of the jammer in (2)③ can be directly read by using a designated antenna. When using an antenna other than the designated antenna, follow the procedure below;

$$\text{Measured Value} = \text{Measured Value of (2)③} - \text{Antenna Factor at Measuring Frequency}$$

By programming the antenna factor into the inner memory of the spectrum analyzer using RS232C or GPIB beforehand, the value can be read directly.

Refer the other for designated/non-designated antennas and field strength measurement itself.

# Radioactive Jammer Measurement

(1) Measuring Block

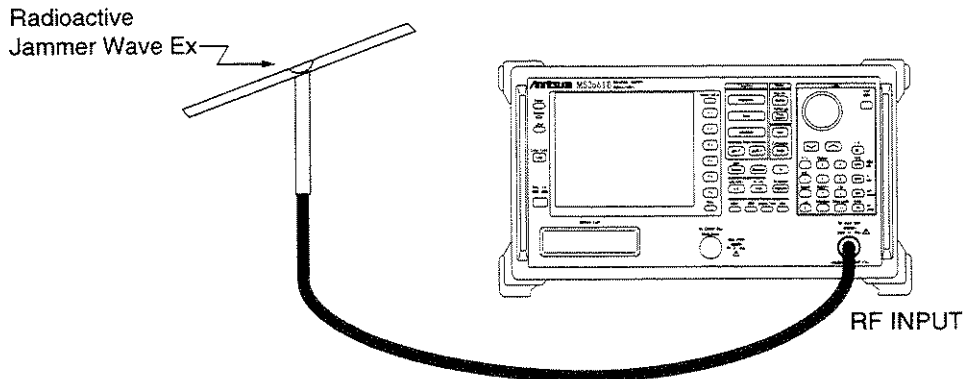

Connect an antenna applicable to the measuring frequency bandwidth to the RF Input of this system.

(2) Measuring Procedure

Preparation

0 QP/EMC Cal :[Shift],[0:Cal],F5:<<QP/EMC Cal>>

Receiving Jammer

1 Preset :[Preset],F1:<<Preset All>>

2 QP/EMC On :Turn On QP/EMC  
[Shift], [4:EMC], F1:<<QP/EMC>>

Turning QP/EMC On will set Log scale at 5 dB/Div, RBW at RBW(120 k Hz) for EMC, and VBW Off.

3 Antenna Correction Factor Selection

:Select the correction factor of an antenna to be used. When the correction of the antenna factor is done by calculation, this step is unnecessary.

Press [More] key to display page 2 of the QP/EMC menu, F1:<<Antenna Factor>>, select an antenna to be used from Antenna F menu, and press F key,

F6:<<return>>.

When one of the antenna correction factor is selected, the level unit is set at "dBμV/m".

3' Setting Level Unit :When the correction of the antenna factor is done by calculation, set the level unit at "dBµV".

Press [More] key to display page 2 of QP/EMC menu, F2:<<Unit>>, F2:<<dBµV>>, F6:<<return>>.

4 Setting Measuring Frequency Band

: Set a measuring frequency band. (i.e. 30 M Hz to 1000 M Hz)[Frequency],F2:<<Start Freq>>,[3],[0],[ M Hz],F2:<<Stop Freq>>, [1], [0], [0],[0], [M Hz]

5 Setting RBW Appropriate to the Frequency Band

: Set RBW. (i.e. 120 k Hz) [Shift],[4:EMC], Press [More] key to display page 1 of QP/EMC menu, F5:<<RBW Manual>>,,[1],[2],[0],[ k Hz]

6 Setting Reference Level

: Set a reference level so as to display the signal with the maximum amplitude near the top line of a waveform indicating scale.

It is done by either method below;

- Press [->RLV]. If the maximum amplitude signal is not indicated near the top line, repeat pressing [->RLV] several times.
- Operate [Amplitude],[^],[V] key/knob to set the reference level at the optimum value.

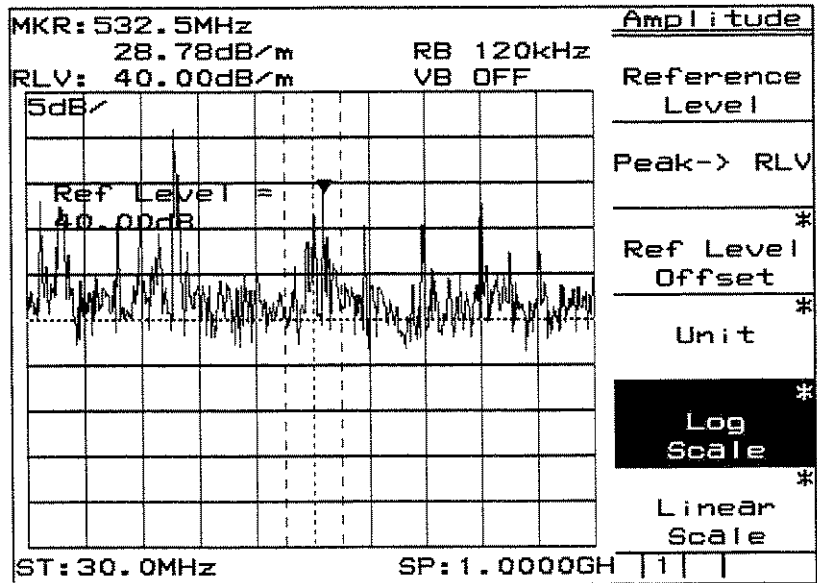

Saturation Level Check

7 Setting Optimum Input Attenuator Value

- : Check that the system is not saturated by lowering the attenuator value by 10 dB. [Atten], Step[V] (Lowers the Attenuator Value by 10 dB)
- If the change in jammer signal presently being observed is 1 dB or less, the saturation has not occurred. When the level change is 1 dB or more, take measurements according to the next clause (1) Response of the Saturation Level.

Tuning Observed Jammer

8 Setting Center Frequency

- : Indicate an observed jammer at the center of waveform indication. [Marker], operate the knob to match the marker to the observed jammer, F6:<<Marker-> >>, F1:<<Mkr->CF>>

9 Narrowing Down Span

- : Narrow down the frequency span to drive in the observed signal. [Span],[V],[->CF] or match the marker to the observed signal, "[Shift],[marker;Marker->],F1:<<Mkr-> CF>>"
- Repeat the above process to narrow the frequency span down to approximately 10 times of RBW.

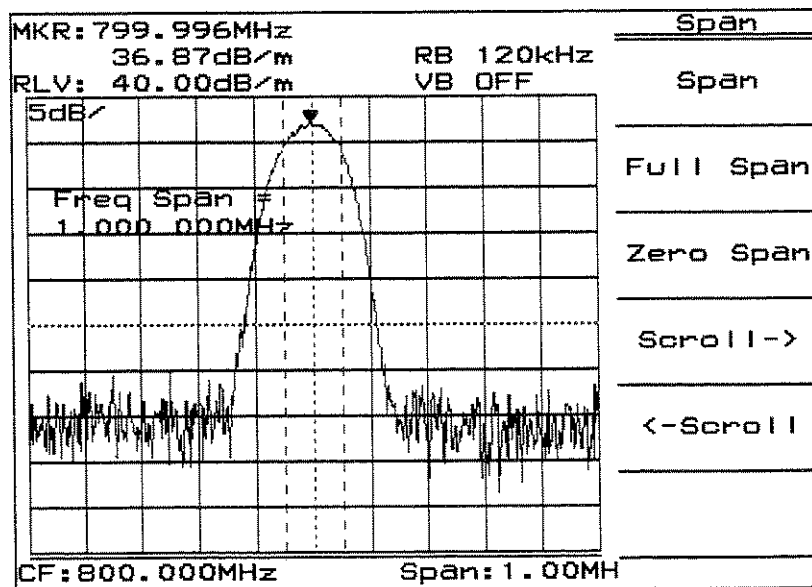

10 Zero Span : Set at Trace-Time (Zero Span Sweep)  
[Time]

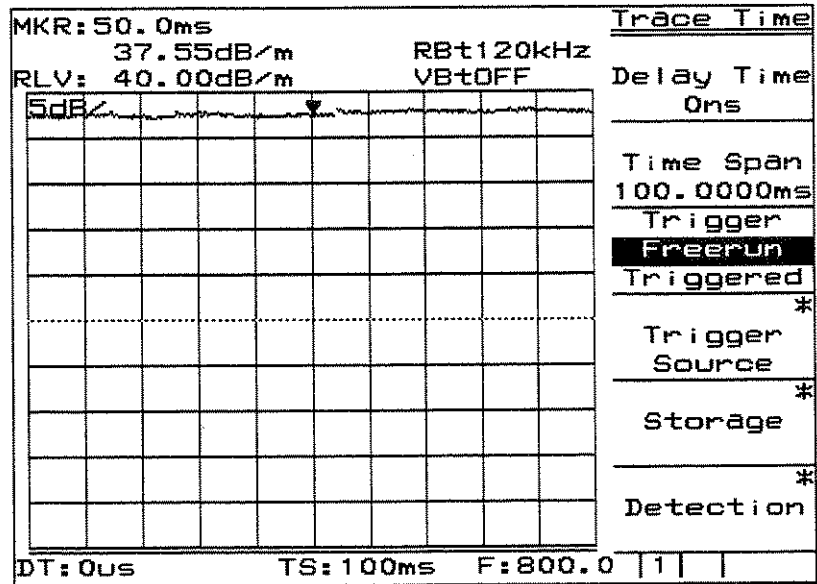

#### Measurement by QP Detector

##### 11 Setting Detection Mode to QP

: [Shift],[4:EMC],F2:<<QP Det>>

##### 12 Adjusting Reference Level

: Adjust the reference level so as to set the level of the observed jammer at -40 dB line from the top of the indication scale.

Operate [Amplitude],[^],[V] key/knob to adjust the reference level.

At this time, make sure that the attenuator value does not vary. When the attenuator value varies, bring the attenuator value back to the value which has been the original set point before the reference level adjustment. When the attenuator value cannot be brought back, be aware that S/N degrades by as much as the varied value.

S/N ratio which does not cause a set point error is 12 dB or more.

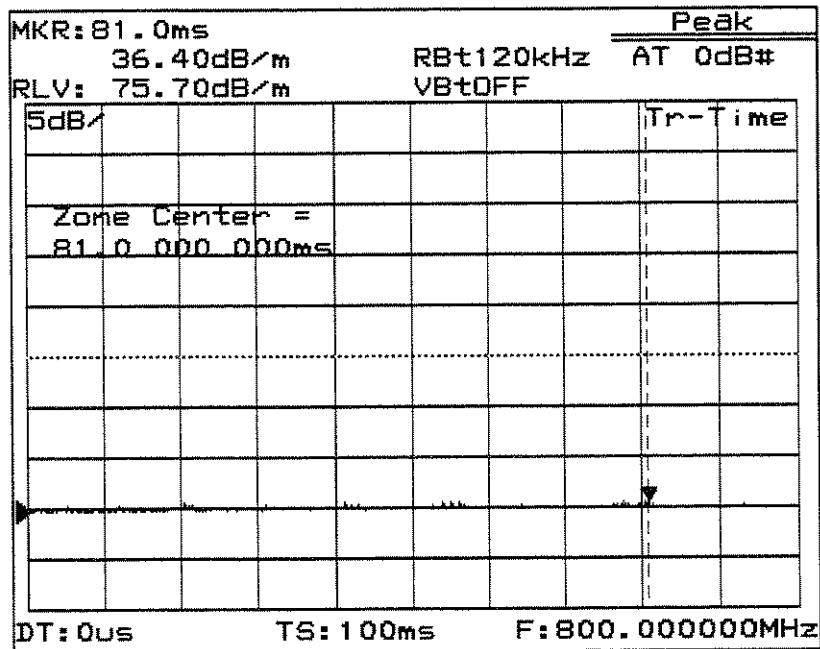

- 13 Level Read-Out : Measurement of maximal level by the marker.  
 Press [Peak] and read the marker level as a measured value.  
 To add antenna factor by calculation, add the correction of the observed frequency to the measured value to obtain the final measured value.

Re-Reception of the Jammer

Use the trace A again to receive the jammer

- 14 Setting Detection Mode to Peak  
 : [Shift],[4:EMC], F4<<Peak Det>>

- 15 Setting at Trace A : Set at Trace A (Frequency axis)  
 [A,B]

Repeat the procedure from 8 to 15 for each jammer



## Conductive Jammer Measurement

### (1) Measuring Block

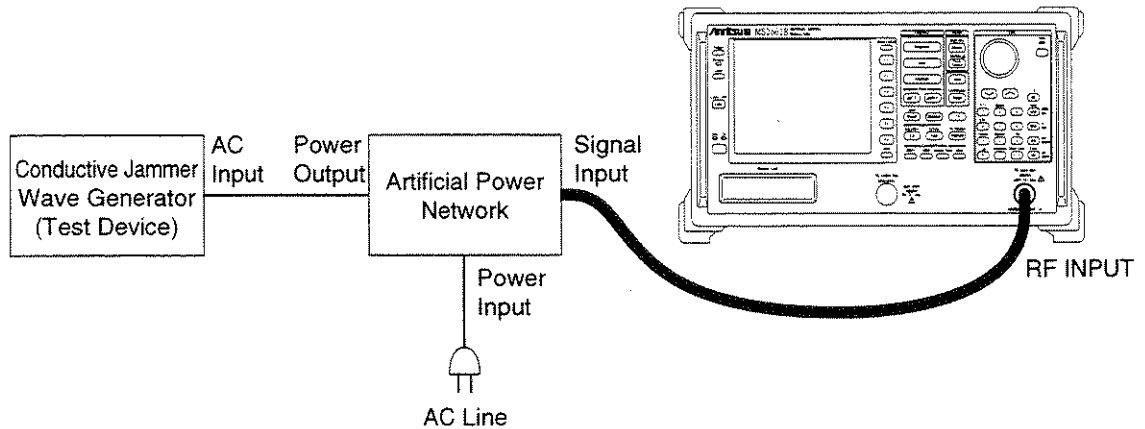

Connect the output from Signal output of an artificial power network to the RF Input of the system.

### (2) Measuring Procedure

#### Preparation

0 QP/EMC Cal : [Shift],[0:Cal], F5:<<QP/EMC Cal>>

#### Receiving Jammer

1 Preset : [Preset], F1:<<Preset All>>

2 QP/EMC On : Turn QP/EMC On  
[Shift],[4:EMC], F1:<<QP/EMC>>  
Turning QP/EMC On will set Log scale at 5 dB/Div, RBW at RBW(120 k Hz) for EMC, and VBW Off.

3 Setting Level Unit : Set the level unit at "dB $\mu$ V".  
Press [More] key to display page 2 of QP/EMC menu. F2:<<Unit>>,  
F2:<<dB $\mu$ V>>, F6:<<return>>.

4 Setting Measuring Frequency Band : Set a measuring frequency band. (i.e. 150 k Hz to 30 M Hz)  
[Frequency],F2:<<Start Freq>>,[1],[5],[0],[ k Hz].F2<<Stop Freq>>,[3],[0],[ M Hz]

5 Setting RBW Appropriate to the Frequency Band

- : Set RBW. (i.e. 9 k Hz)  
[Shift],[4:EMC], Press [More] key to display page 1 of QP/EMC menu,  
F5:<<RBW Manual>>,[9],[ k Hz]

6 Setting Reference Level

- : Set a reference level so as to display the signal with the maximum amplitude near the top line of a waveform indicating scale.  
It is done by either method below;
  - Press [->RLV]. If the maximum amplitude signal is not indicated near the top line, repeat pressing [->RLV] several times.
  - Operate [Amplitude],[^],[V] key/knob to set the reference level at the optimum value.

Saturation Level Check

7 Setting Optimum Input Attenuator Value

- : Check that the system is not saturated by lowering the attenuator value by 10 dB.  
[Atten], Step[V] (Lowers the Attenuator Value by 10 dB)  
If the change in jammer signal presently being observed is 1 dB or less, the saturation has not occurred. When the level change is 1 dB or more, take measurements according to the next clause (1) . Response of the Saturation Level.

Tuning Observed Jammer

8 Setting Center Frequency

- : Indicate an observed jammer at the center of waveform indication.  
[Marker], maneuver the knob to match the marker to the observed jammer,  
F6:<<Marker-> >>, F1:<<Mkr->CF>>

9 Narrowing Down Span

- : Narrow down the frequency span to drive in the observed signal.  
[Span],[V],[->CF] or match the marker to the observed signal,  
"[Shift],[marker;Marker->],F1:<<Mkr-> CF>>"  
Repeat the above process to narrow the frequency span down to approximately 10 times of RBW.

10 Zero Span

- : Set at Trace-Time (Zero Span Sweep)  
[Time]

Measurement by QP Detector

## 11 Setting Detection Mode to QP

: [Shift],[4:EMC],F2:&lt;&lt;QP Det&gt;&gt;

## 12 Adjusting Reference Level

: Adjust the reference level so as to set the level of the observed jammer at -40 dB line from the top of the indication scale.

Operate [Amplitude],[^],[V] key/knob to adjust the reference level.

At this time, make sure that the attenuator value does not vary. When the attenuator value varies, bring the attenuator value back to the value which has been the original set point before the reference level adjustment. When the attenuator value cannot be brought back, be aware that S/N degrades by as much as the varied value.

S/N ratio which does not cause a set point error is 12 dB or more.

## 13 Level Read-Out : Measurement of maximal level by the marker.

Press [Peak] and read the marker level as a measured value.

Add the frequency band correction data of artificial power network and the measuring system in the observed frequency to the measured value, and set the sum as the final measured value.

Measurement by an Average Detector

## 14 Setting Detection Mode to Average

: [Shift],[4:EMC], F3&lt;&lt;Average Det&gt;&gt;

## 15 Level Read-Out : Measurement of maximal level by the marker.

Press [Peak] and read the marker level as a measured value.

Add the frequency band correction data of artificial power network and the measuring system in the observed frequency to the measured value, and set the sum as the final measured value.

Re-Reception of the Jammer

Use the trace A again to receive the jammer

## 16 Setting Detection Mode to Peak

: [Shift],[4:EMC], F4&lt;&lt;Peak Det&gt;&gt;

## 17 Setting at Trace A : Set at Trace A (Frequency axis)

[A,B]

Repeat the procedure from 8 to 17 for each jammer

## Items to be Noted in Measurement

(1) Consideration on Saturation Level

In the case of receiving strong external waves or inappropriate level setting of the spectrum analyzer, distortion or saturation may occur inside the spectrum analyzer.

This distortion or saturation causes measurement errors. Therefore, consideration on such distortion or saturation level is essential in measuring jammers.

■ About the Use of MN1620A Preselector

When measuring jammers in the open air where external waves are strong, even if the level setting of a spectrum analyzer itself is appropriate, distortion or saturation occurs inside the spectrum analyzer due to the over-input. By this, the subject signal is masked and becomes very difficult to distinguish, resulting in errors in the measurement. In such a case, MN1602A preselector or an equivalent is necessary.

■ About the Level Setting

When the setting of an input attenuator is inappropriate, distortion or saturation occurs in an input mixer or the like. Therefore, it is essential to perform the setting of the input attenuator appropriately.

To check whether the saturation has occurred or not, the following methods are available;

- ① Lower the input attenuator value by 10 dB in Peak mode. At this time, if the change in jammer signal is 1 dB or less, the saturation has not occurred. When the level (In this system, when it comes close to the maximum sensitivity, this setting cannot be done. In such a case, use the next method.)
- ② Insert an attenuator which is capable of varying by 1 dB step, into the input terminal of this system. The one capable of 40 dB attenuation would be sufficient. Study on the relationship between reception level and each 1 dB step attenuation. 1 dB compression level is the lower limit of the saturation level. Up to this level, this system is capable of performing correct measurements.

(2) Measurement of Microwave

The sensitivity of the spectrum analyzer determines the measuring limit.

When sufficient sensitivity to meet CISPR standard cannot be obtained, H shall use Option 08 preamplifier, MH648A preamplifier or MN1602A preselector. In that case, please note that the saturation level of the system degrades by as much as the gain of the amplifier. S/N ratio which does not cause measuring errors is 12 dB or more.

(3) About Frequency Sweep and Sweep Duration

When measuring a jammer in QP mode, it is most desirable to do it by a zero sweep. However, it can be measured by a continuous sweep. In this case, in order to perform correct measurement, the sweep duration has to be long enough. Short sweep duration causes a level error by more than several dB. The reasons of this error are;

- ① Overshoot or ringing occurred in a filter which determines the resolution bandwidth.
- ② Large charge and discharge time constant and indicator time constant of the QP detector resulting in a longer time for obtaining the true value.
- ③ Lower possibility of acquiring pulses at the IF filter when pulse repetition frequency is as low as 1 to 2 Hz.

When measuring the strength of a jammer by sweeping a frequency close to the true value, consider the above and conduct the measurement with sufficient sweeping duration.

(4) About Unnecessary Radiation

Unnecessary radiation from this system is restrained to a sufficiently low level compared to CISPR standard. However, please be aware of the following in connecting peripherals.

① Composite Video (Connecting a Video Plotter)

Separate video signals are supplying clock signals (12.8 M Hz, TTL level) to a video plotter. These signals may be radiated from the body of the video plotter.

Since the bands of composite video signal output terminal and video signals are wide, it is possible that these signals to be radiated from the video plotter.

Therefore, if these radiation may possibly be a problem, do not connect a video plotter or the like.

② Printing Device

When printing by a printer or a plotter, by using a printer or X-y plotter with sufficiently low jammer radiation, and a shield type interface cable, the radiation of jammers can be restrained.

If the radiation from a printer/plotter may possibly be a problem in EMC measuring, do not connect a printer/plotter.

# APPENDIX A

## SOFT-KEY MENU

In this section, soft-key menu functions and its hierarchical system are described using a tree.

### TABLE OF CONTENTS

Soft-key Menu List .....	A-4
Menu Tree .....	A-6

# APPENDIX A

## SOFT-KEY MENU

In this section, soft-key menu functions and its hierarchical system are described using a tree. Matters to be noted about the tree are shown below.

- (1) Panel Key indicates a hard key on the front panel.
- (2) Top menus are the menus at the top level which are displayed on the screen when the panel key is pressed. Lower menus indicates other menus below the top menus.
- (3) When a soft key with an appended asterisk (\*) is pressed in these menus, the menu moves to the lower menu indicated by the arrow symbol (->). However, if any not-supported-function soft key in an Option is pressed, an error message is displayed.
- (4) When the Return key is pressed at a lower menu, the next-higher menu is returned.
- (5) Menus with more than six items are split into several pages.
- (6) The menu page construction and currently-displayed page are indicated in the lower part of the menu. To move to the next page, press the [More] key.
- (7) Panel keys and soft keys prefixed by a sharp symbol (#) at the left of the menu frame, give an outline explanation of the function.

## Soft-key Menu List

Menu	Menu Tree(page/28)	Menu	Menu Tree(page/28)
A) A/B.A/BG	16	G) Gate	18
A/Time	17	Gate Setup	18
ACP Setup1	8	H) Hold Count	15
ACP Setup2	8	I) Impedance	2
ACP Setup3	8	Initialize	27
Adj ch Pwr	8	Interface	23
Amplitude	2	Item	12 , 20
Attenuator	2 , 3	L) LCD Brightness	21
Avg Count	15	Lib Exec	26
B) Burst Pwr	11	Lib File	26
C) C/N Meas	7	Lib Memory	26
Channel Power Measure	8	Lib Prgm	27
Cal	22	Lib Remove	26
Change Clr	21	Lin Scale	2
Check File	26	Line	9 , 10
Copy Cont	20	Load/Save	9 , 10
Copy from	21	Location	20
Correction	2	Log Scale	2
CountSetup	7	Lvl Offset	2
D) Def Files	27	M) Manual Set	4
Def Menus	27	Marker	4
Define	27	Marker->	4 , 5
Define Clr	21	Mask Meas	9
Detection	15 , 17	Measure	7
Dip	5	Media	25 , 27
Directory	25	Media	2 , 9 , 10
Disp Line	2 , 4	Mem Card	25
Display	21	Mkr List	4
E) Edit Menu	27	Move Mask	9
Expand	17	Move Temp	10
F) File Ope	25	Multi Marker	4
FM Monitor	17	N) Noise Meas	7
Format	25		
Freq Count	7		
Frequency	1		



Menu	Menu Tree(page/28)	Menu	Menu Tree(page/28)
Normalize	14	Sweep Time	3
O) OBW Setup	8	Swp Contl	16 , 17
Occ BW	8	System	21
P) Paper Size	20	T) Temp Meas	10
Peak	5	TG	14
Plotter	20	Threshold	5
Pon State	21	Title	24
Pre Ampl	2	Trace A.B	14 , 15
Preset	28	Trace Calc	15
Preslctr	22	Trace Move	15
Printer	20	Trace Time	17 , 18
PTA	25	TrackingAd	14
PTA Lib	26	Trnsformer	2
Q) QP/EMC	24	Trig Ext	18
R) RBW	3	Trig TV	18
Recal Media	12	Trig Video	18
Recall	12	Trigger	18
Ref Line	15	TV Monitor	19
Ref Step	2	U) Units	2
RS232C	24	User1	6
S) Save	13	User2	6
Save Media	13 , 20	User3	6
ScrollStep	1	V) VBW	3
Select	2 , 9 , 10	W) Wide IF	18
Set Date	21	Z) Zone Width	4
Set Time	21		
Setup	2		
Setup Mask	9		
Setup Temp	10		
Source	17 , 18		
Sound	21		
Span	1		
Storage	15 , 17		

# Menu Tree

Menu Tree ( 1/28)

Panel Key ————— Top menu ————— Lower menus —————

Frequency
Center Freq
Start Freq
Stop Freq
Peak ->CF
#1 Auto Tune
#2 CF
Step Size
1

- Set items related to frequency, including the center frequency, start/stop frequency, peak->CF, auto synchronization, frequency scroll step size and scroll step size, etc.

#1 Detects peak point in pre-specified (in BG range) span and automatically tunes the peak signal to the specified span.

#2 Sets frequency step size for changing center frequency.

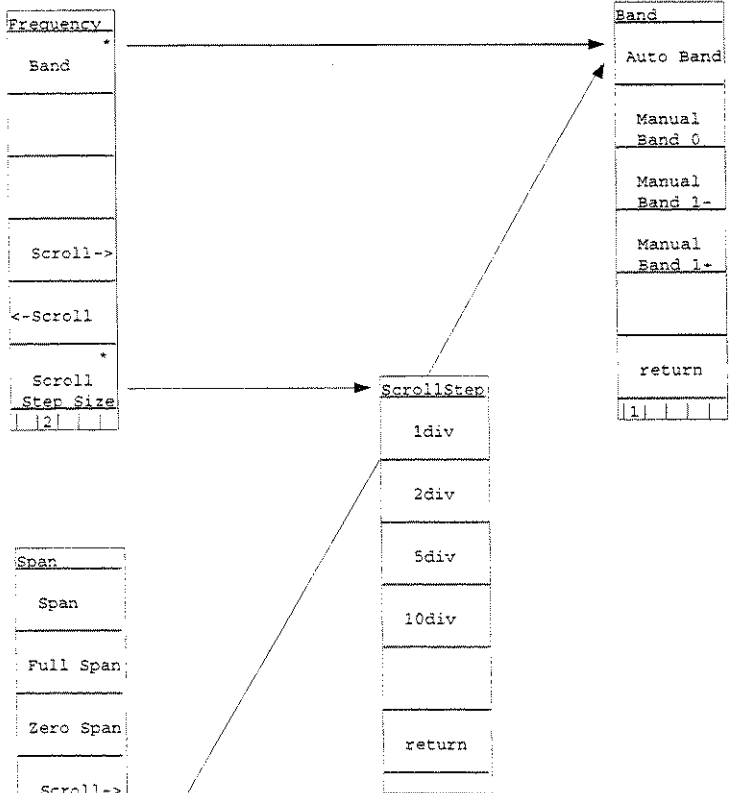

- Set frequency span items, including frequency span, full span, zero span, frequency span scroll, etc.

Menu Tree ( 2/28)

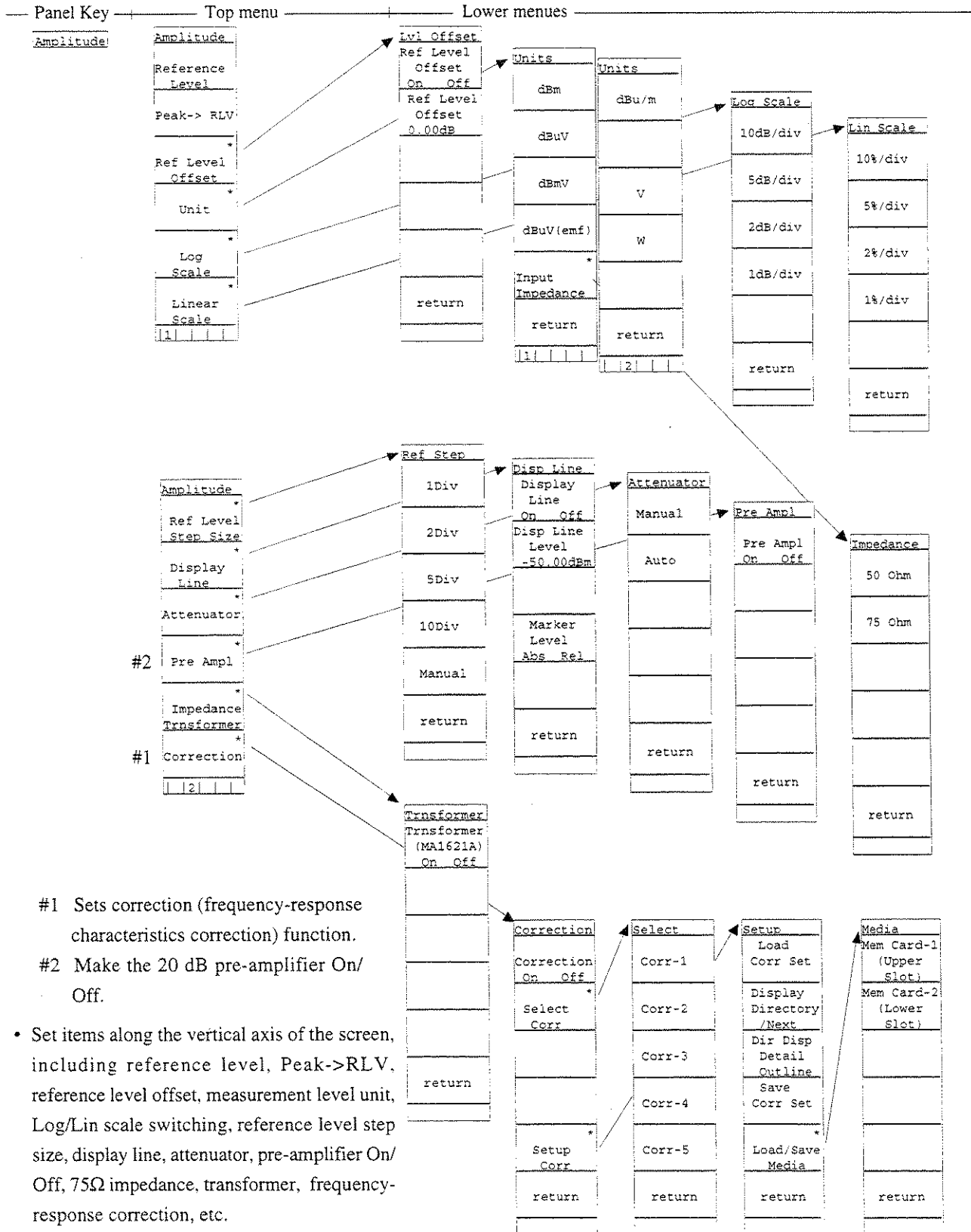

- #1 Sets correction (frequency-response characteristics correction) function.
- #2 Make the 20 dB pre-amplifier On/ Off.

- Set items along the vertical axis of the screen, including reference level, Peak->RLV, reference level offset, measurement level unit, Log/Lin scale switching, reference level step size, display line, attenuator, pre-amplifier On/ Off, 75Ω impedance, transformer, frequency-response correction, etc.

Menu Tree ( 3/28)

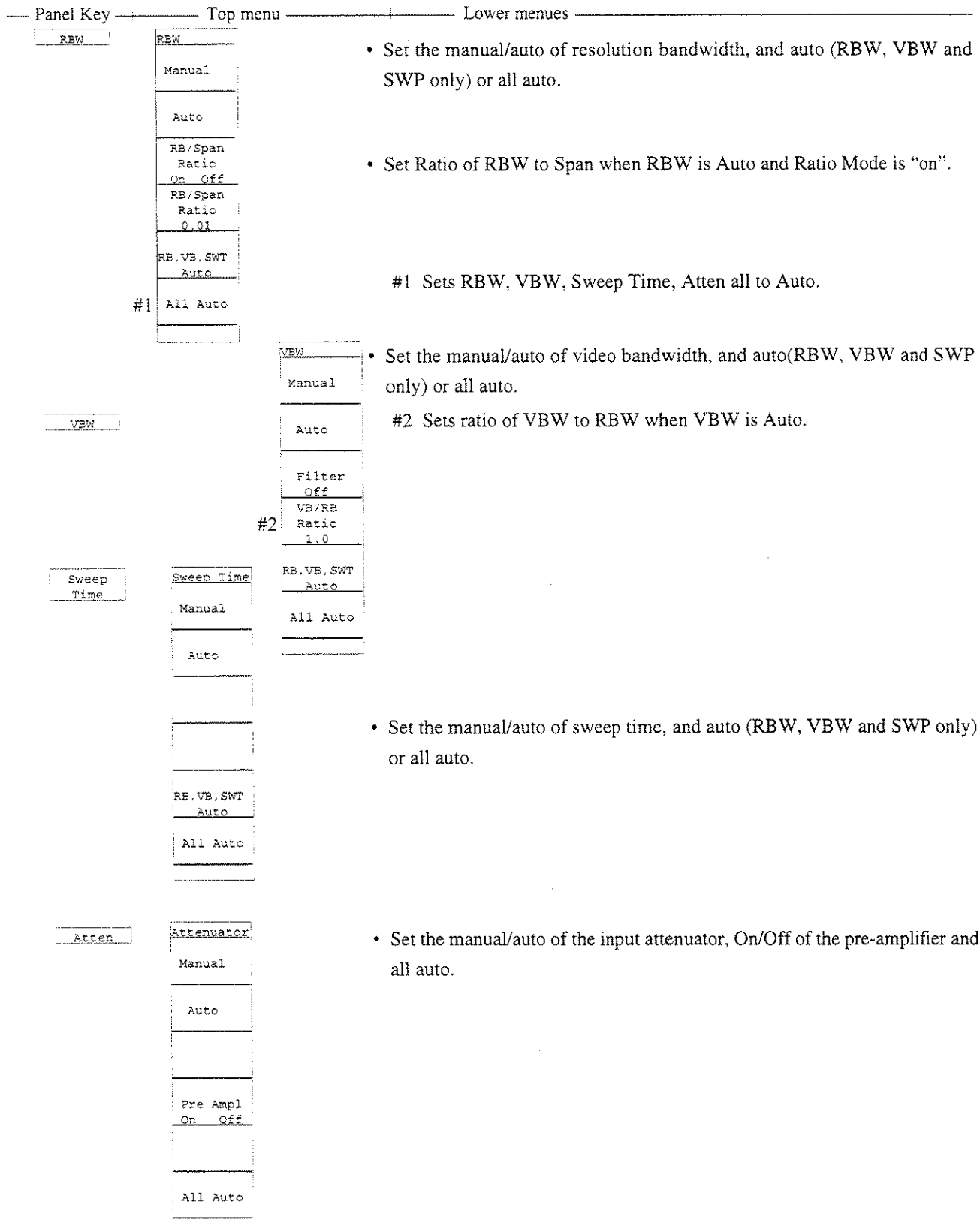

Menu Tree ( 4/28)

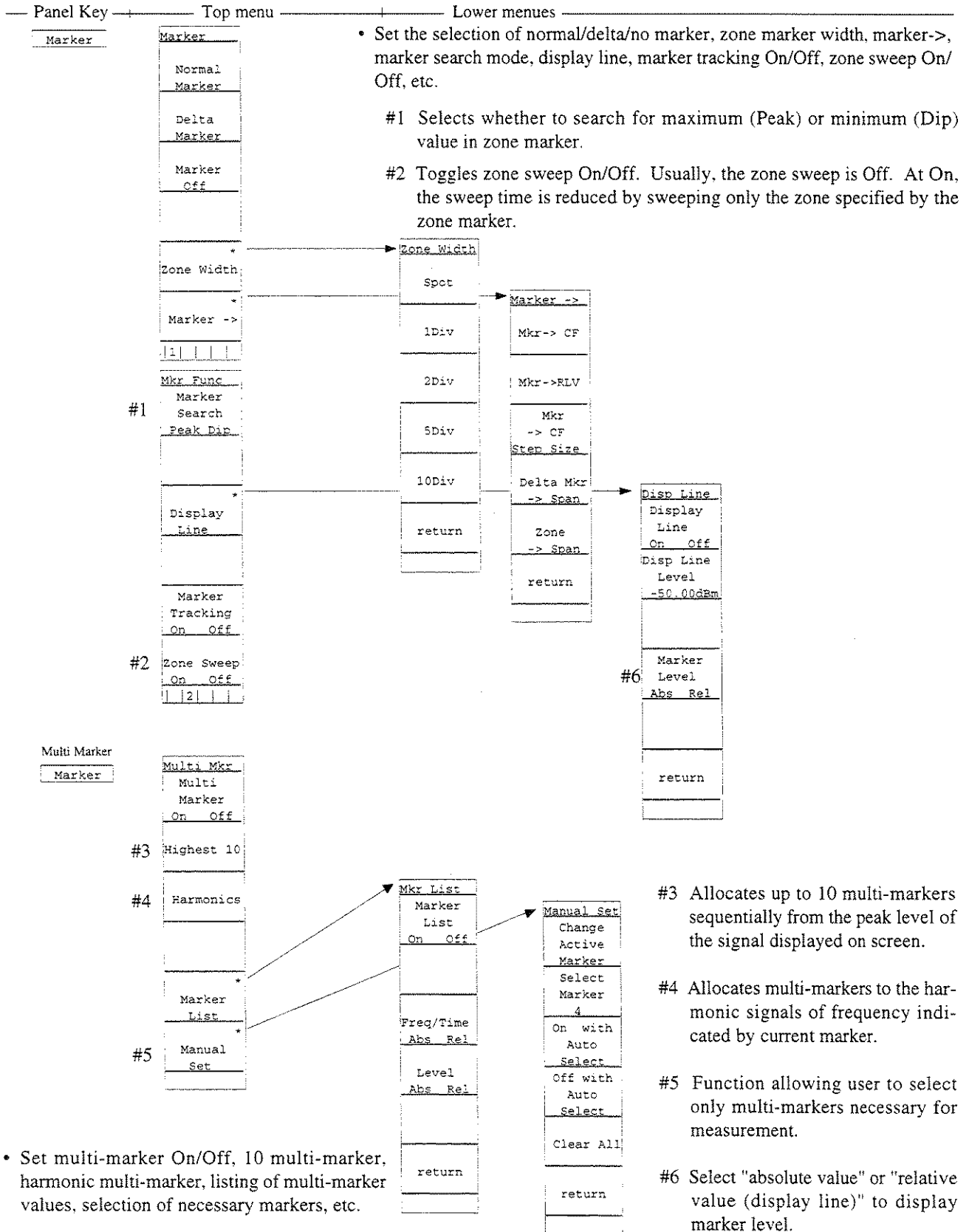

Menu Tree ( 5 /28)

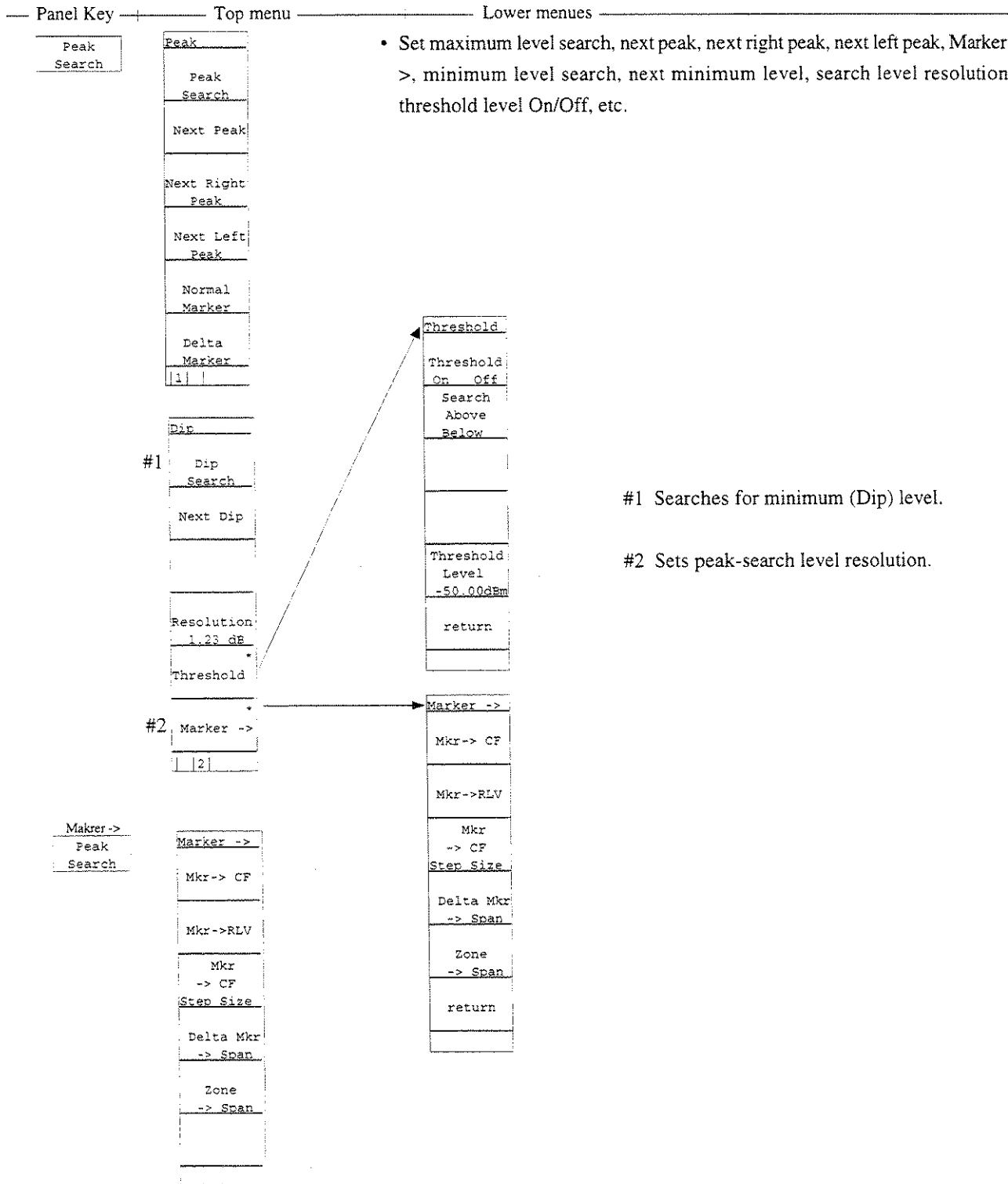

Menu Tree ( 6/28)

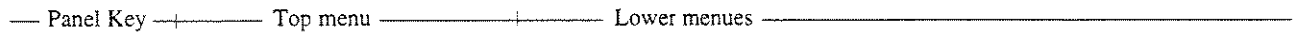

Peak  
→CF

Peak  
→RLV

Single

Continuous  
Single

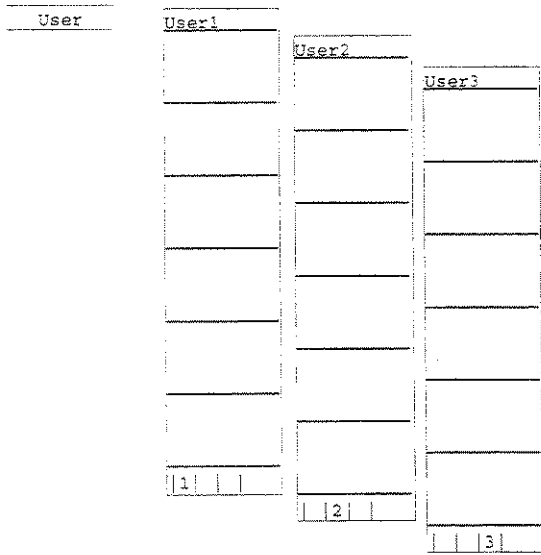

- The soft-key menu defined by the user is displayed. (See "User Define".)

Menu Tree ( 7/28)

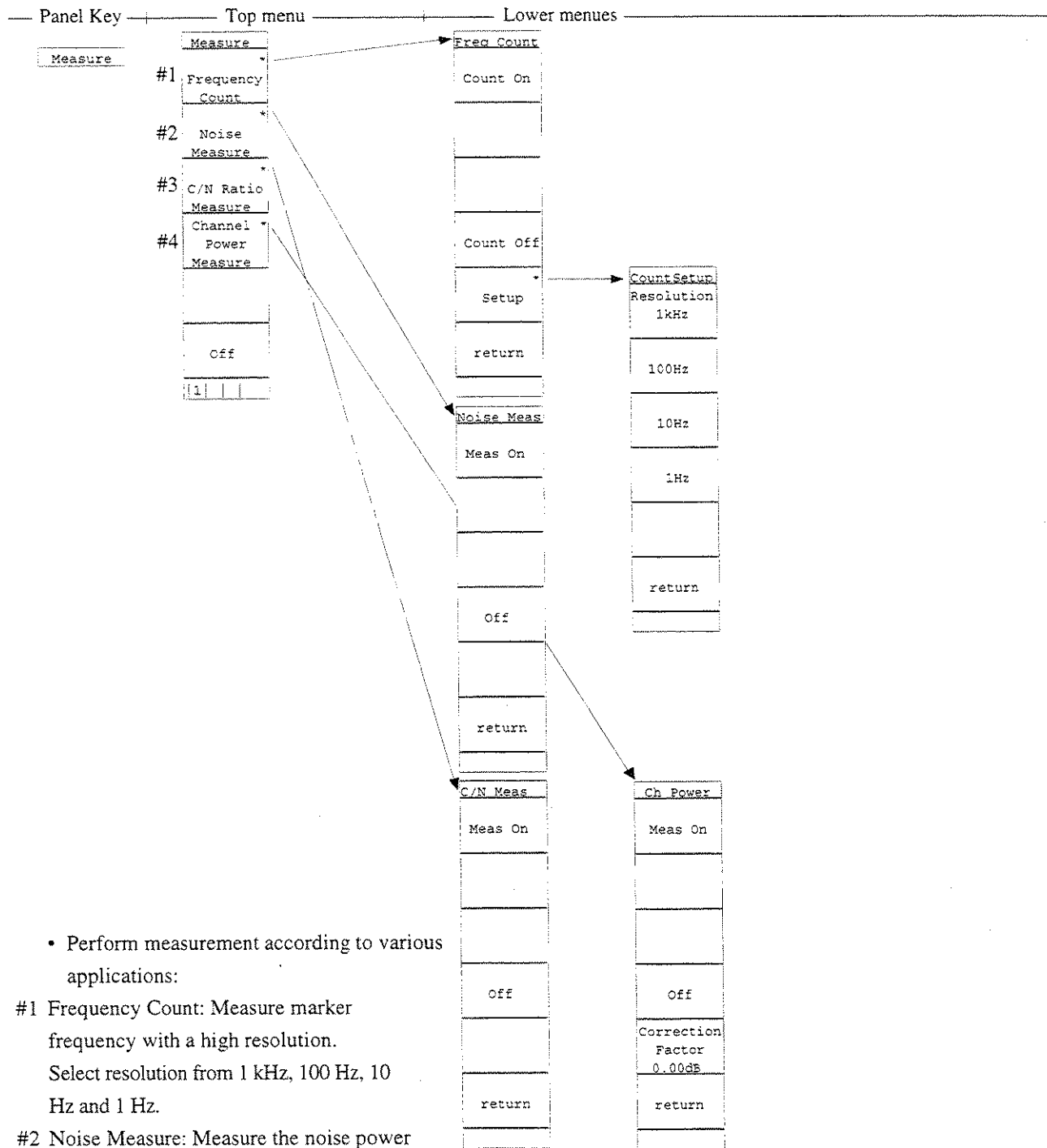

• Perform measurement according to various applications:

#1 Frequency Count: Measure marker frequency with a high resolution.

Select resolution from 1 kHz, 100 Hz, 10 Hz and 1 Hz.

#2 Noise Measure: Measure the noise power within zone marker.

#3 C/N Ratio Measure: Measure the ratio of carrier signal and noise power. Reference marker of the delta marker shall be set to the carrier, and marker's zone width specifies the power measured.

#4 Channel Power Measure: Power with in the band indicated by zone marker is measured. It is possible to set an arbitrary calibration value.



Menu Tree ( 8/28)

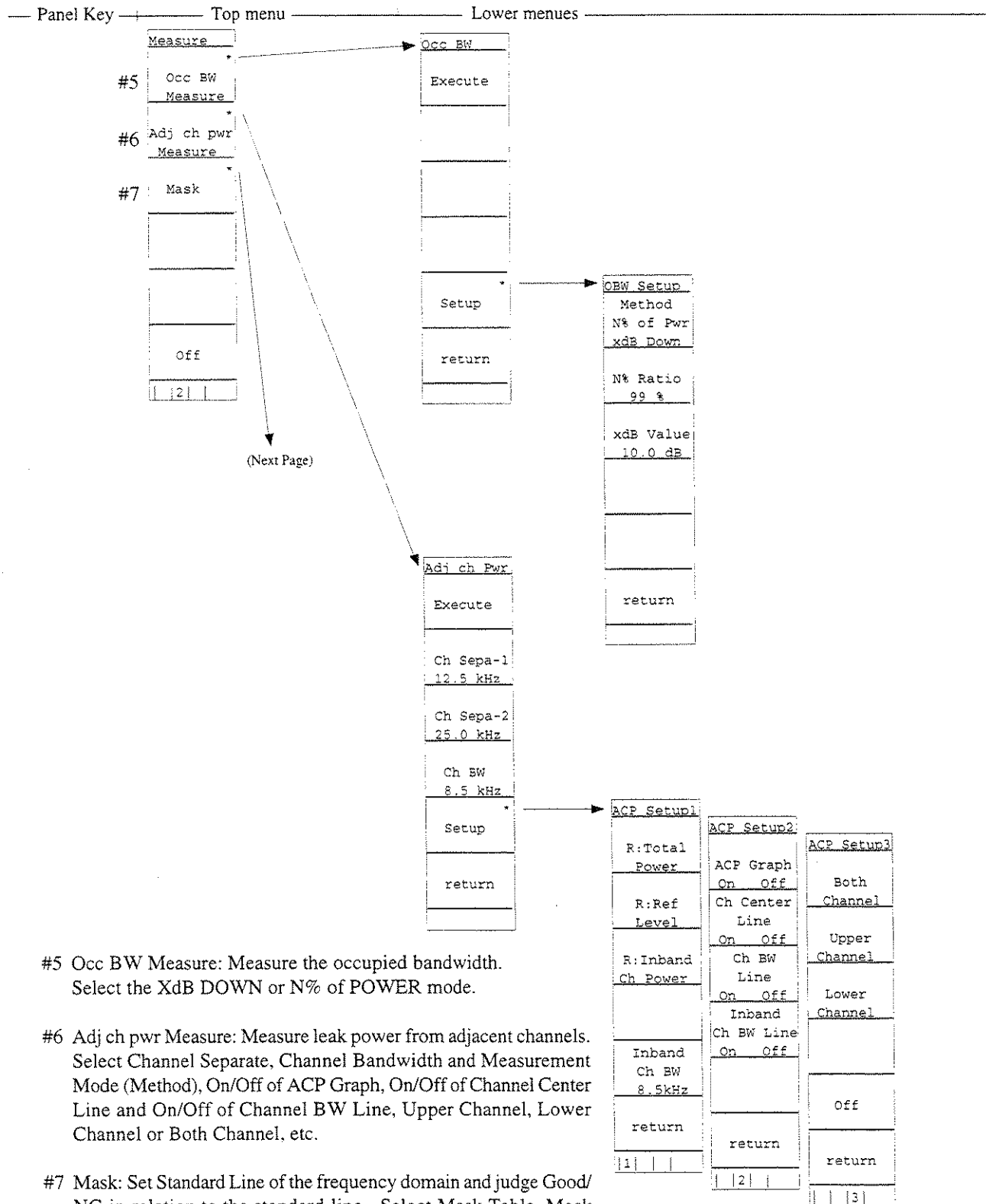

#5 Occ BW Measure: Measure the occupied bandwidth. Select the XdB DOWN or N% of POWER mode.

#6 Adj ch pwr Measure: Measure leak power from adjacent channels. Select Channel Separate, Channel Bandwidth and Measurement Mode (Method), On/Off of ACP Graph, On/Off of Channel Center Line and On/Off of Channel BW Line, Upper Channel, Lower Channel or Both Channel, etc.

#7 Mask: Set Standard Line of the frequency domain and judge Good/NG in relation to the standard line. Select Mask Table, Mask Movement, Measurement Mode, Mask Table Preparation, Load/Save of Mask Table, etc.

Menu Tree ( 9/28)

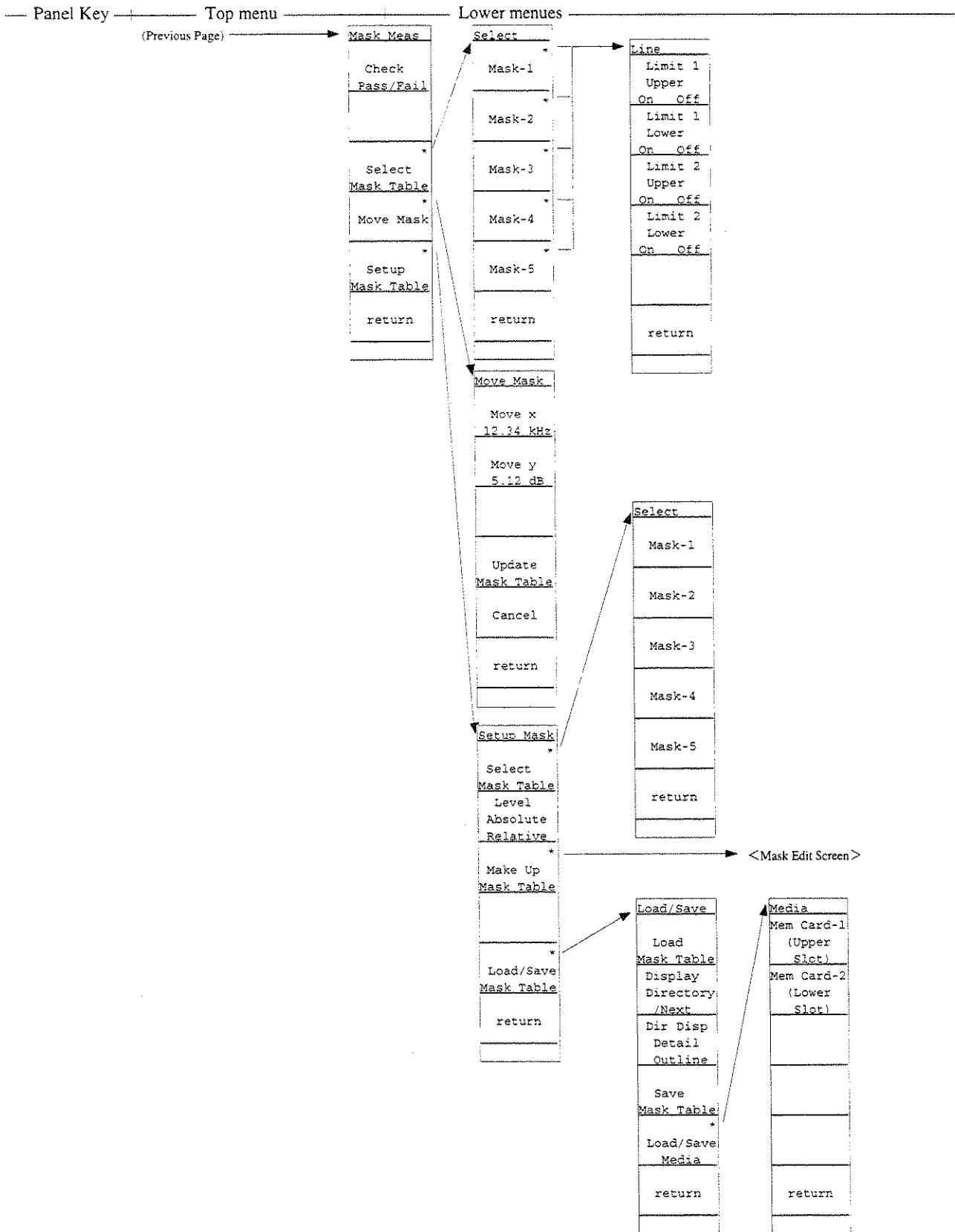

Menu Tree (10/28)

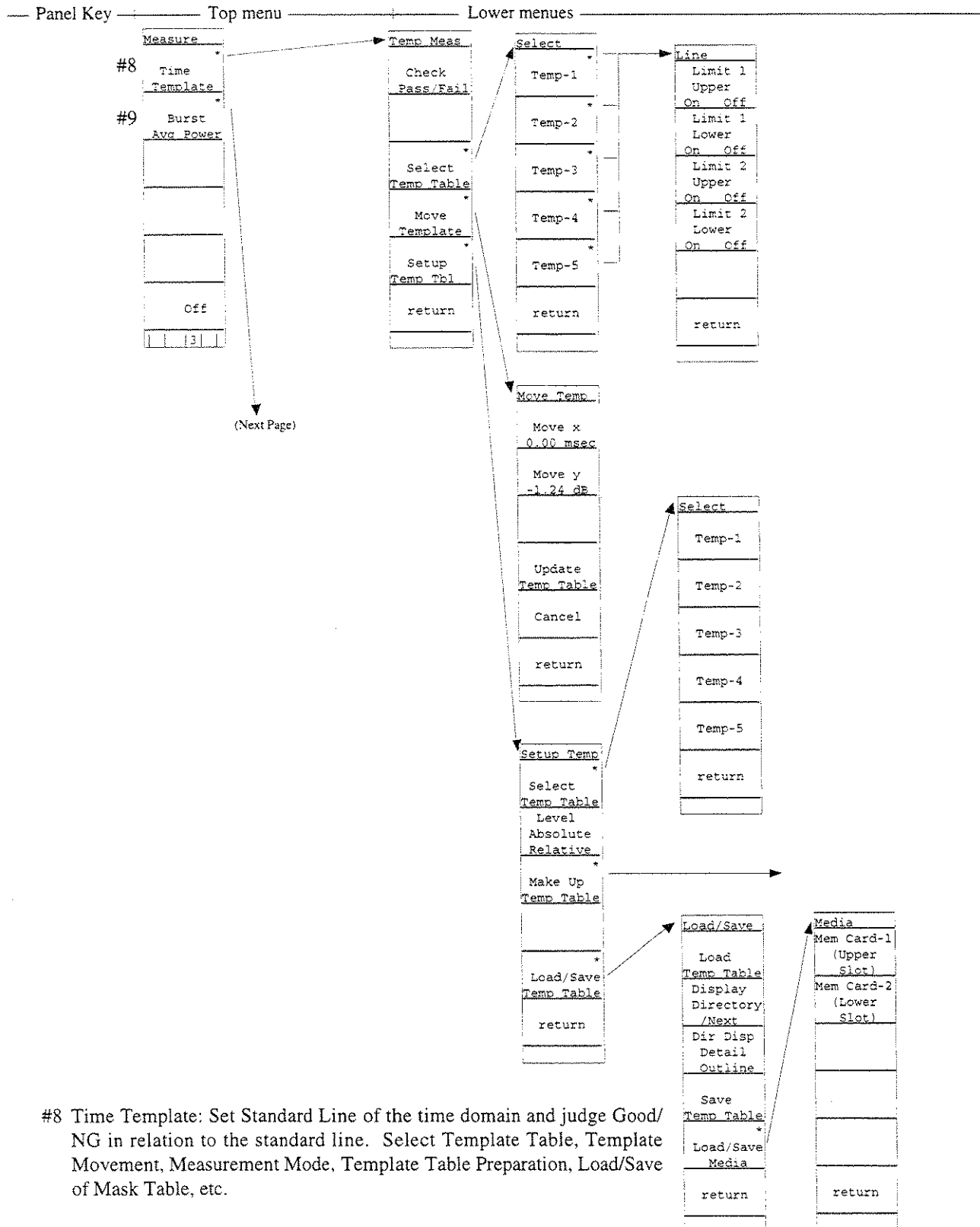

#8 Time Template: Set Standard Line of the time domain and judge Good/NG in relation to the standard line. Select Template Table, Template Movement, Measurement Mode, Template Table Preparation, Load/Save of Mask Table, etc.

#9 Burst Avg Power: Measure the mean power of burst signals in the time domain. Select the start/end points.

Menu Tree (11/28)

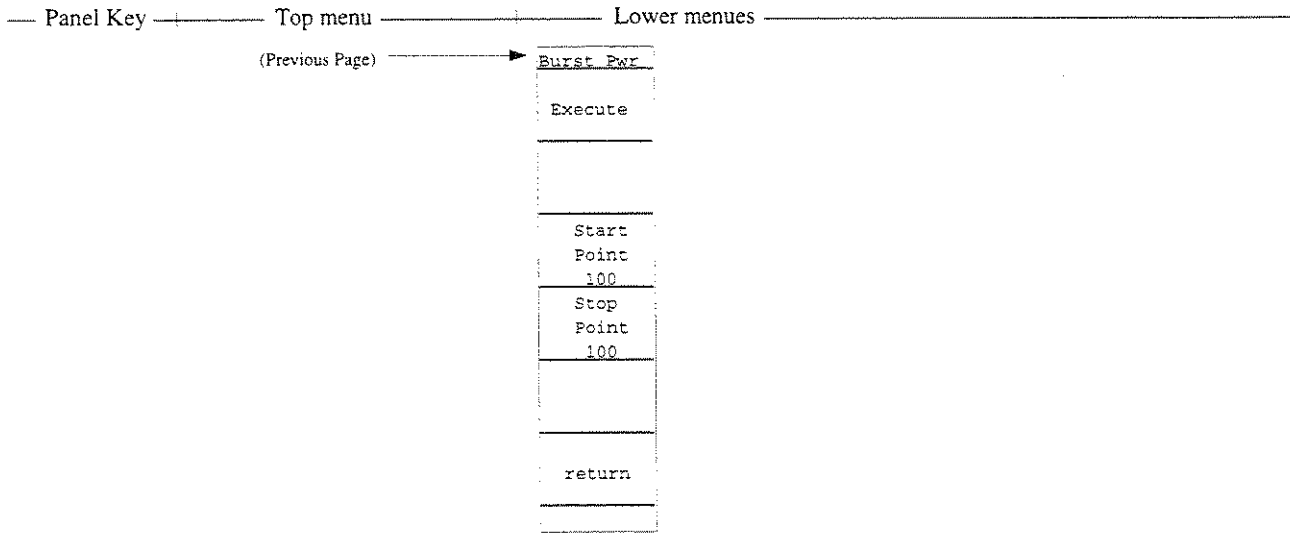

Menu Tree (12/28)

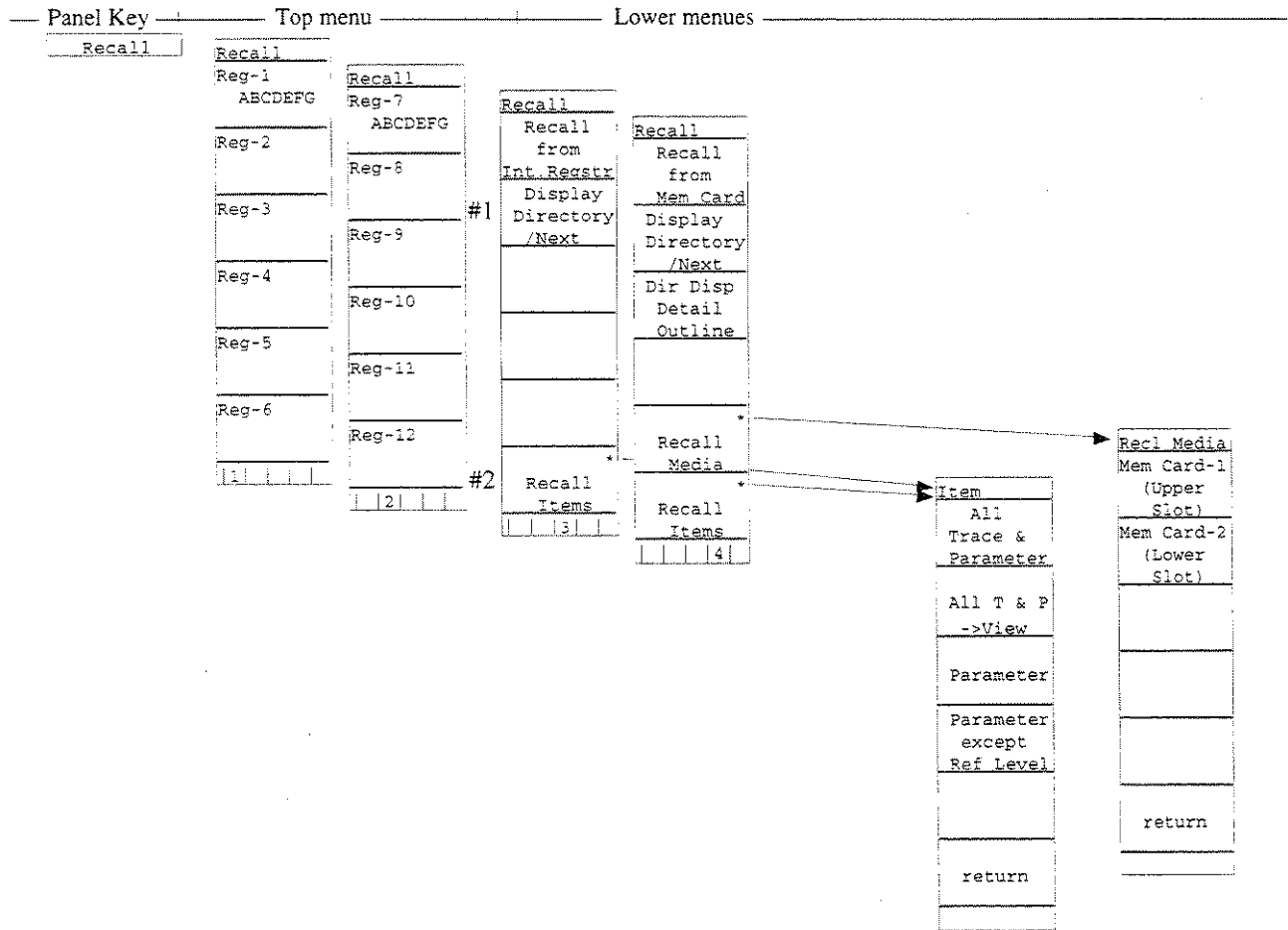

- Read out trace waveform/parameters from the internal memory or memory card. Select recall addresses and media/items, and display file directories.

#1 Displays list of internal-memory directories.

#2 Specifies items to be recalled (trace waveform, parameter, etc.).

Menu Tree (13/28)

Panel Key | Top menu | Lower menus

Save  
Recall

Save  
Save  
to  
Int. Registr.  
Display  
Directory  
/Next  
  
  
  
  
1 | | |

- Save trace waveform/parameters to the internal memory or memory card. Select saved media, and display file directories.

Save  
Save  
to  
Mem Card  
Display  
Directory  
/Next  
Dir Disp  
Detail  
Outline

Save  
Media  
  
2 | | |

Save Media  
Mem Card-1  
(Upper  
Slot)  
Mem Card-2  
(Lower  
Slot)  
  
  
  
return

Save  
Save  
BMP file  
to Memcard  
Display  
Directory  
/Next  
Dir Disp  
Detail  
Outline

Save  
Media  
  
3 | | |

Menu Tree (14/28)

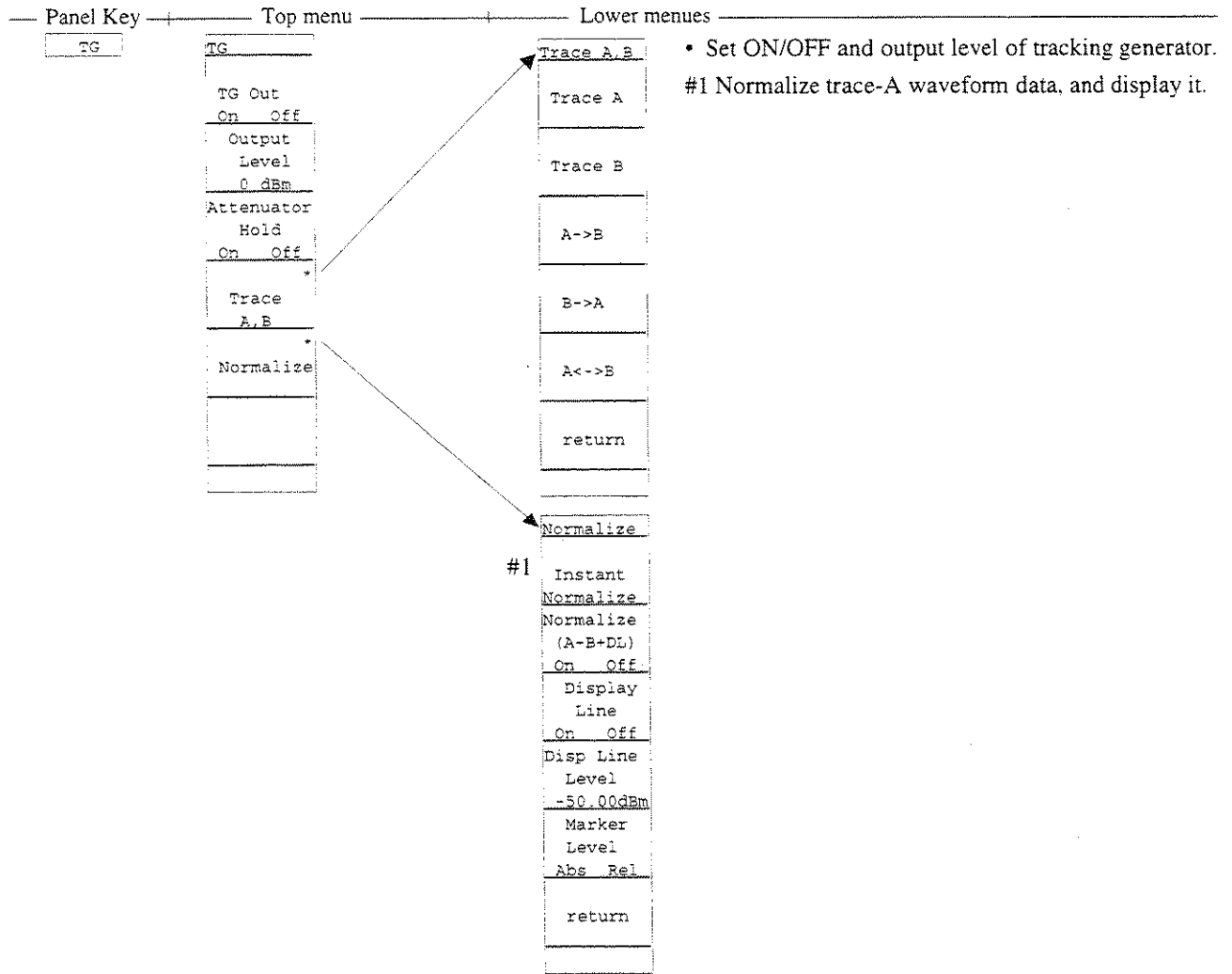

Menu Tree (15/28)

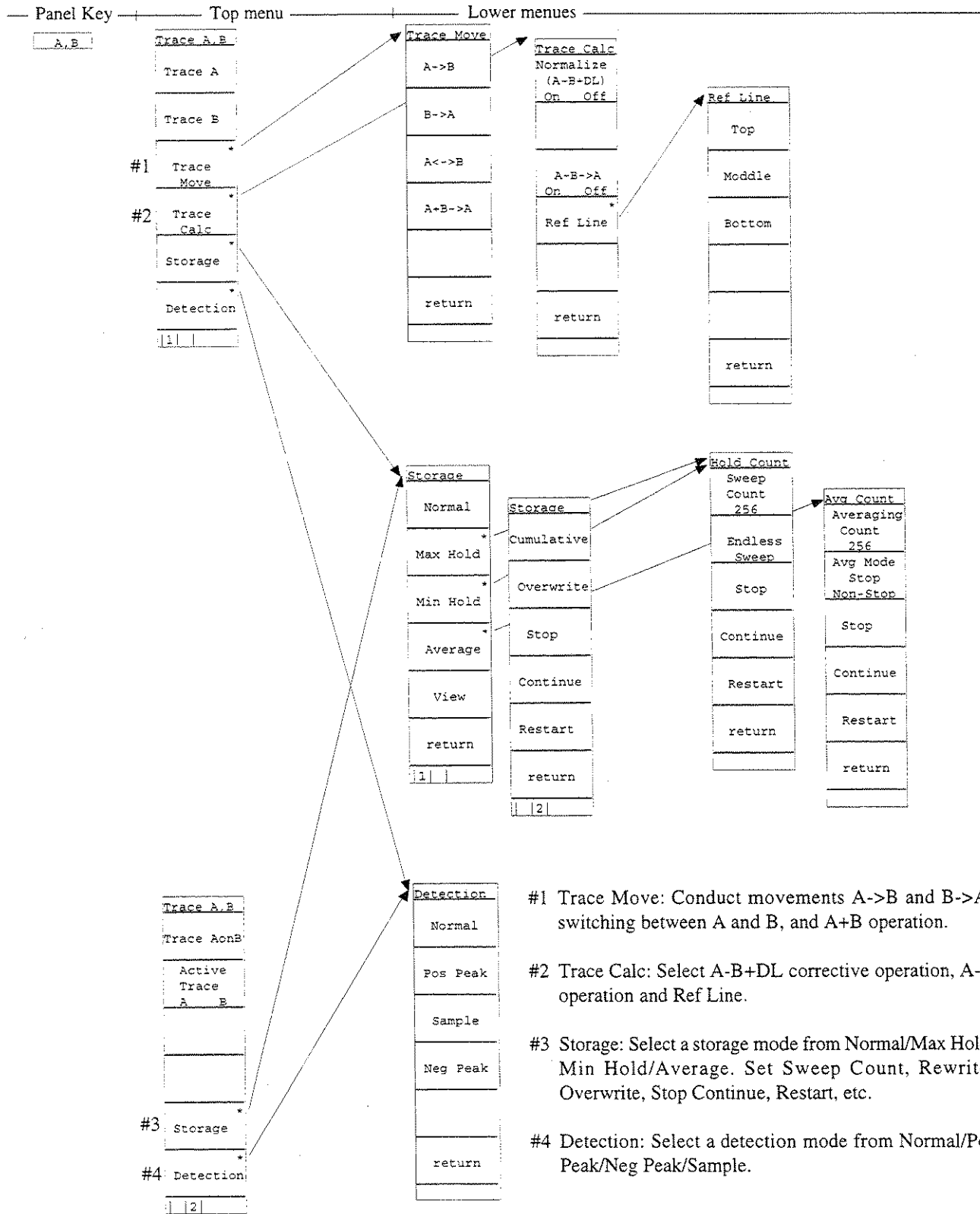

- Select Trace A/B, movement between Trace A/B, sum/difference operation between Trace A/B and Ref Line, and designate the storage and detection modes and Active Trace.



Menu Tree (16/28)

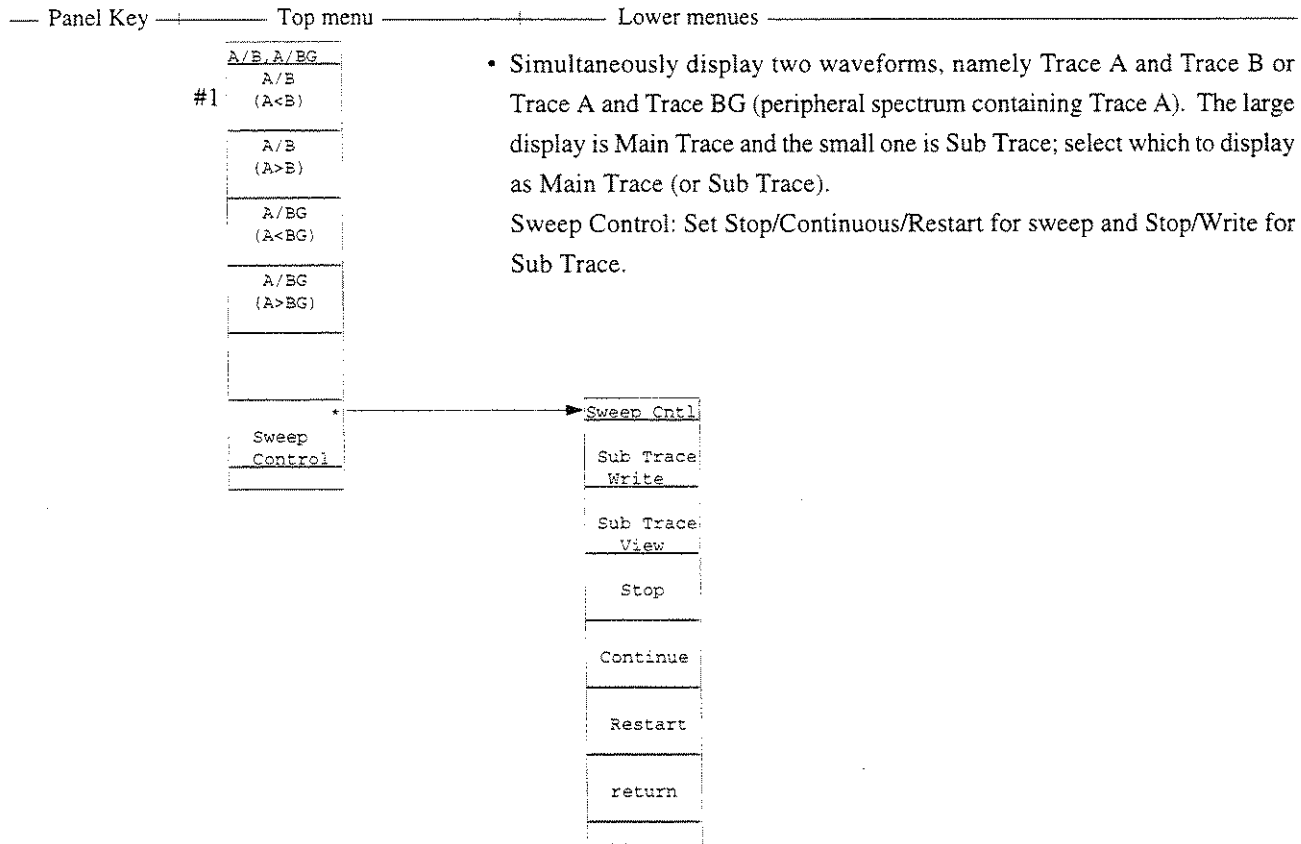

#1 Displays two traces A and B simultaneously at top and bottom of screen. The trace-B display is the larger at this time.

Menu Tree (17/28)

Panel Key ——— Top menu ——— Lower menus

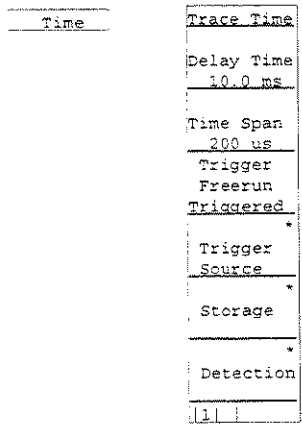

- Set to the zero-span time domain display. Set Time Span, Trigger, Trigger Source, Storage, Detection and FM Monitor On/Off, and select Expand (waveform).

Source (Same as "Trigger Source" menu in Trig/Gate key)

Storage (Same as "Storage Mode" menu in A,B key)

Detection (Same as "Det Mode" menu in A,B key)

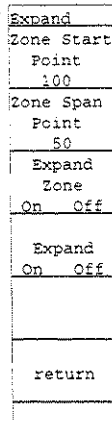
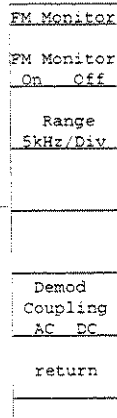
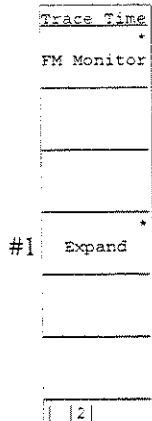

#1 Zooms in time-domain waveform display.

A/Time  
Time

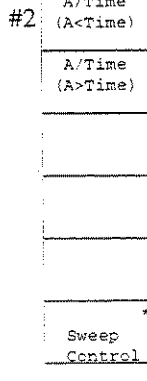

#2 Displays trace-A waveforms in frequency domain and time domain simultaneously at top and bottom of screen. The time-domain display is the larger at this time.

- Simultaneously display waveforms of Trace a and Time Domain. Which to display as Main Trace (or Sub Trace) can be selected.

Menu Tree (18/28)

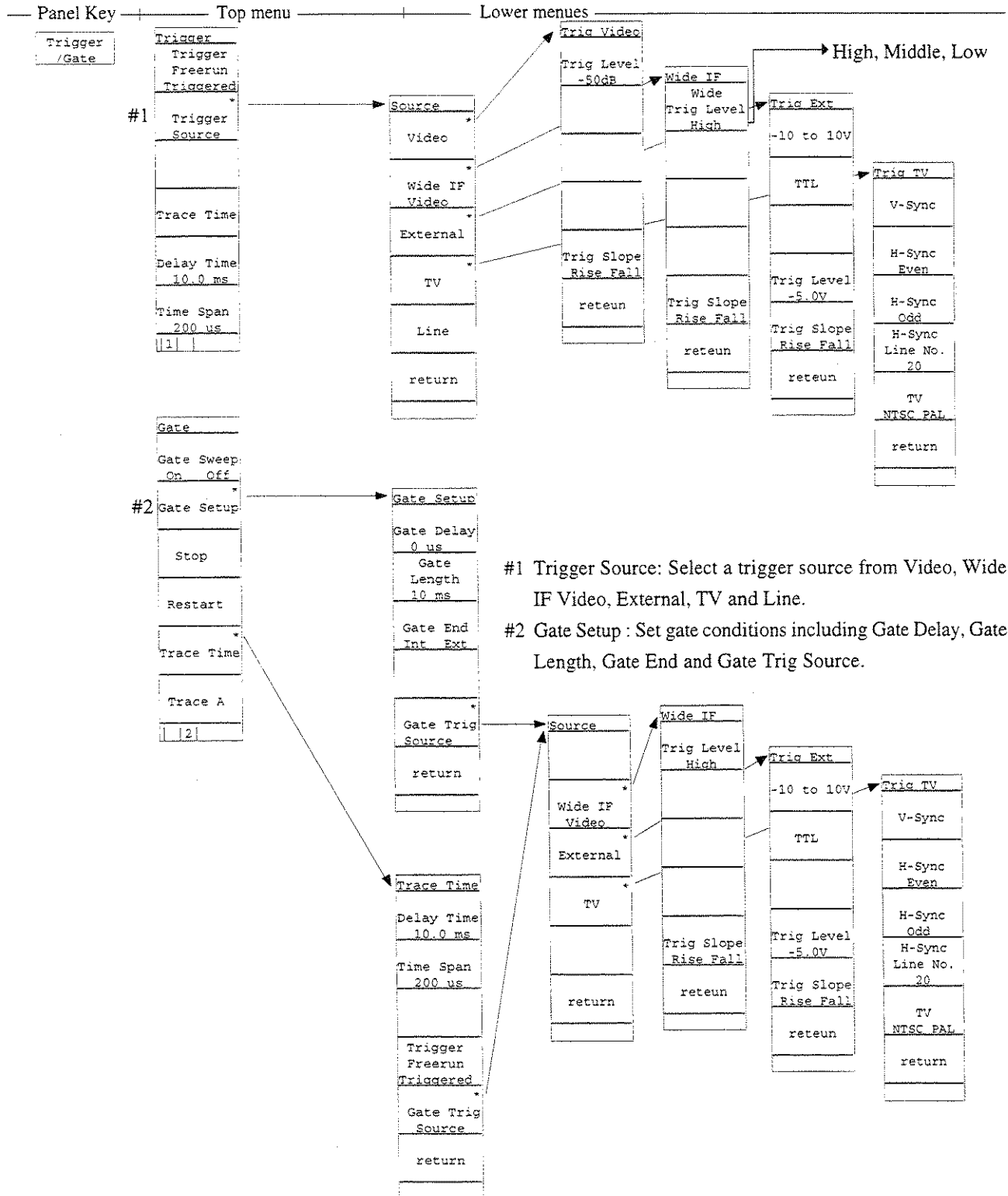

- Set gate functions for controlling the sweep start trigger and the writing of waveform data. Set the trigger mode, trigger source, trace time, delay time and time span. Select On/Off, Stop and Restart of Gate Sweep.

Menu Tree (19/28)

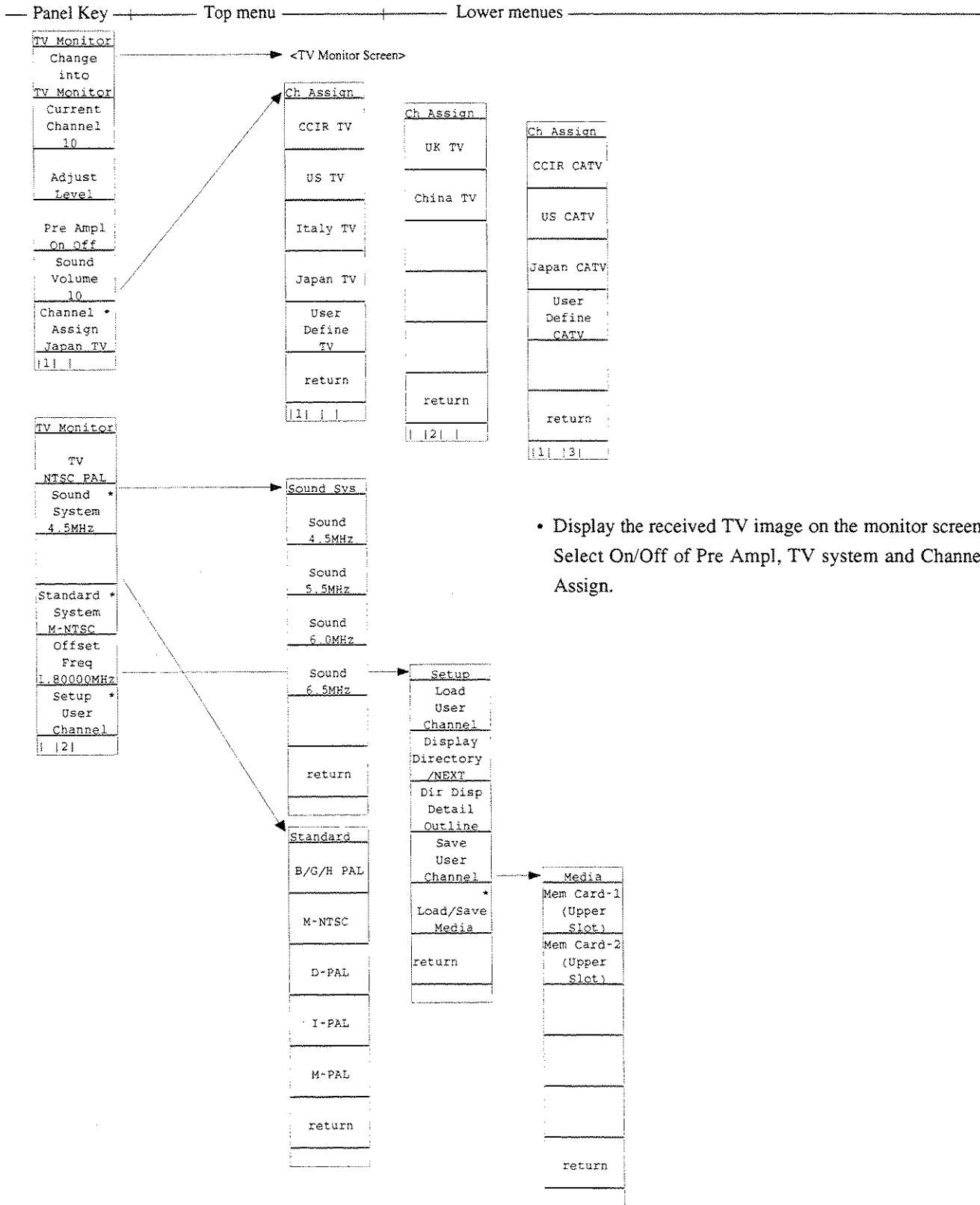

- Display the received TV image on the monitor screen. Select On/Off of Pre Ampl, TV system and Channel Assign.

Menu Tree (20/28)

Panel Key ——— Top menu ——— Lower menus ———

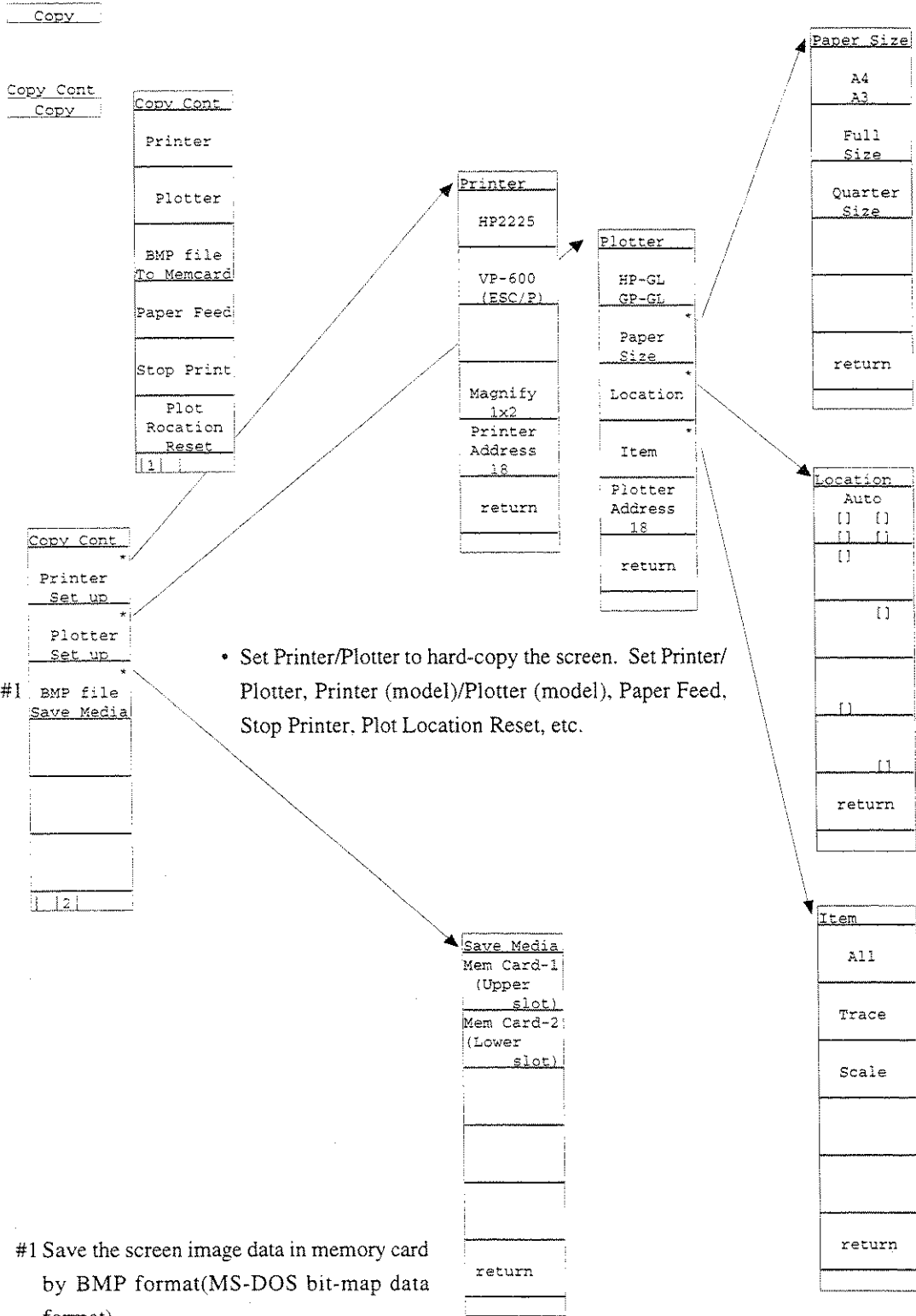

#1 Save the screen image data in memory card by BMP format(MS-DOS bit-map data format).

Menu Tree (21/28)

Panel Key | Top menu | Lower menus

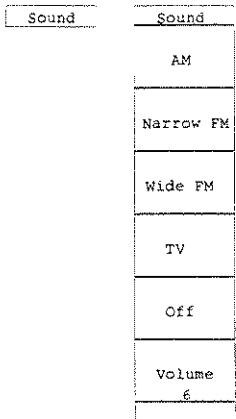

- Demodulate the received signal and monitor-output it from the speaker. Select AM, Narrow FM, Wide FM, TV (voice) and Volume.

#1 Sets whether the coupled settings for RBW, VBW, etc., in frequency and time domain, independent or common.

#2 Changes screen color pattern.

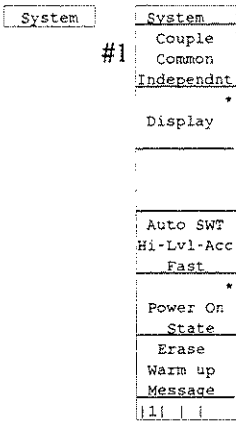

#1

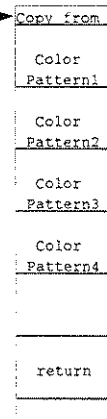
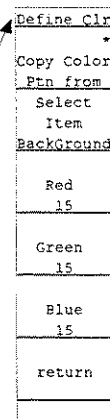
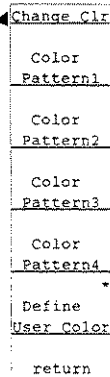

#2

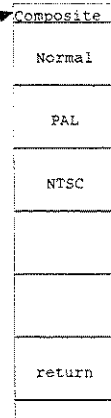
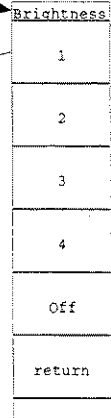
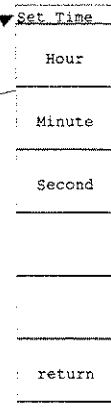
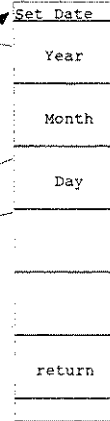
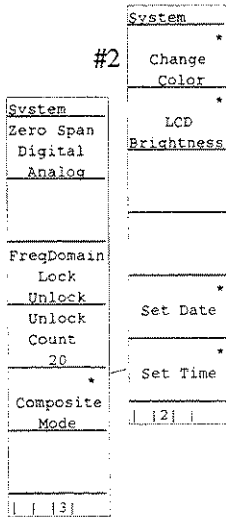

- Set various modes of systems of this device. Set Couple, Display, Color Pattern, Define User Color, Time Sweep, Power On State, etc..

Menu Tree (22/28)

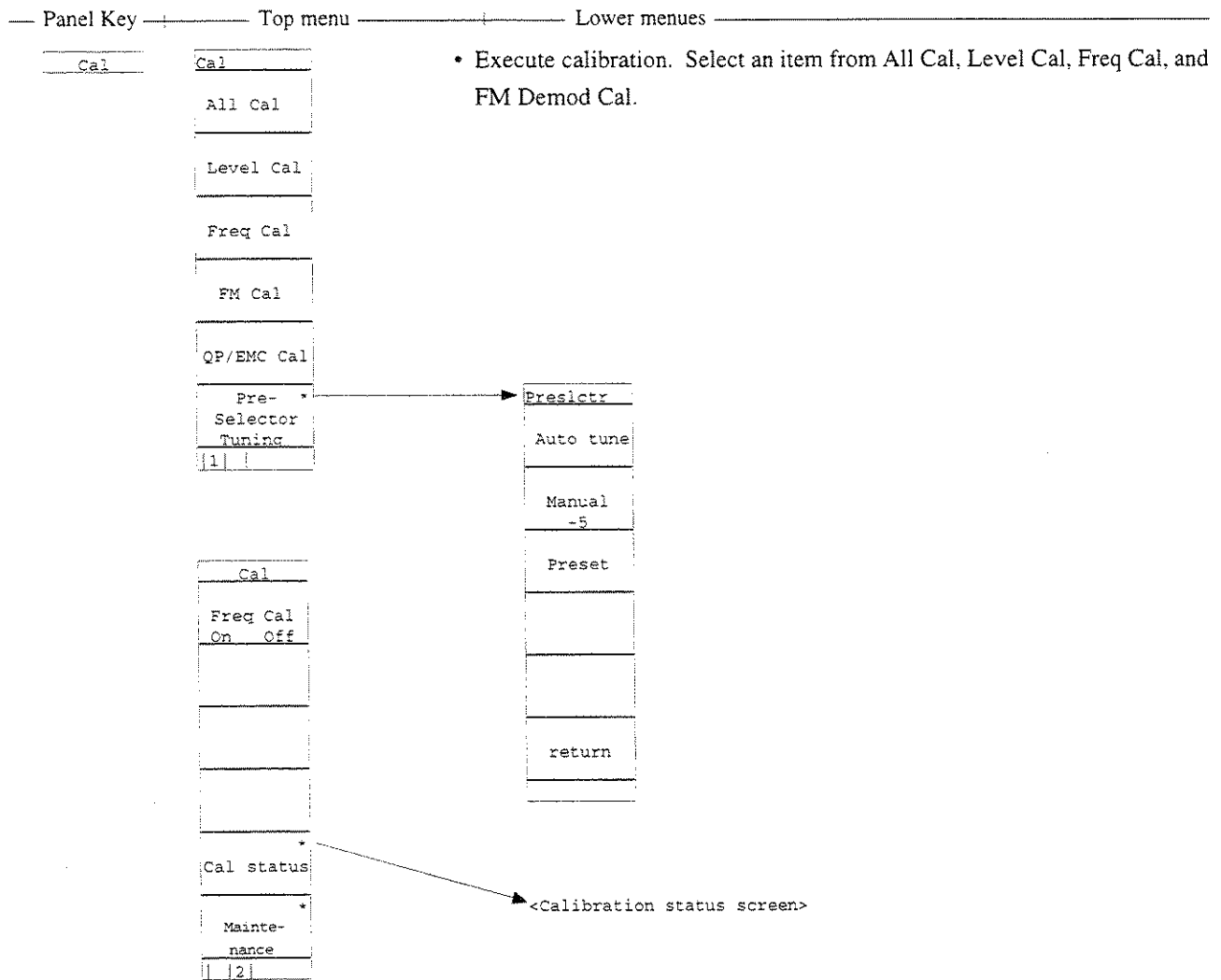

Menu Tree (23/28)

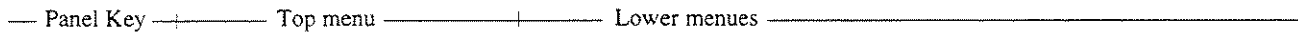

- Set interfaces for external devices to connect. Select RS232C, Centronics or GPIB, and set the RS232C interface, GPIB address, etc.

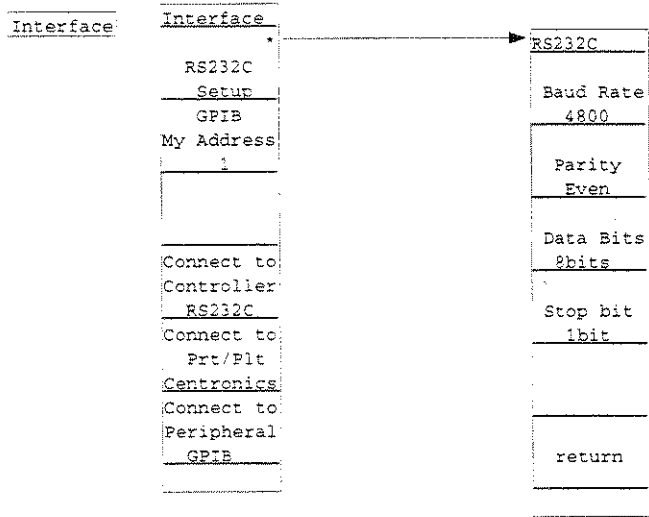

- Input a title to display on the screen.

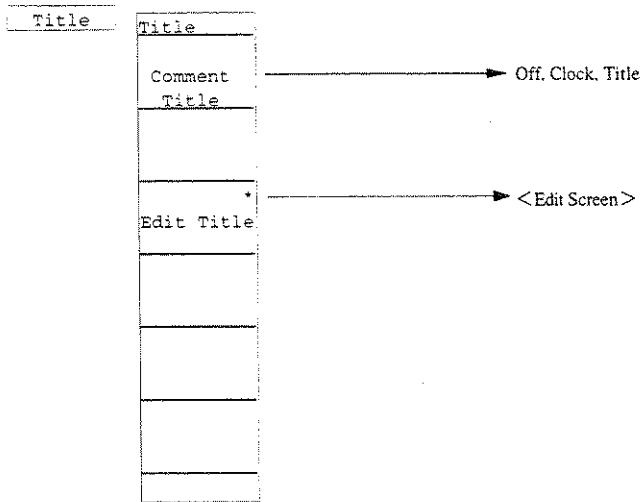



Menu Tree (24/28)

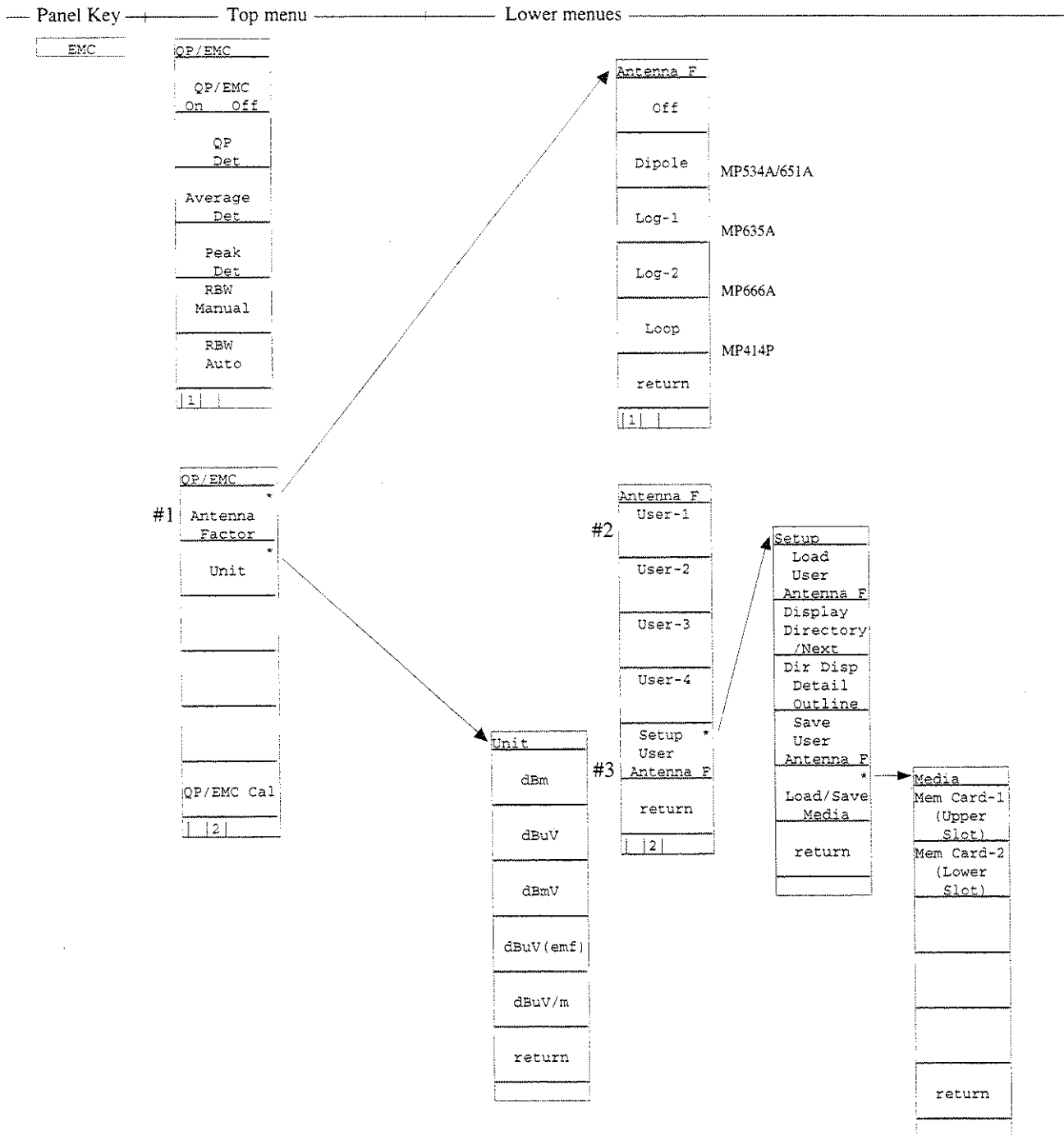

- Set the functions for QP detection/EMC measurement.
  - #1 Correction on the frequency characteristic of the antenna to be used is performed prior to measurements.
  - #2 When an user intends to use an own antenna, measurement is performed using its frequency characteristic correction data.
  - #3 Load/Save a user's antenna correction factor from/to memory card.

Menu Tree (25/28)

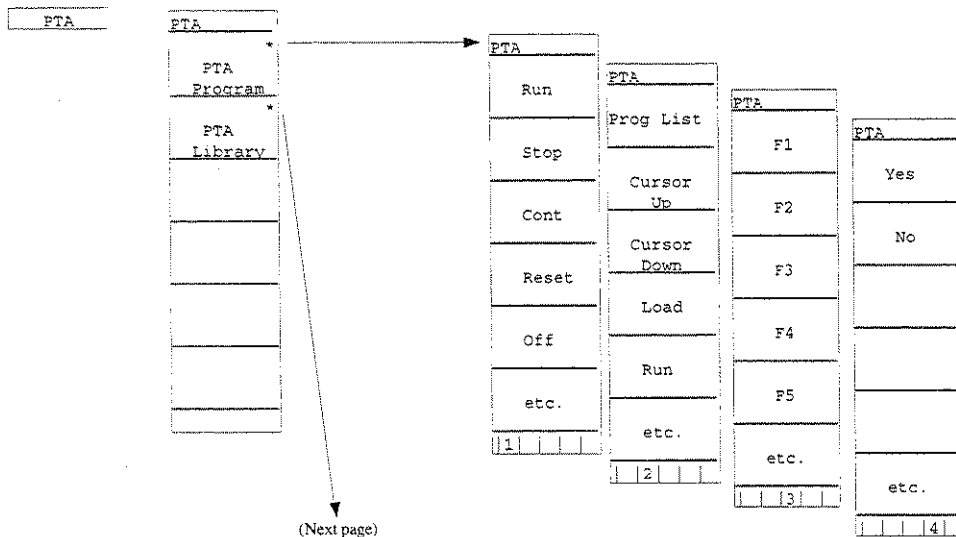
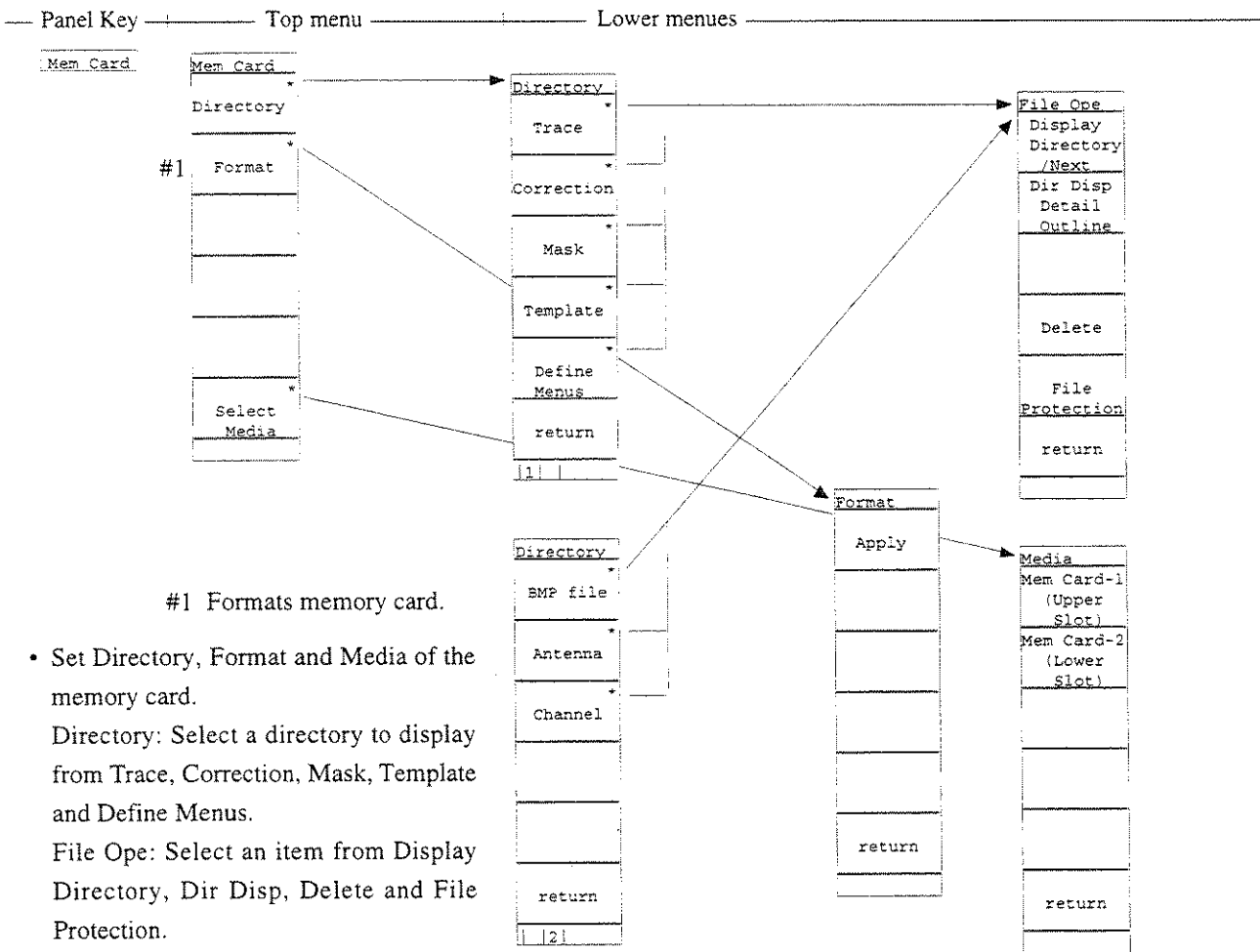

- Set PTA (personal test automation) that can build an auto measurement system without requiring external controllers.
  - PTA Program: Select one from Run, Stop, Cont Reset, Prog List, Load, etc.
  - PTA Library: Select one from Display/Run for the library program and Load/Check for the library file.

Menu Tree (26/28)

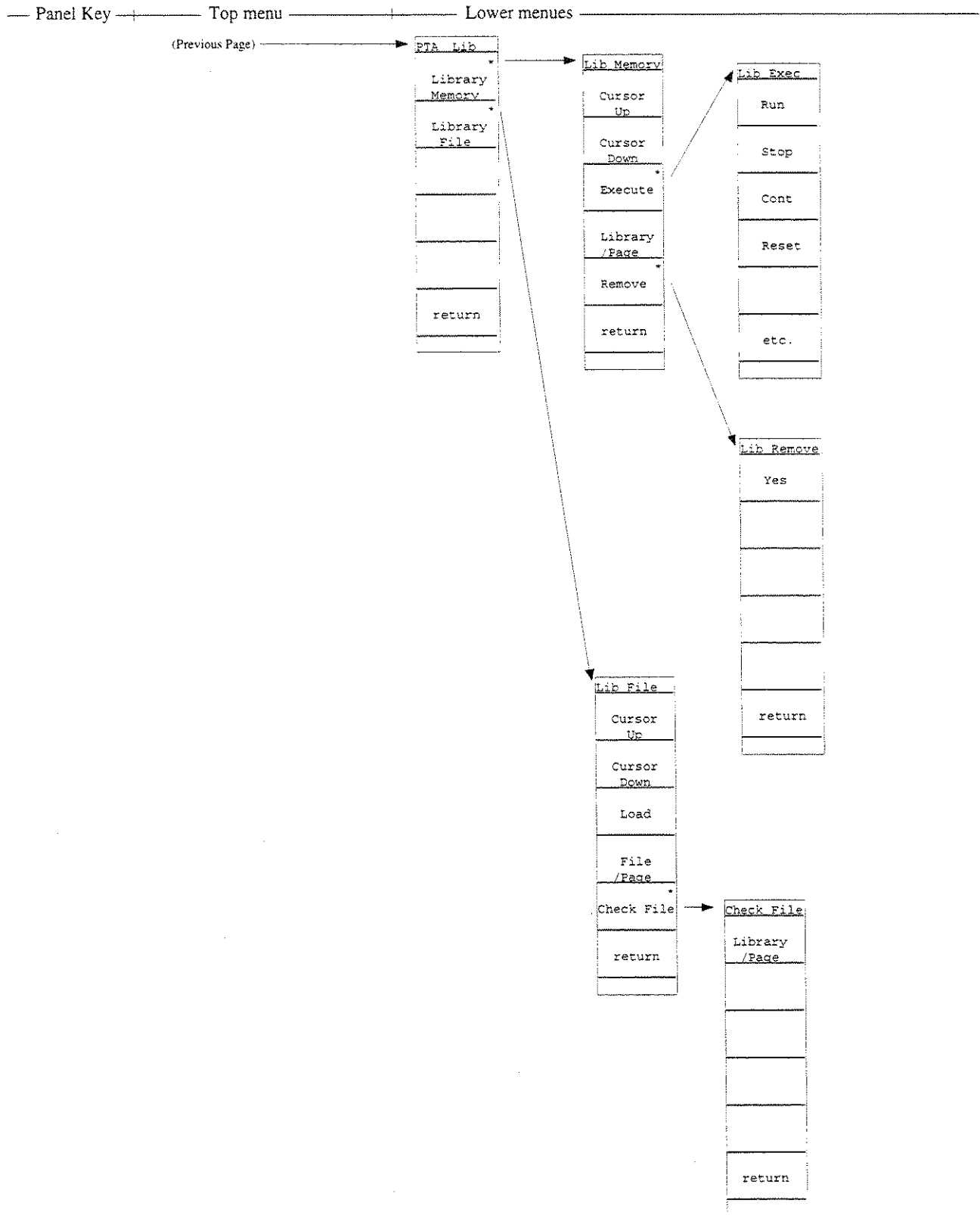

Menu Tree (27/28)

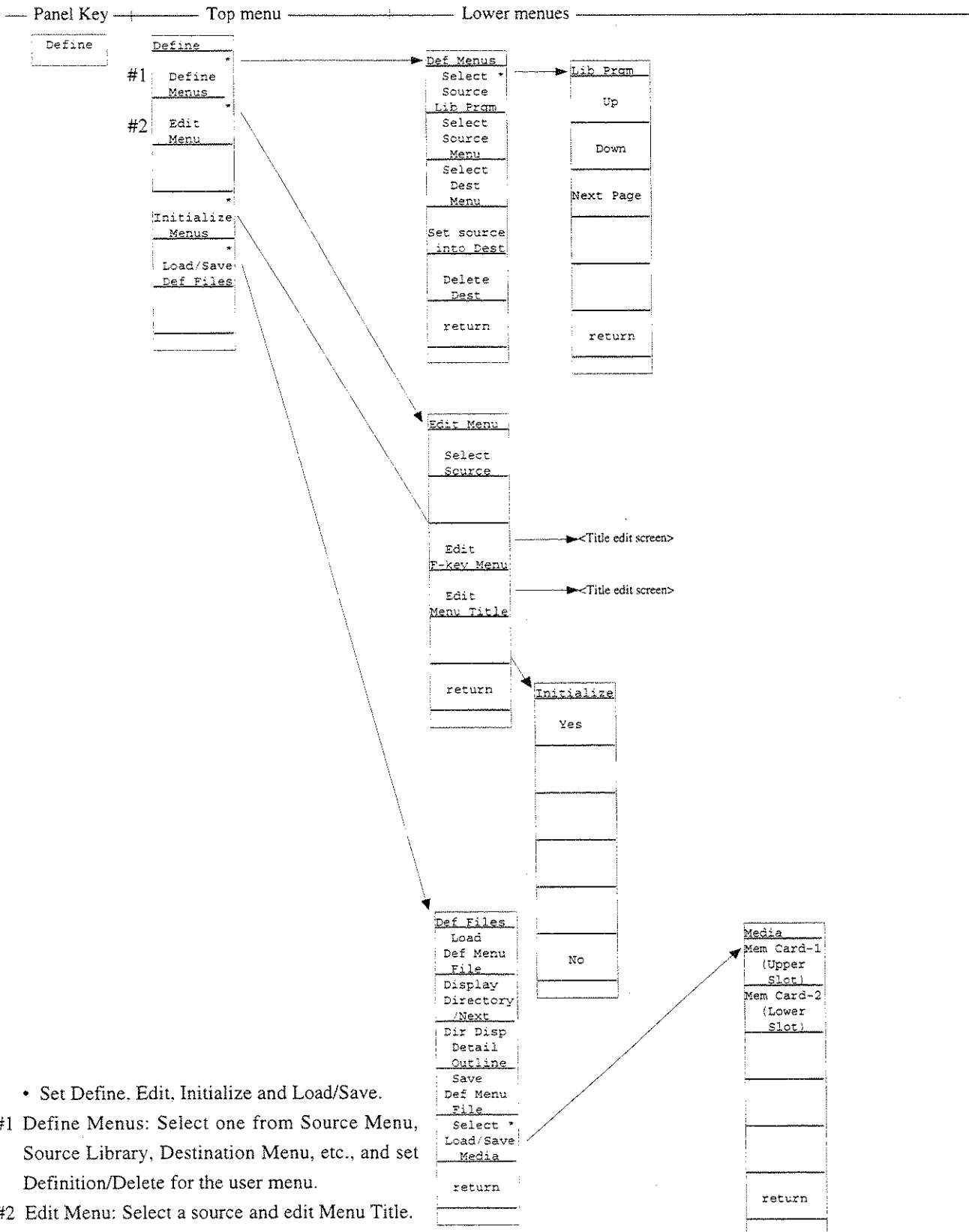

Menu Tree (28/28)

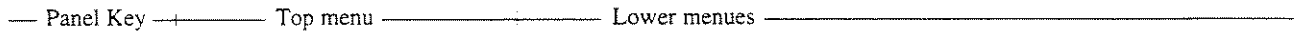

Preset

Preset  
Preset  
All

- Initialize measurement parameters. Select one from All, Sweep, Trace, Level and Freq/Time.

Preset  
Sweep  
controll  
Preset  
Trace  
Parameters  
Preset  
Level  
Parameters  
Preset  
Freq/Time  
Parameters

Hold

Local

## APPENDIX B

### KEYWORDS INDEX

The following lists the main keywords used in this operation manual and the number of the pages on which they are used. Use it to search for the soft keys, function descriptions, etc.

## [KEYWORDS INDEX]

Keyword	Page	Keyword	Page
→ CF	3-22	Auto tune	4-4
→ RLV	3-22	Automatic Calibration Function	8-3
← Scroll	2-6	Automatic Tuning	4-4
1 div	2-6 3-4	A>B	5-9
10%/div, 10dB/div	2-9	A>BG	5-9
50 Ω ,75 Ω	2-15	Average	5-15 5-17 5-18
*	3-14	average value	13-12
A) A on B	5-8	averaging	5-20
A/BG	5-11	Averaging Count	5-18
A/Time	5-14	Averaging Function	5-18
A+B → A	5-6	averaging function	5-19
A-B On Off	5-7	Avg Mode Stop Non-Stop	5-18
A/B, A/BG	5-9	A → B	5-6
A/BG	5-9	A ↔ B	5-6
A<Time	5-14	B) Back Ground (BG)	4-4
Above Below	3-20	Before Power Off	9-9
Abs	3-10	before the trigger	5-12
Absolute Value	3-10 3-12	Below	3-20
AC or DC Coupling	5-30	BG zone	5-4
Active Marker	3-13 3-14	Blue	9-8
Active Trace	5-8	Both Channel	13-27
Active Trace A B	5-8	Bottom	5-7
Address	11-6	Burst Average Power	13-7
add	5-6	Burst Avg Power	13-7 13-13 13-19
Adj ch pwr Measure	13-5	Burst Wave	13-16
Adjacent Channel Leakage Power	13-5 13-26	burst wave	6-16
All Auto	7-4	burst wave gate control signal	6-8
All Cal	8-4	B → A	5-6
All Trace&Parameter	10-9	C) C/N Ratio	13-4 13-8
AM	11-12	C/N Ratio Measure	13-4 13-8
antenna factor	8-6	CAL	8-3
Atten	7-8	Cal Status	8-4
Attenuator	2-15	Calc	5-7
Auto mode	7-5 7-7 7-8	calculates the average data	5-18
Auto Select	3-13	Calibration Function	8-3
Auto SWT	9-10	Carrier-Off	13-21
		Center	2-3
		CF Step Size	2-6
		Ch BW	13-5

Keyword	Page	Keyword	Page
Ch Sepa-1	13-5	DC coupling	5-30
Chack Pass/Fall	13-6	Define	12-6
Change Active Marker	3-13	Define Menues	12-6 12-7
Change Color	9-8	Define User Color	9-8
Change into TV	11-14	Delay Time	5-12 6-10
Channel Assign	11-14	Delete	10-11 12-9
Check File	12-5	Delete Dest	12-7
Check Pass/Fall	13-6	Delta Marker	3-8
Clear	12-9	Delta Mkr → Span	3-24
Clear All	3-14	Demod Coupling AC DC	5-30
Clock Disp	9-6	destination	12-7
Color Patern	9-7	Detail	2-16 10-7 10-8
Comment	11-11	Detecting Peaks	4-3
Conductive jammer Mesurement	15-16	Detection	5-12 5-23
Connect to Controller	11-7	Detection Mode	5-21 5-23
Connect to Prt/Plt	11-7	digital averaging	5-20
Continue	5-10 5-17	Dip	3-9
Continuous	6-3	Dip Search	3-18
Continuous Sweep Mode	6-3	Dir Disp Detail	10-5
Copy	1-9	Dir Disp Outline	10-5
Copy Color Ptn	9-8	Direct Plotting	11-3
Copy Cont	1-9 11-4	Directory	10-10
Corr-1	8-8	Directory Display Screen	10-6
Correction	2-16 8-7	Directory/Next	10-5
Correction Coefficient	2-16	Disp Line Level	3-20
correction factor	8-8	Display	9-6
Count	13-4	Display Directory	2-16 10-5
Coupled Common	9-4	Display Line	3-10 3-20
Coupled Function	7-3	display line	5-7
Coupled Function Common	9-4	display Line display	3-20
Coupled Independent	9-4	Display modes	5-3
Cumulative	5-15 5-17	Display Type	9-6
current marker	3-4 3-7	E) Edit Menu	12-6
Cursor Down	12-4 12-5	Edit Title	11-11
Cursor Up	12-4 12-5	EMC Measurement	15-15
D) Date	9-11	Entry area	1-4
dBc/Hz	13-9	Ewpands and displays	5-12
dBm/ch	13-11	EX1 ~ EX5	12-4
dB $\mu$ V, dBmV	2-8 2-10	Execute	12-5 13-5 13-7



APPENDIX B KEYWORDS INDEX

Keyword	Page	Keyword	Page
Executing Hard Copy	11-8	Gate Trig Source	6-18
Expand	5-12	GP-GL	11-6
Expand On	5-4 5-28	GPIB interface	11-3
Expand zone	5-4	GPIB My Address	11-7
Expand Zone On Off	5-28	Green	9-8
expansion zone	5-28	H) H-Sync	6-9
External	6-8	Harmonics	3-12
External Trigger	6-8	Highest 10	3-11
F) Field Strength Measurement	15-4	Horizontal synchronizing signal	6-9
File	10-11	HP-GL, GP-GL	11-6
file deletion	10-10	HP2225	11-5
File Directory	10-8	I) Impedance transformer	2-15
File/Page	12-5	Independent	9-4
Filter Off	7-7	Initialize Menues	12-6
Fixed State	9-10	Input Impedance	2-15
FM	11-10	Insert	12-9
FM Cal	8-4	instantaneous signal level	5-24
FM Monitor	5-12 5-30	Instant Normalize	14-4
Format	10-10	Interface	1-9 11-7
Freerun	6-5	Item	9-8 11-6
freerun or trigger sweep	5-12	J) Japan	11-14
Freq/Time Abs Rel	3-12	L) Leakage Power Measurement	13-21
Frequency	13-4	Level Abs Rel	3-12
Frequency Count	1-8	Level Cal	8-4
Frequency deviation	5-4 5-30	Level Correction	8-6
frequency domain	5-5 5-6	Level Frequency	2-16
Frequency drift	6-13	Level Frequency Correction Coefficient	2-16
Frequency Measurement	13-4	Level Range	2-8
Frequency range	5-4	Library File	12-5
frequency span to 0	5-26	Line	6-9
Full Size	11-6	Line No.	6-9
Full Span	2-7	Line Trigger	6-9
G) Gate Control Signal	6-17	Linear Scale	2-9
gate cursor	6-19	Load Corr Set	2-16
Gate Delay	6-17 6-19	Load/Save Def Files	12-6
Gate End Int Ext	6-19	Location	11-6
Gate Length	6-19	Locked	9-8
Gate Setup	6-18	log scale	2-9
Gate Sweep On Off	6-18		

Keyword	Page	Keyword	Page
M) MA1621A	2-15	Moving the Trace	5-6
Magnify 1 × 1	11-5	MP614A	2-15
Main Trace	5-9 5-11 5-14	MS-DOS format	10-10
Manual	3-11 7-7	Multi Marker	3-11 3-14
Manual setting	7-5 7-9	Multimarker Off	3-14
marked by an asterisk	1-6	N) N% of Power	13-5 13-16
marker	3-3	Narrow FM	11-12
MARKER FUNCTIONS	3-3	Neg Peak	5-22 5-23 5-24
Marker Level Abs Rel	3-10	Next Dip Search	3-19
Marker List	3-12	Next Left Peak	3-17
Marker Mode	3-7	Next Peak	3-16
Marker Off	3-9	Next Right Peak	3-17
Marker Search	3-9 3-15	Noise Measure	13-4 13-10
Marker Search Peak	3-9	Non-Stop	5-18
Marker Tracking	6-13	Normal	5-15 5-17 5-22
Marker Values	3-21		5-23 5-24
Mask	13-6	Normalize	14-4
MASK Creation Screen	13-34	Normal Marker	3-7
Max Hold	5-15	Normarize (A-B+DL) On	5-7
Measure	1-8 13-3	O) observation of harmonic waves	3-23
measure envelope	5-24	observe power line-related hum waveform	6-9
Measuring Noise Power	13-4	Occ BW Measure	13-5 13-16
Measuring Occupied Bandwidth	13-5	Occupied Frequency Bandwidth	13-16
Media	2-16	off with Auto Select	3-13
Mem Card	10-10	Offsetting	2-13
Memory Card	10-7 13-28	Outline	2-16 10-7 10-8
Memory Directory	10-6	Overwrite	5-8 5-15 5-17
Menu On/Off	1-4	P) page learning function	1-8
Middle	5-7	Paper Feed	11-4
mistake	1-3	Paper Size	11-6
mixer level	7-8	Parameter Display	9-6
Mkr → CF	3-22	Parameter except RFL	10-9
Mkr → CF Step Size	3-23	Pass/Fail Judgment by Mask	13-6
Mkr → RLV	3-22	PDC	13-13 13-32
monitor function	11-12	Peak → CF	4-5
More key	1-6	Peak → RLV	4-5
Move	5-6	Peak search	3-15
Move Mask	13-6	Peak Signal	4-4
Move Template	13-6	phase-locked	9-8
Moving the Measurement Point	4-5		

APPENDIX B KEYWORDS INDEX

Keyword	Page	Keyword	Page
PHS	13-11 13-13 13-29	Remove	12-5
Plot Rocation Reset	11-4	resolution	3-19
Plotter	11-4	resolution dB	3-19
Plotter Address	11-6	Restart	5-10 5-17 6-18
Plotter Setup	11-4	RS-232C interface	11-3
Pos Peak	5-22 5-23 5-24	RS232C Setup	11-7
Post-trigger	6-11	Run	12-4
Power Measurement	13-10 13-12	S) S/N	5-19
Power On State	9-10	S/N improvement	5-20
Pre Ampl	2-15 7-8 11-14	Sample	5-22 5-23 5-24
Pre-trigger	6-11	sample point	5-24
Preamp	2-15	Save	10-5
Preset	1-3	Save Corr Set	2-16
Printer	11-4	Save to Mem Card	10-5
Printer Address	11-5	Saving to Memory	10-5
Printer Setup	11-5	Scroll →	2-6
Prog List	12-4	Scroll Step Size	2-6
Protection	10-11	scrolled and selected	3-13
PTA	12-3	Search	3-20 4-3
PTA Library	12-5	Search Above Below	3-20
PTA Program	12-4	Search Resolution	3-19
PTL language	12-3	Select Corr	2-16 8-7
Q) Quarter Size	11-6	Select Dest	12-7
R) Radioactive Jammer Mesurement	15-16	Select Item	9-8
Range 2kHz/Div	5-30	Select Marker No	3-13
RB, VB, SWT Auto	7-4	Select Mask Table	13-6
RBW	7-4	Select Media	10-10
Recall	10-7	Select Source	12-7
Recall Item	10-7 10-9	Select Temp Table	13-6
Recall Media	10-7	Selecting a Plotter	11-4
Recalling From Memory	10-7	Selecting a Printer	11-4
Red	9-8	Set Date	9-11
Ref	10-9	Set source into Dest	12-7
Ref Level Offset	2-14	Set Time	9-11
Ref Level Step Size	2-12	Setting Interface	11-7
Ref Line	5-7	Setting Parameters	3-21
reference marker	3-8	Setting Reference Level	2-11
Rel	3-10 3-12	Setting Time Domain	5-26
Relative Value	3-12	Setup	13-5
		Setup Corr	2-16 8-7

Keyword	Page	Keyword	Page
SIGNAL SEARCH FUNCTION	4-3	Title	11-11
Signal Tracking	6-13	title edit screen	12-9
Single	6-3	Top	5-7
Single Sweep Mode	6-4	Tr-Time	5-12
small display	5-9	Trace A	5-5 6-18
SOUND	11-12	Trace A on B	5-8
Sound Monitor	11-13	Trace B	5-6
Source	12-7	Trace Calc	5-7
Span	2-3	Trace Computation	5-7
Spot	3-4	trace memories	5-23
spot marker	3-5	Trace move	5-6
Spurious Radiation Strength	13-18	Trace Time	5-4 5-12 6-18
Start	2-3	Tracking	6-13
Start freq	2-5	Tracking Generator	14-1
Start Point	13-7	Trig Level	6-8
Step	2-4	Trig Slope	6-8
Step Size	2-4	Trigger Freerun	5-12
Stop	2-5 5-10 5-17 6-18	trigger level	6-8 6-11 6-17
Stop Continue	5-18	Trigger Mode	6-5
Stop freq	2-5	Trigger Source	5-12
Stop Non-Stop	5-18	trigger source	6-6
Stop Point	13-7	Trigger/Gate	6-6
Stop Print	11-4	Triggered	6-6
Storage Mode	5-15 5-17	Tune	4-4
Strage	5-12 5-17 5-18	TV	6-9 11-12 11-14
Sub Trace	5-11 5-14	TV Monitor	11-14
Sub Trace Write View	5-10	TV Monitoring	11-14
subtracts	5-7	TV NTSC PAL	6-9
Sweep Mode	6-3	TV Trigger	6-9
Sweep Time	7-4	Type-1	9-6
Swp Contl	5-10	U) UNCAL	7-6
system	9-4	Unit	2-10
system parameter	9-3	Unlocked	9-8
SYSTEM SETTING	9-3	unlocked mode	9-8
system variable	12-4	USA	11-14
T) threshold	3-20	User Antenna Factor	15-7
Time Gate Function	6-15	User Color	9-7
Time Span	5-12 5-27	User-Definition Operation	12-8
Time Sweep Locked	9-8		
Time Template	13-6 13-29		

APPENDIX B KEYWORDS INDEX

	Keyword	Page
V)	V	2-8 2-10
	V-Sync	6-9
	VB/RB Ratio	7-7
	VBW	7-7
	Vertical synchronizing signal	6-9
	Video	6-7
	video filter	5-20
	Video Trigger	6-7
	View	5-15 5-17
	Volume	11-12
	VP-800	11-5
W)	W	2-8 2-10 2-11
	Wide FM	11-12
	Wide IF Video	6-8 13-23
	Wide IF Video Trigger	6-8 6-14
	write protect	10-10
X)	XdBDown mode	13-5
Y)	Yes No	12-4
Z)	Zero Span	2-7 5-26
	Zone Marker	3-4
	zone marker	3-25 5-28
	zone marker width	3-5 3-25
	Zone → Span	3-25
	Zone Span Point	5-28
	Zone Start Point	5-28
	Zone Sweep	6-12
	Zone Width	3-4

# Anritsu Service and Sales offices

## America

### Anritsu Company (ACUS)

685-A Jarvis Drive Morgan Hill, CA  
95037-2809, U.S.A.  
Phone: +1-408-776-8300  
Fax: +1-408-776-1738

### Anritsu Company (ACUS-NJ) Dist.5

10 New Maple Avenue, P.O. Box 836  
Pine Brook, NJ 07058-0836, U.S.A.  
Phone: +1-973-227-8999  
Fax: +1-973-575-0092

### Anritsu Company (ACUS-Maryland) Dist.6

19630 Club House Road, #710  
Gaithersburg, MD20879, U.S.A.  
Phone: +1-301-590-0300  
Fax: +1-301-216-2893

### Anritsu Company (ACUS-Tx) NARO

1155 East Collins Blvd  
Richardson, TX 75081, U.S.A.  
Phone: +1-972-644-1777  
Fax: +1-972-644-3416

### Anritsu Electronics Ltd (ACCA)

5A-245 Matheson Blvd. East, Mississauga,  
Ontario, L4Z 3C9, Canada  
Phone: +1-905-890-7799  
Fax: +1-905-890-2290

### Anritsu Electronics Ltd (ACCA)

102-215 Stafford Road West Nepean,  
Ontario, K2H 9C1, Canada  
Phone: +1-613-828-4090  
Fax: +1-613-828-5400

### Anritsu Electronics Ltd (ACCA)

200-1405 Trans Canada Highway  
Dorval, Quebec H9P 2V9, Canada  
Phone: +1-514-421-3737  
Fax: +1-514-685-9839

### Anritsu Electronics Ltd (ACCA-Calgary)

Deerfoot Atrium, Suite 129, 6715-8th Street  
N.E., Calgary, AB, T2E 7H7, Canada  
Phone: +1-403-275-9855  
Fax: +1-403-275-3609

### Anritsu Eletrônica Ltd (ACBR)

Praia de Botafogo, 440-Sala 2401  
CEP 22250-040, Rio de Janeiro, RJ, Brasil  
Phone: +55-21-5276922  
Fax: +55-21-537-1456

### Anritsu Eletrônica Ltd (ACBR) Sao Paulo Branch Office

Praca Amadeu Amaral 27,  
Primera Andar, Conj. 11, 12, 13, 14  
Liberdade, Sao Paulo, Estado de  
Sao Paulo, CEP : 01327-010, Brasil  
Phone: +55-11-283-2511  
Fax: +55-11-288-6940

### Data Lab S.R.L

Edif. Ayfra, Pdte. Franco y Ayolas  
Asuncion, Paraguay  
Phone: +595-21-443-046  
Fax: +595-21-441+935

### Electro-Impex S.A.

P.O. Box 620-1000, San Jose, Costa Rica  
Phone: +506-2-31-5701  
Fax: +506-2-31-6531

### Electronica 2000, S.A. DE C.V.

Bldv. Adolfo Lopez Mateos No.2016, Col.  
Tlacopac, Del. Lopez Mateos, 01010,  
Mexico D.F.  
Phone: +525-662-8800  
Fax: +525-662-5862

### Electronic Engineering S.A.

Carretera de Circunvalacion, Sabanilla, Av  
Novena, San Jose, Costa Rica  
Phone: +506-2-25-8793  
Fax: +506-2-25-1286

### HDM Elquitcnica Cia. Ltda., Equitronics S.A.

Av. Republica de El Salvador, No.880,  
Edificio, Almirante Colon 4to piso,  
Quito, Ecuador  
Phone: +593-9-704890  
Fax: +593-2-48-2627

### KRM Ingenieria Socias.

Viamonte 377,7' Piso 1053 Buenos Aires,  
Argentina  
Phone: +54-1-311-4165  
Fax: +54-1-311-2297

### SI Ltda.

E. Conchy Y Toro 65, Casilla 51888,  
Santiago, Chile  
Phone: +56-2-696-7534  
Fax: +56-2-696-9665

### Radiocom S.A.

Carrera 21 No.85-71, Conmutador  
6100077, Santafe de Bogota, Columbia  
Phone: +57-1-218-2054  
Fax: +57-1-610-3272

### Radiocomunicaciones cruz C.A.

Avda La Colina QTA. Elison, URB Colina  
De Los Caobos, Caracas, Venezuela  
Phone: +58-2-793-2322  
Fax: +58-2-793-3429

### Sakata Ingenieros S.A.

Av. Canaval Moreyra 840, Lima 27, Peru  
Phone: +51-1225-7555  
Fax: +51-1224-8148

### Suministros Industriales S.A.

Casa 102, Calle 68 Este,  
San Francisco, Balboa, Panama  
Phone: +507-270-2328  
Fax: +507-270-2329

### Cabonorte S.A.

Colonia 1900, ESC. 603,  
Montevideo, Uruguay  
Phone: +598-2-430522  
Fax: +598-2-418594

## Europe

### Anritsu Ltd (ACUK)

200 Capability Green, Luton  
Bedfordshire, LU1 3LU, United Kingdom  
Phone: +44-1582-433200  
Fax: +44-1582-731303

### Anritsu Ltd (ACUK-Manchester)

Kansas Avenue, Langworthy Park Salford,  
Manchester M5 2GL, United Kingdom  
Phone: +44-161-873-8041  
Fax: +44-161-873-8040

### Anritsu Ltd (ACUK-Bristol)

1230 Aztec West, Almondsbury  
Bristol BS12 4SG, United Kingdom  
Phone: +44-1454-615252  
Fax: +44-1454-618017

### Anritsu Ltd (ACUK-Livingston)

Unit 1, Knightsridge Industrial Estate  
Tumbull Way, Knightsridge Livingston  
EH54 8RB, United Kingdom  
Phone: +44-1506-436111  
Fax: +44-1506-436112

### Anritsu GmbH (ACDE)

Grafenberger Allee 54-56  
D-40237 Düsseldorf 1, Germany  
Phone: +49-211-96855-0  
Fax: +49-211-96855-55

### Anritsu GmbH (ACDE-Sales Center South)

An der Steinernen Brücke 1 D-85757  
Karlshof, Germany  
Phone: +49-8131-3825-0  
Fax: +49-8131-3825-95

**Anritsu S.A. (ACFR)**

9, Avenue du Québec ZA de  
Courtaboeuf 91951 Les Ulis Cedex,  
France  
Phone: +33-1-60-92-15-50  
Fax: +33-1-64-46-10-65

**Anritsu S.A. (ACFR)  
(Toulouse Office)**

Bureau de Toulouse  
Région Centre Sud Ouest  
Phone: +33-5-62070484  
Fax: +33-5-62070668

**Anritsu S.A. (ACFR)  
(Toulon Office)**

Bureau de Toulon  
Région Centre Sude Est  
Phone: +33-4-94040264  
Fax: +33-4-94040265

**Anritsu S.A. (ACFR)  
(Rennes Office)**

Bureau de Rennes  
Région Ouest  
Phone: +33-2-99521214  
Fax: +33-2-99521224

**Anritsu S.p.A. (ACIT)**

Via Elio Vittorini, 129  
00144 Roma EUR, Italy  
Phone: +39-06-509-9711  
Fax: +39-06-502-2425

**Anritsu S.p.A (ACIT-Milano)**

C.D. Colleoni, Via Paracelso, 420041  
AGRATE B.ZA(MI), Italy  
Phone: +39-039-65-7021  
Fax: +39-039-605-6396

**Anritsu AB (ACSE)**

BOTVID CENTER  
145 84 STOCKHOLM, Sweden  
Phone: +46-8-53470700  
Fax: +46-8-53470730

**Anritsu AB-Norway Branch  
Office (ACNO)**

Leangbukta 40 1370 Asker, Norway  
Phone: +47-66-901190  
Fax: +47-66-901212

**Anritsu AB-Finland Branch  
Office (ACFI)**

Piispanportti 9 FIN-02240 Espoo, Finland  
Phone: +358-9-435-522-0  
Fax: +358-9-435-522-50

**Anritsu AB-Denmark Branch  
Office (ACDK)**

SOHOJ 11, DK-2690 KARLSLUNDE  
Denmark  
Phone: +45-46160330  
Fax: +45-46155299

**C.N. Rood B.V.**

Cort van der Linddenstraat 11-13, 2288  
EV Rijswijk ZH, The Netherlands  
Phone: +31-70-3996360  
Fax: +31-70-3905740

**C.N. Rood SA/NV**

Pontbeeklaan 45, 1731 Zellik, Belgium  
Phone: +32-2-4668199  
Fax: +32-2-4662500

**ELSINCO GMBH**

h.e. Strelbishte, str. Kotelnski Prohod, bl.  
96/6/14, BG-1408 Sofia, Bulgaria  
Phone: +359-2-58-61-31  
Fax: +359-2-58-16-98

**ELSINCO Praha Spol.**

Novedvorska 994, CZ 142 21 Praha  
4-Branik, Czecho Republic  
Phone: +42-2-49-66-89  
Fax: +42-2-49-54-83

**ELSINCO Budapest KFT**

Pannonia utca 8. IV/I.  
H-1136 Budapest, Hungary  
Phone: +36-1-269-18-50  
Fax: +36-1-132-69-27

**ELSINCO Polska Sp. Z.O.O**

ul. Dziennikarska 6/1, PL 01 605  
Warszawa, Poland  
Phone: +48-22-39-69-79  
Fax: +48-22-39-44-42

**ELSINCO Bratislava Spol. s.r.o.**

Kudlakova 4, SK 844 15 Bratislava,  
Slovakia  
Phone: +42-7-784-165  
Fax: +42-7-784-454

**G'Amungason Co.**

Skulagata 40, 101 Reykjavik, Iceland  
Phone: +354-1-677887  
Fax: +354-1-625045

**GMP S.A.**

Av. des Baumettes 19, CH-1020 Renens  
1 Lausanne, Switzerland  
Phone: +41-21-6348181  
Fax: +41-21-6353295

**Instrutek Oeriferi A/S**

Christiansholmegade DK-8700 Horsens,  
Denmark  
Phone: +45-75-611100  
Fax: +45-75-615658

**Kostas Karayannis SA**

58, Kapodistriou str., GR-142 35 Nea Ionia,  
Athens, Greece  
Phone: +30-1-680-0460-4  
Fax: +30-1-685-3522

**Omnitecnica S.A.**

Estrada Alfragide 2700 Amadora, Portugal  
Phone: +351-1-471-55-17  
Fax: +351-1-471-36-10

**Pema Ltd.**

Doromiskin, Dundalk, Co. Louth, Ireland  
Phone: +353-42-72899  
Fax: +353-42-72376

**Unitronics S.A.**

Plaza Espana 18, Torre de Madrid,  
Pl. 12-ofc. 9, 28019 Madrid, Spain  
Phone: +34-1-5425204  
Fax: +34-1-5591957

**Wien CHALL GMBH**

Krichbaumgasse 25, 1120 Wien, Austria  
Phone: +43-1-811-55140  
Fax: +43-1-811-55180

**Asia, Pacific  
and Africa****Anritsu Private Ltd (ACSG)**

6, New Industrial Rd., #06-01/02  
Hoe Huat Industrial Building  
Singapore 536199  
Phone: 65-282-2400  
Fax: 65-282-2533

**Anritsu Company Ltd (ACHK)**

Suite 719, 7/F., Chinachem Golden Plaza,  
77 Mody Road, Tsimshatsui  
East, Kowloon, Hong Kong  
Phone: +852-2301-4980  
Fax: +852-2301-3545

**Anritsu Company Incorporated  
(ACTW)**

6F, 96, Sec. 3, Chien Kou North Rd.  
Taipei, Taiwan  
Phone: +886-2-2515-6050  
Fax: +886-2-2509-5519

**Anritsu Corporation, Ltd (ACKR)  
Head Office**

14F Hyunjuk Bldg. 832-41,  
Yeoksam-dong, Kangnam-ku,  
Seoul, Korea  
Phone: +82-2-553-6603  
Fax: +82-2-553-6604~5

**Anritsu Proprietary Ltd (ACAU)**

Unit 3, 170, Forster Rd., Mt. Waverley  
Victoria 3149, Australia  
Phone: +61-3-9558-8177  
Fax: +61-3-9558-8255

**Anritsu Proprietary Ltd (ACAU)**

Suite 304/2 Rowe Street Eastwood  
NSW 2122, Australia  
Phone: +61-2-9874-9044  
Fax: +61-2-9874-9920